

avocor



A-Series User Manual

For Models AVA-6520, AVA-7520, AVA-8620

Table of Contents

Table of Contents.....	2
Caution :.....	3
Caution: 	3
Important safeguards for customers and their products :.....	3
Notice :.....	3
1.2 Maintenance	6
2. Introduction.....	7
<u> </u> Camera Module Assembly Instructions	10
3. Product description	15
4. Remote controller.....	16
5. System Settings.....	18
6. Whiteboard	133
10.5. External Control.....	188
11. Troubleshooting.....	18891
Avocor: Three-year Limited Warranty.....	193

Information to user:

Changes or modifications not expressly approved by the party responsible for compliance could void the user's authority to operate the equipment.

Note: This equipment has been tested and found to comply with the limits for a Class A digital device, pursuant to part 15 of the FCC Rules. These limits are designed to provide reasonable protection against harmful interference when the equipment is operated in a commercial environment. This equipment generates, uses, and can radiate radio frequency energy and, if not installed and used in accordance with the instruction manual, may cause harmful interference to radio communications. Operation of this equipment in a residential area is likely to cause harmful interference in which case the user will be required to correct the interference at his own expense.

This equipment complies with FCC RF radiation exposure limits set forth for an uncontrolled environment. This equipment should be installed and operated with a minimum distance of 20 centimeters between the radiator and your body.

Compliance information:

Supplier's Declaration of Conformity:

This device complies with part 15 of the FCC Rules. Operation is subject to the following two conditions: (1) This device may not cause harmful interference, and (2) this device must accept any interference received, including interference that may cause undesired operation.



Responsible Party:

Avocor Technologies USA, Inc.
9375 SW Commerce Circle, Suite A7
Wilsonville, OR 97070, USA
<https://www.avocor.com>

Warning: Operation of this equipment in a residential environment could cause radio interference.

Note: The Product Information could be found at the label.

1. Important safety instructions

icon	Name	Meaning
	Warning	In case of electric shock, serious injury or death
	Caution	Minor injury or damage may occur

Please read this manual carefully before operating the product.

Caution :

The product may differ depending on the model, and specifications are subject to change without notice for improvement.

Warning :

- To reduce the risk of fire or electric shock, do not expose this product to rain or moisture.
- To prevent injury, this product must be securely attached to the floor/wall in accordance with the installation instructions.
- To reduce the risk of electric shock, do not remove the back cover.
- Refer to qualified service personnel if needed.

Caution:

Any unauthorized damage to the inner side of the monitor will void the warranty. The manufacturer does not warrant against damage caused by improper maintenance and repair work by others.

Important safeguards for customers and their products :

Product has been tested to be safe in manufactured. However, improper use may result in electric shock or fire hazard. In order to implement the safety device built into the new product and to prevent accidents, careful read the user's manual and install it. Following safety precautions and keep it for future use.

Notice :

Display is not certified for use in patient diagnostics. It is the responsibility of the hospital or clinic to be used for the right diagnosis products. DICOM is a registered trademark of NEMA for standard publications Related to digital communication of medical information. The "IPS" mark/trademark and technology related patents are owned by their respective owners.

1.1 Safety precautions

1.1.1 Read the instruction manual carefully

1.1.2 Follow the instruction manual

- All operations must follow the instructions in the instruction manual.

1.1.3 Maintenance of user manual

- The instruction manual should be kept for future reference.

1.1.4 Warning

- All warnings in the product and user manual instructions must be followed.

1.1.5 Cleaning

- Disconnect power before cleaning.
- Do not use abrasives. Do not use wet towels.
- ① Do not use any sharp object, except the included stylus.
 - Doing so may cause product damage or failure.
- ② Do not use chemicals such as wax, benzene, alcohol, thinner, pesticides or lubricants.
 - Doing so may cause product damage or failure.
- ③ When cleaning the screen, do not spray approved liquid cleaners directly onto the screen. Instead, spray onto a soft cloth prior to wiping the screen.
 - Otherwise, liquid may enter the product and cause damage or failure.
- ④ When cleaning products with sensor filters attached to the top, bottom, left, and right sides of the screen.
 - Do not apply excessive shock or force to the sensor filter. If the sensor filter is damaged, it may cause product failure.
 - Do not use water, but use a soft brush to remove dust. If the sensor filter gets wet, it may cause product failure.

1.1.6 Water and moisture

- Do not use the product near water or in a humid place.

1.1.7 Precautions for transporting

- Product and cart combinations must be moved with care. If you stop quickly or apply too much force in uneven ground areas, the product and cart may turn upside down.

1.1.8 Ventilation

- Do not block the ventilation.

1.1.9 Power source

- This product must comply with the power rating specified on the rear label.

1.1.10 Grounding the power cord

- This product is equipped with a 3-wire grounding type cord for safety. Do not remove the grounding terminal.

1.1.11 Protecting the power cord

- Make sure the power is properly connected.
Check that the plug and power cable are not twisted or pressed by other objects.

1.1.12 Lightning

- Unplug this product during lightning storms or when unused for long periods of time.

1.1.13 Grounding the product

- This product must be properly grounded to comply with the safety regulations of the country of use. If you are unsure of these regulations, please contact a qualified engineer.

1.1.14 Service

- Do not try to repair the product by yourself. If removing covers may expose you to hazardous voltages or other hazards. Refer all servicing to qualified service technicians.
- If the product do not work properly, turn off the power and contact your dealer.

1.1.15 Services caused damage to property

- Disconnect this product from the power supply and contact service representative under the following situations.

- ① The power cord or plug is damaged.
- ② The protective glass is damaged.
- ③ There is water ingress between the protective glass and the LCD screen.
- ④ If the product has been dropped or the case has been damaged.
- ⑤ Product's performance shows a noticeable change.

1.1.16 Safety checks

- Upon completion of repair or service of this product, inquire the service technician to check that the product is operating normally, for damage and scratch to the front side, and to perform a safety check.

1.1.17 Installation

- It is recommended to mount this product on a wall or rolling cart rated for the weight of the display.

1.1.18 Power

- This product operates on AC power and must use the voltage indicated on the label. The power cord must be always grounded.

1.1.19 Location

- Do not install in unstable place, and secure enough space for safe use.



Warning :Due to the risk of electric shock internally, do not open the cover (or back panel). If the product is present, call for service.



1.2 Maintenance

1.2.1 Exterior and screen care

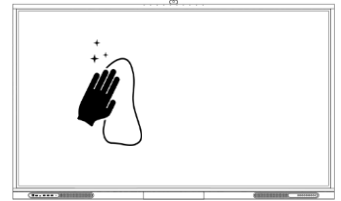
- ① Wipe with a soft, dry cloth.
 - ② Do not wipe with flammable materials such as benzene, thinner, or wet rags.
This will cause a failure.
 - ③ Do not scratch the screen with your fingernails or sharp objects.
This can leave scratches or damage the product.
 - ④ Do not spray water directly on each part of the product body to clean it.
Water in the product can cause fire, electric shock, and failure.
 - ⑤ High-gloss models, due to the nature of the product, require an ultrasonic humidifier.
The product might have white stains.
- ▷ Appearance and color may vary depending on the model.



1.2.2 Installation

- ① Leave some space around the product for good ventilation.
Due to the increased temperature inside the product, It can cause fire and product failure.
 - ② Install it so that at least the space shown in the figure is maintained.
- ▷ Appearance may vary depending on the product.

When installing with a stand

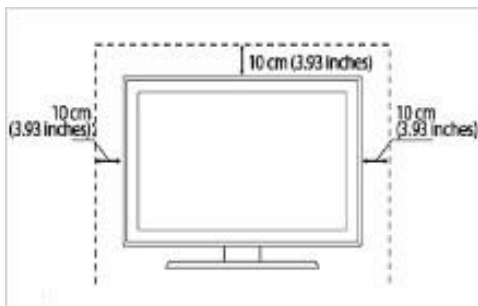

When mounting on a wall (Wall-mount)

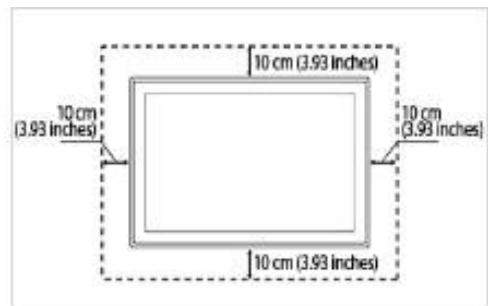

1.2.3 Image retention

- Avoid displaying a fixed image on the screen for a long period of time to prevent image sticking.
Recommend to power off or set the power saving mode when not in use for a long time.

1.2.4 Condensation and humidity for usage

- When using the product for the first time or after a long period of inactivity, condensation may form on the inner glass surface of the screen due to the difference between the external and internal temperatures.







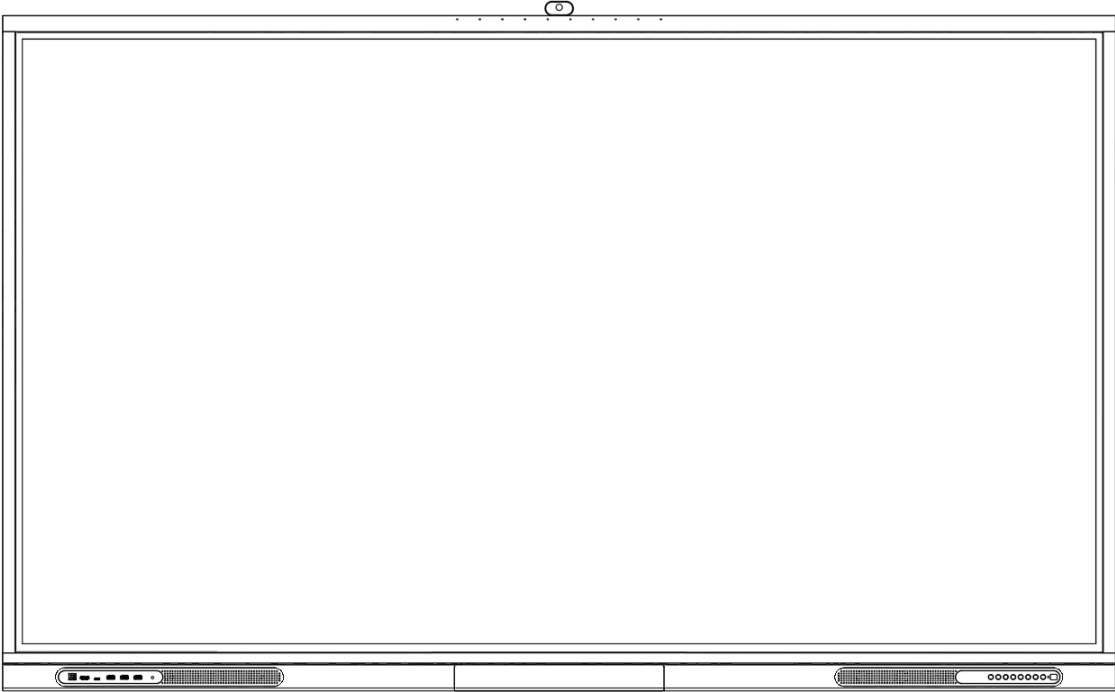

This is a temporary phenomenon caused by the temperature difference between external and internal of the product, which is not malfunctioning. If the symptom occurs, it disappears after a certain time (about 1 ~ 3 hours) after turning on the product.

2. Introduction

2.1 Components

- ① Check components for the following items.
- ② If there are any missing accessories, contact the local dealer where you purchased from.
- ③ The illustrations in this manual may differ from the actual product and components.



Accessories	 <p>POWER CORD</p>	 <p>HDMI CABLE</p>	 <p>TOUCH CABLE</p>
	 <p>REMOTE CONTROLLER</p>	 <p>PEN</p>	 <p>NFC CARD</p>
	 <p>ERASER</p>	 <p>WALL MOUNT</p>	 <p>4K CAMERA MODULE</p>

3. Product description

3.1 Front view

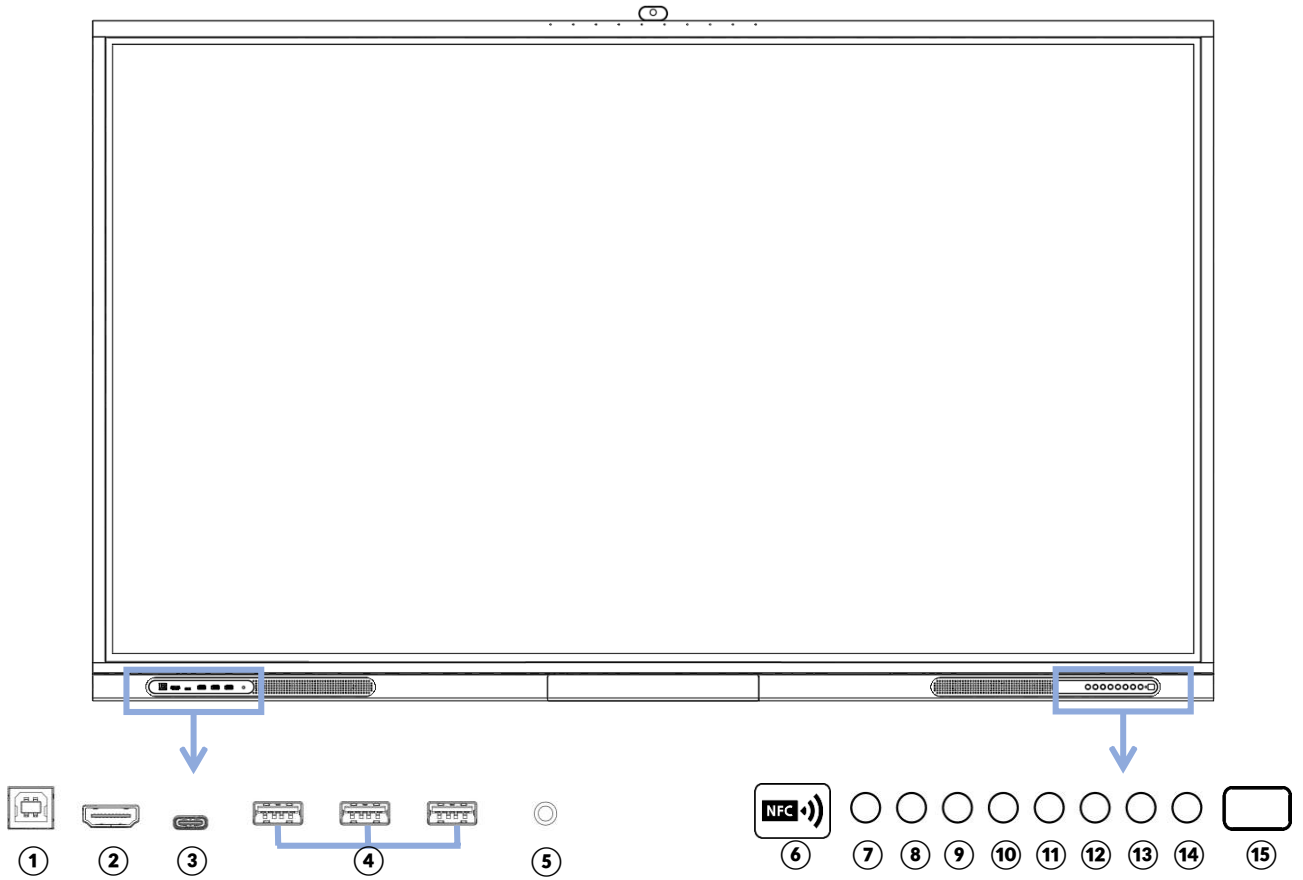

①	FRONT TOUCH (USB-B Type)	⑨	BACK
②	FRONT HDMI	⑩	SOURCE
③	USB C (Video And Audio Support)	⑪	FREEZE
④	USB 3.0	⑫	CAPTURE
⑤	LIGHT SENSOR	⑬	VOL -
⑥	NFC POWER ON / OFF (CARD & APPLICATION)	⑭	VOL +
⑦	POWER ON / OFF SWITCH, POWER INDICATOR (ON : BLUE, OFF : RED)	⑮	REMOTE CONTROL RECEIVER
⑧	HOME		

3. Product description

3.2 Front camera & microphone (Option)

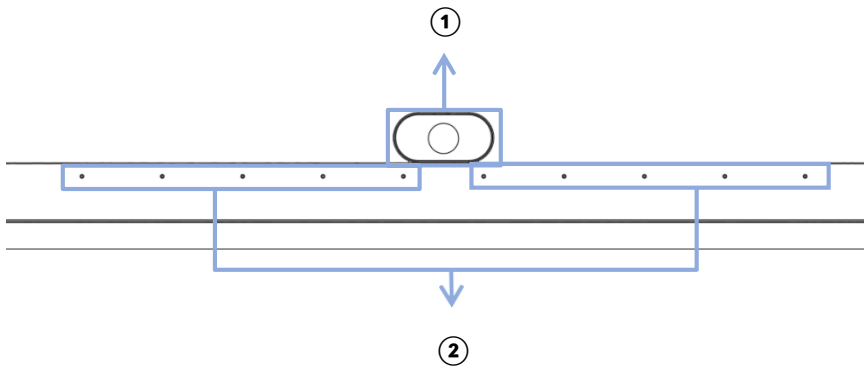
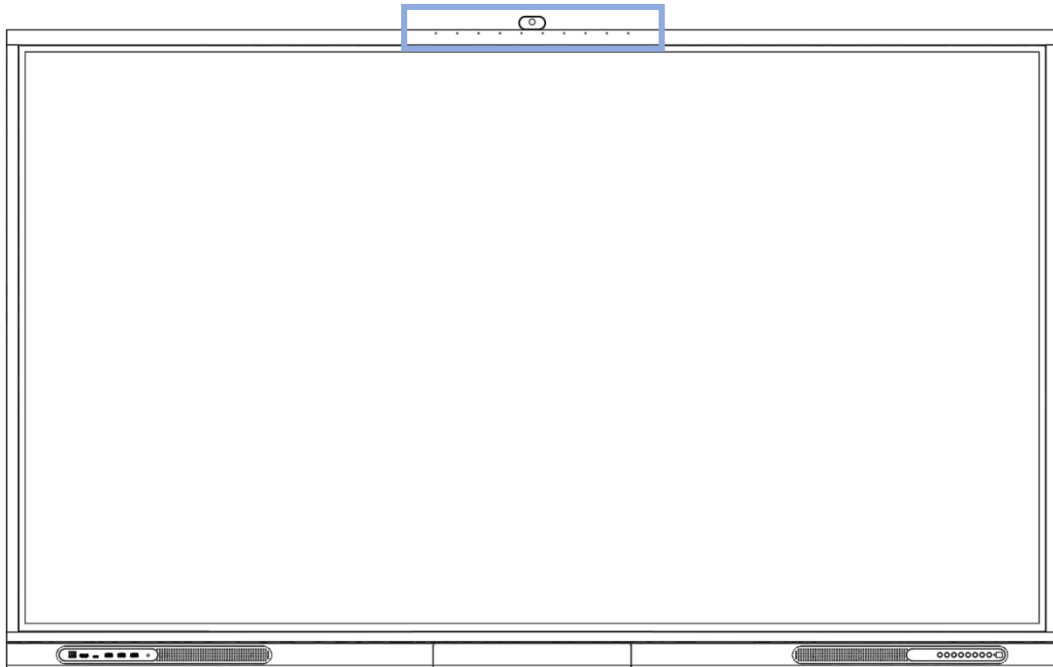

①	Camera 4K Resolution / 123° Field Of View / Auto-Framing / Noise Reduction
②	10-Channel Array Microphones / AI algorithm support

< Notification >

- The USB cable(3m) provided for front USB for Touch Output. Due to limitations in the USB standard, we recommend that the length of USB cables are less than 3m (10ft) to ensure optimum performance.

3. Product description

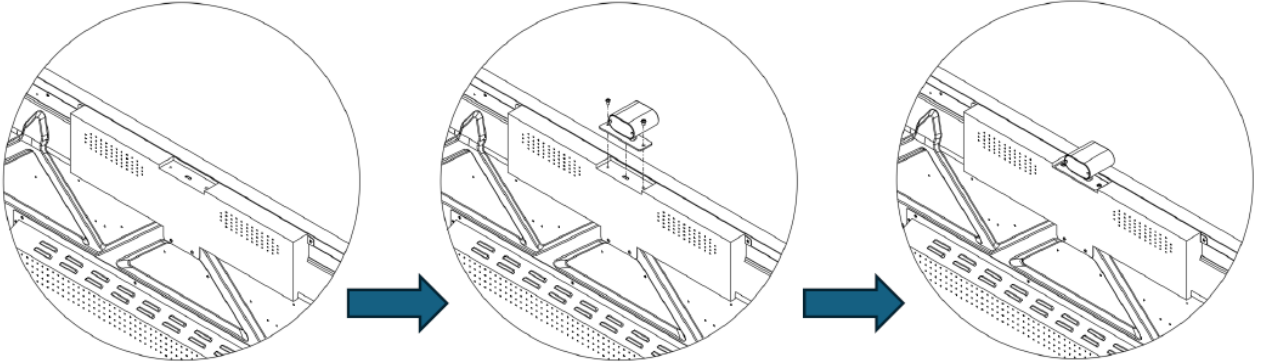

3.2 Front camera & microphone (Option)

Camera Module Assembly Instructions

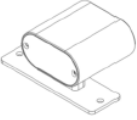

STEP 1 : Place the camera module in the upper center of Product (IFPD)

STEP 2 : Find and use 2 enclosed screws to secure the camera module

	#1 Camera module	1 EA
	#2 Screw (PWH M3x6)	2 EA

3. Product description

3.3 Rear view

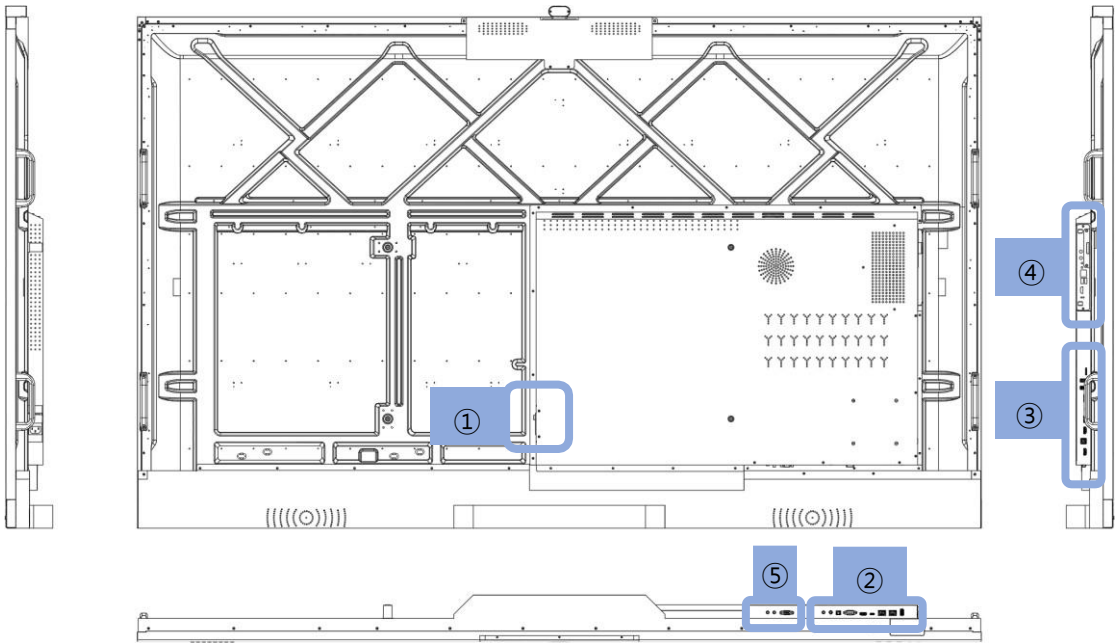

① Power control and AC input

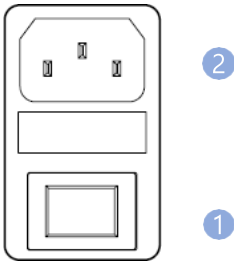

1	Power switch (I: On, O: Off)
2	AC IN 100V~240V 50/60Hz

② Rear panel connectors

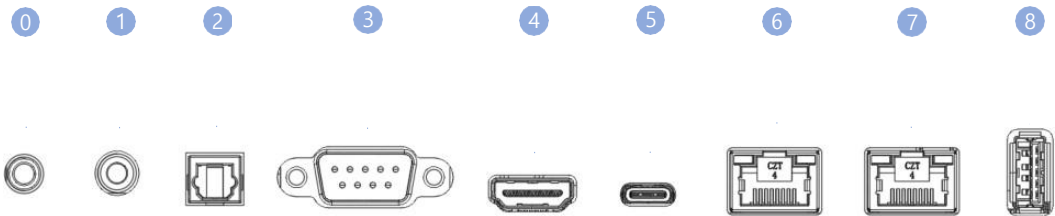

0	MIC input
1	LINE OUT
2	S/PDIF Output
3	RS-232C
4	HDMI Output

5	USB C Output
6	LAN Input/Output 1
7	LAN Input/Output 2
8	USB 3.0

③ Rear panel connectors

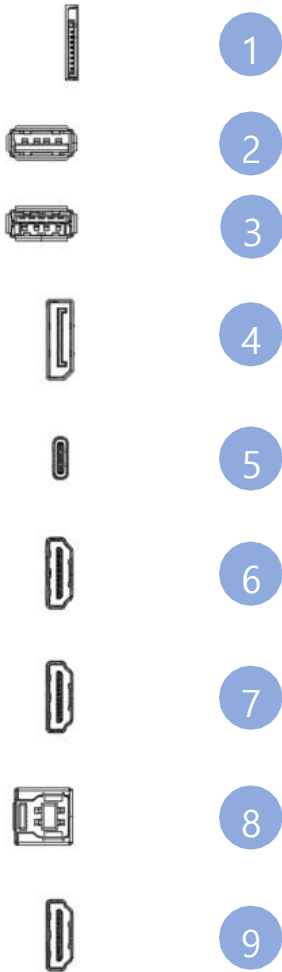

1	SD CARD
2	USB 2.0
3	USB 3.0
4	DISPLAY PORT Input
5	USB C Input
6	HDMI Input 3
7	HDMI Input 2
8	USB Touch (B-Type)
9	HDMI Input 1

④ Installing an OPS

1. Ensure that the display is turned off.
2. Use a Philips screwdriver to unscrew the OPS slot shield on the display input panel. Do not lose the screws that are removed.

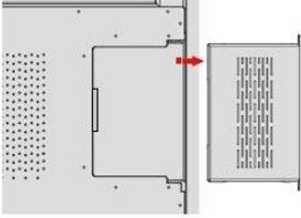

3. Install the OPS module by sliding it into the OPS slot until you hear a click, indicating the module is securely inserted. When using an Avocor OPS PC, the fan should be visible.

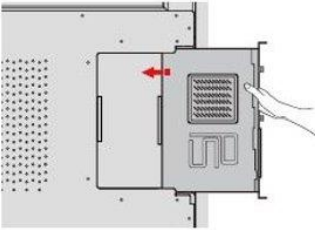

4. Secure the OPS module in position by screwing it onto the display input panel using the screws that were removed earlier.

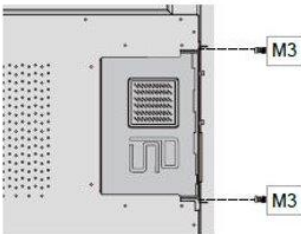

5. Ensure the installation is complete before turning on the power.

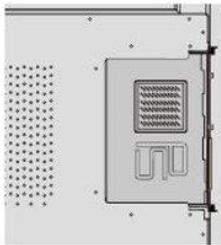

6. Turn on the display. When using an Avocor OPS PC you should see a green light on the side of the OPS, this will indicate that the OPS PC is switched on and operational.



When installing or de-installing an OPS PC, the display must be switched off. If the display is on when performing the installation or deinstallation of the OPS PC, this could cause damage to either the display or OPS PC invalidating the warranty for both.

⑤ Rear panel connectors



1

2

3

1	AV IN
2	VGA AUDIO IN
3	VGA IN

3. Product description

3.4 Connector

3.4.1 Connector of HDMI/Display port

- In order to transmit digital video and audio signals from an external device to the screen, connect the HDMI/Display Port cables as shown in the following illustration.

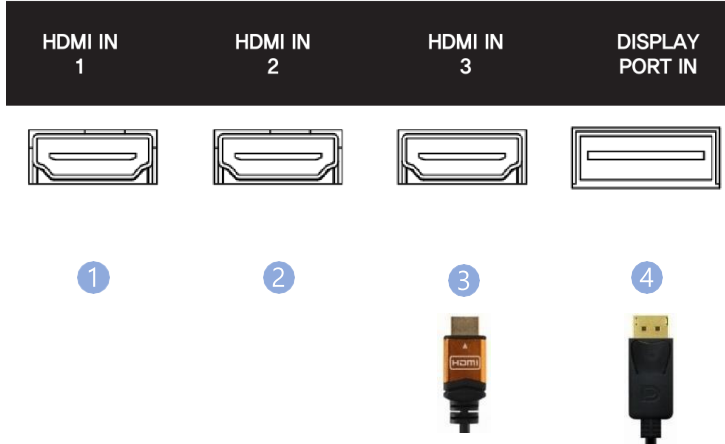

1	HDMI 1 input - PC / Laptop connect to the HDMI cable
2	HDMI 2 input - PC / Laptop connect to the HDMI cable
3	HDMI 3 input - PC / Laptop connect to the HDMI cable
4	Display port input - PC / Laptop connect to the Display port cable

3.4.2 OPS connection

- Do not connect USB for touch cable to the port. Touch cable is already connected by internal OPS docking board.

4. Remote controller



Key name	Description
	Power On / Off
	Shows the current external input
	Activates home screen
	Activates annotation Screen
	Touch On / Off
	TV Source select (not supported)
	OPS PC select
	Front HDMI→HDMI1→HDMI2→HDMI3
	Display port→TYPE C type port
	VGA→AV
	Go to previous media
	Start or pause media
	Stop media
	Go to the next media
	Display main OSD menu
	Select external input menu
	Built-in camera and microphone function adjustment menu (This only works while the camera is in motion).
	OSD Menu Exit and Back
	Select menu
	Adjust or select menu
	Volume down
	Mute
	Volume up
	Screen mode (Standard/Soft/Bright/User)
	Sound mode (Standard/Sport/User)
	Adjust screen brightness (3 levels)
	Freeze current display
	Run E-Share app
	Eye protection mode On / Off
	TV Channel search (not supported)
	Check the list of TV channels (not supported)
	Add and delete TV channels (not supported)

4.1 Battery replacement

- Insert the battery into proper polarities
- Battery model: Alkaline Battery 1.5V(AAA)

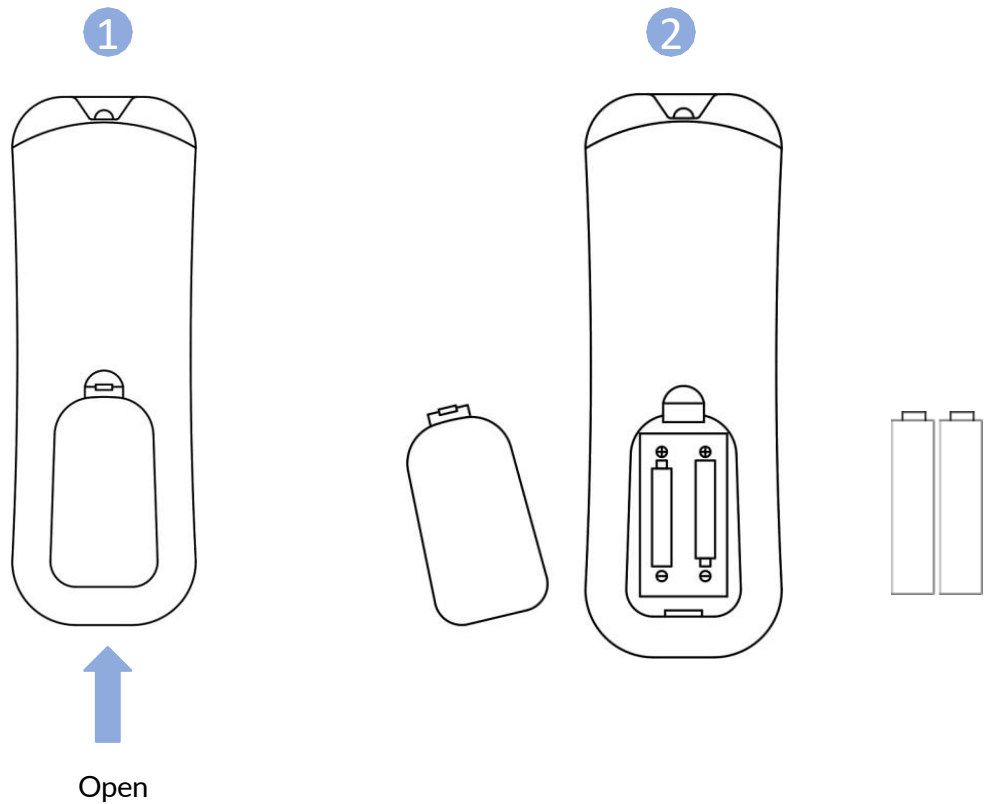

BATTERY PRECAUTIONS

These precautions should be followed when using batteries in this device:

- The batteries may last approximately one year depending on use. Replace batteries when the remote controller stops functioning.
- Use only the size and type of batteries specified (AAA).
- Be sure to follow the correct polarity when inserting the batteries (see image above). Reversed batteries may cause damage to the device.
- Do not use different types of batteries together (e.g. Alkaline, Carbon-zinc or Rechargeable) or old batteries with new ones.
- If the device is not to be used for a long time, remove the batteries to prevent damage or injury from possible battery leakage.
- Do not try to recharge batteries not intended to be recharged. It may cause damaged to remote controller. (Follow battery manufacturer's directions.)
- Do not use damaged batteries as they can become very hot and are dangerous.
- Never expose batteries (battery pack or batteries installed) to excessive heat such as sunshine, fire or the like.

5. System Settings

5.1 Network & internet



❖ Wireless networks (Wi-Fi)

The A-Series is equipped with a Wi-Fi MODULE, which supports Wi-Fi 5 and has a maximum UP and DOWN speed of 866 Mbps (2.4 GHz to 5 GHz band)

❖ Wired Network (Ethernet)

The A-Series has two LAN IN/OUT ethernet terminals that support only one network input and a maximum speed of 1000 Mbps.

1. One LAN terminal can be used as an INPUT for network connectivity, while the other LAN terminal can be connected to an external PC to receive network connection from the display.

(The connected external PC maximum network speed is 1000 Mbps).

2. This network connection will also feed into the OPS.

(The maximum network speed for the equipped OPS is 1000 Mbps.)

3. The front USB-C input can also share this network connection at a maximum of 100Mbps.

5.1.1 Internet

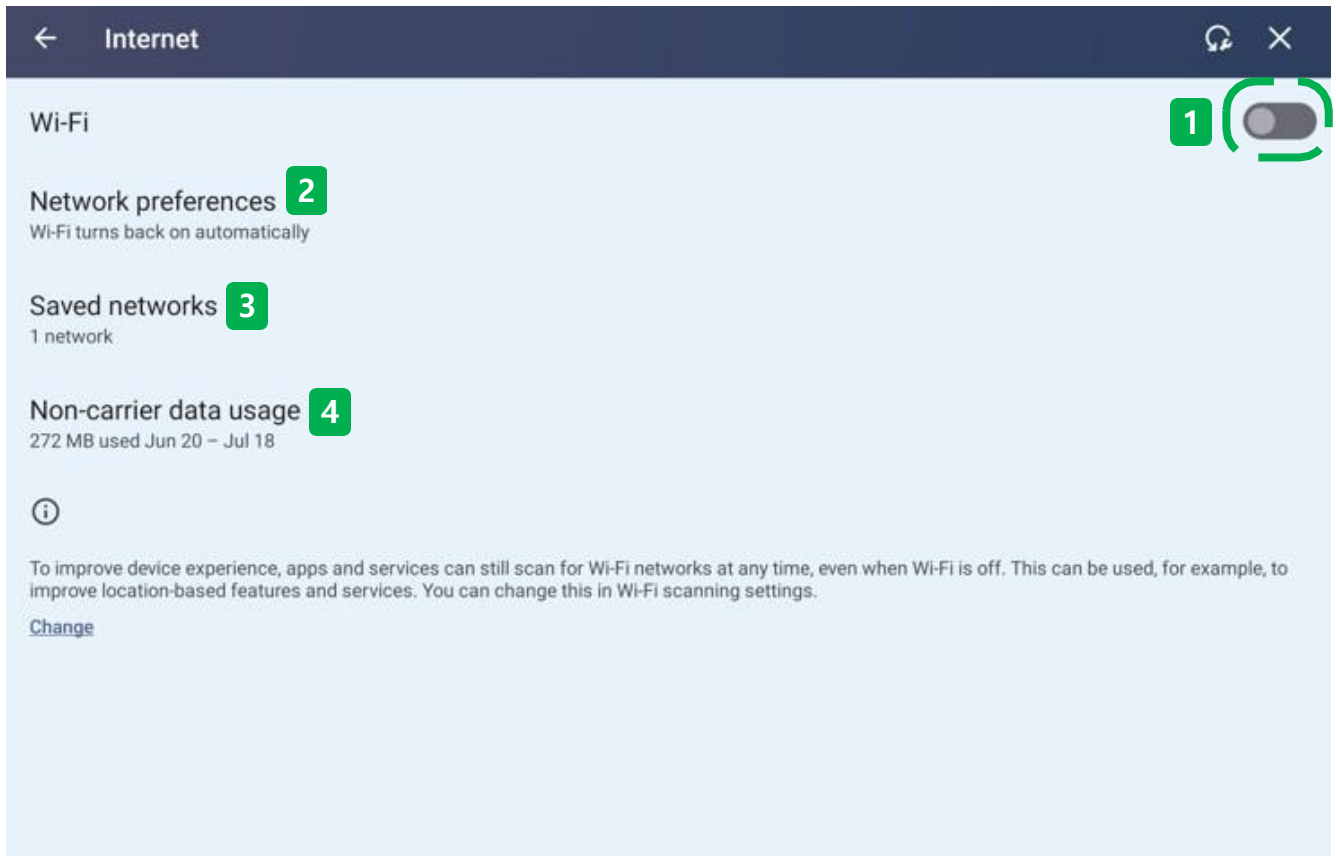

① Wi-Fi (wireless network)

- Press the Wi-Fi ON/OFF button to detect nearby Wi-Fi signals. (2.4GHz ~ 5GHz)



Network preferences

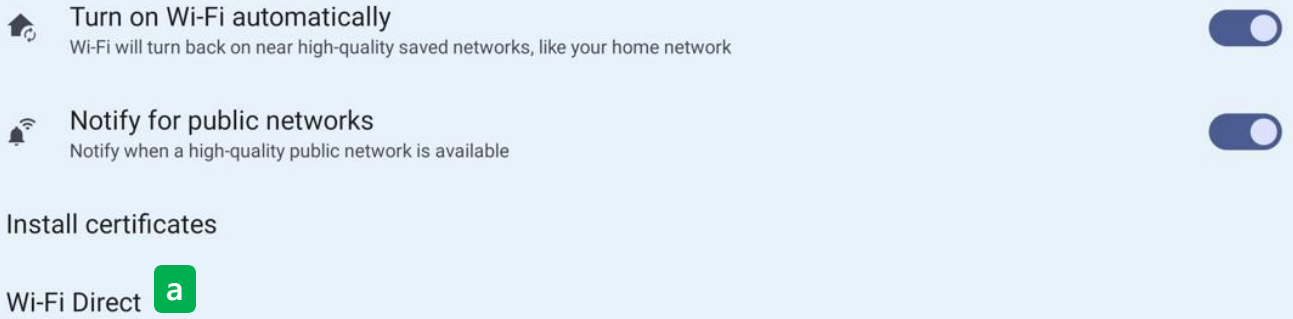

The screenshot shows the 'Network preferences' settings page. It includes three main sections: 'Turn on Wi-Fi automatically' with a toggle switch turned on and a sub-note 'Wi-Fi will turn back on near high-quality saved networks, like your home network'; 'Notify for public networks' with a toggle switch turned on and a sub-note 'Notify when a high-quality public network is available'; and 'Install certificates'. At the bottom, there is a 'Wi-Fi Direct' option with a green square icon containing a white letter 'a'.

② Network preferences

- **Turn on Wi-Fi automatically:** Wi-Fi is reenabled when a saved network is in range of the device.
- **Notify for public networks:** A notification window appears when a high-quality public network is available.
- **Install certificates:** If the network users are connecting to requires a certificate, install the required certificate directly.
- **Wi-Fi Direct:** Share files with devices with Wi-Fi Direct without a separate cable or network connection.



The screenshot shows the 'Wi-Fi Direct' interface. At the top, there is a dark blue header with a back arrow, the text 'Wi-Fi Direct', and a close button. Below the header, the device name 'Android_aaco' is displayed. Underneath, there is a section titled 'Peer devices'. This section lists three available devices: 'DE133-PC', 'DE142-PC', and 'DIRECT-B7-SA SL-T1670FW Series'. Each device name is followed by the word 'Available' and a Wi-Fi signal icon on the right side.

a. Wi-Fi Direct

- **Android_aaco :** The device name of IFPD that can be found on the external device. (It varies from device and IP address.)
- **peer devices :** It shows a list of peripherals that can be connected to IFPD.

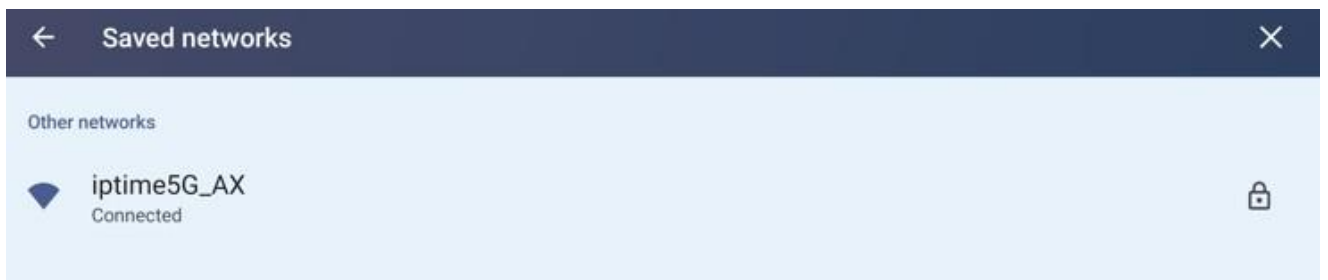

③ Saved networks

- This is a list of Wi-Fi networks that the display was connected to.
- Once connected, Wi-Fi is stored in that entry and automatically connects without entering a password when reconnecting.

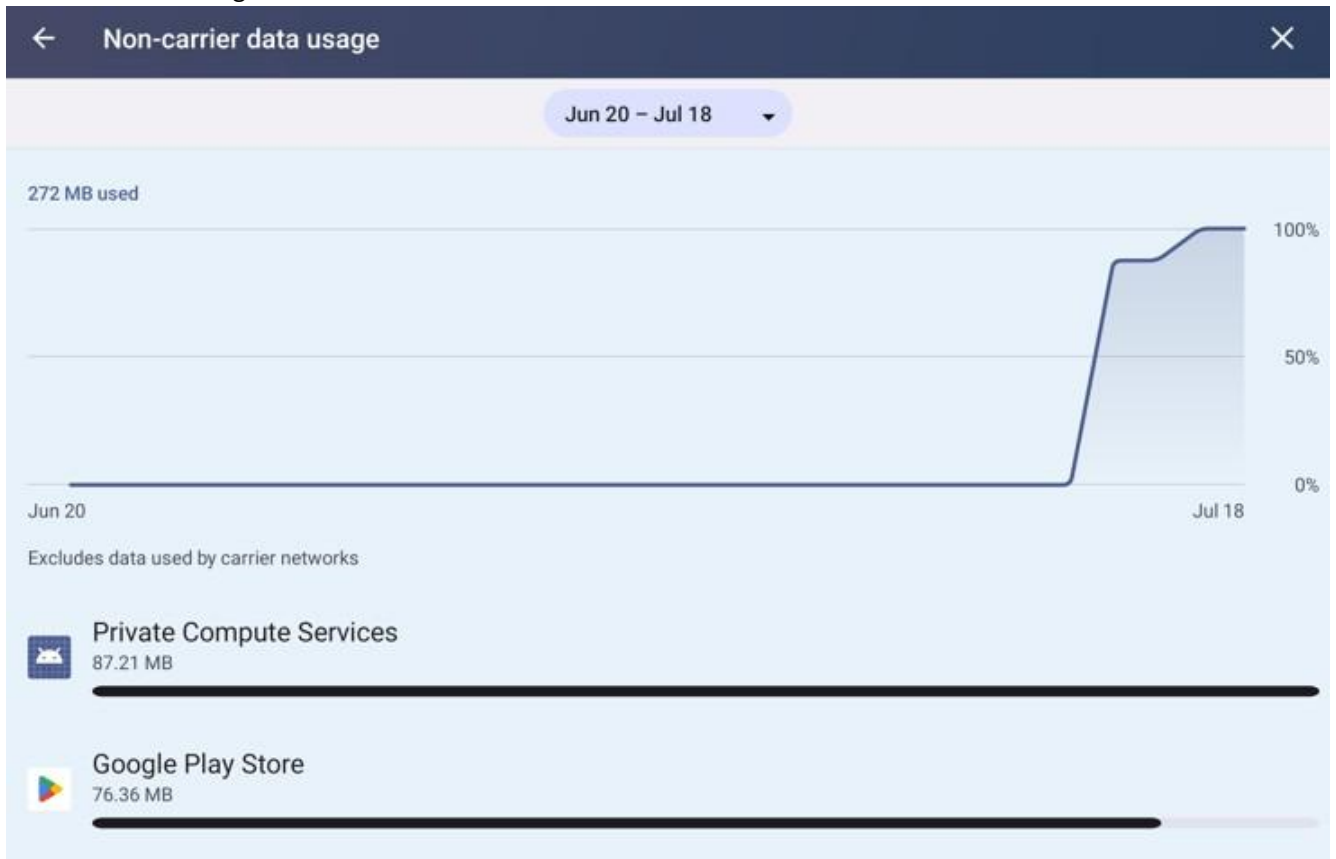

④ Non-carrier data usage

- Users can check the network data usage for each date.
- The data used through the mobile carrier network is excluded.

5.1.2 Wired network

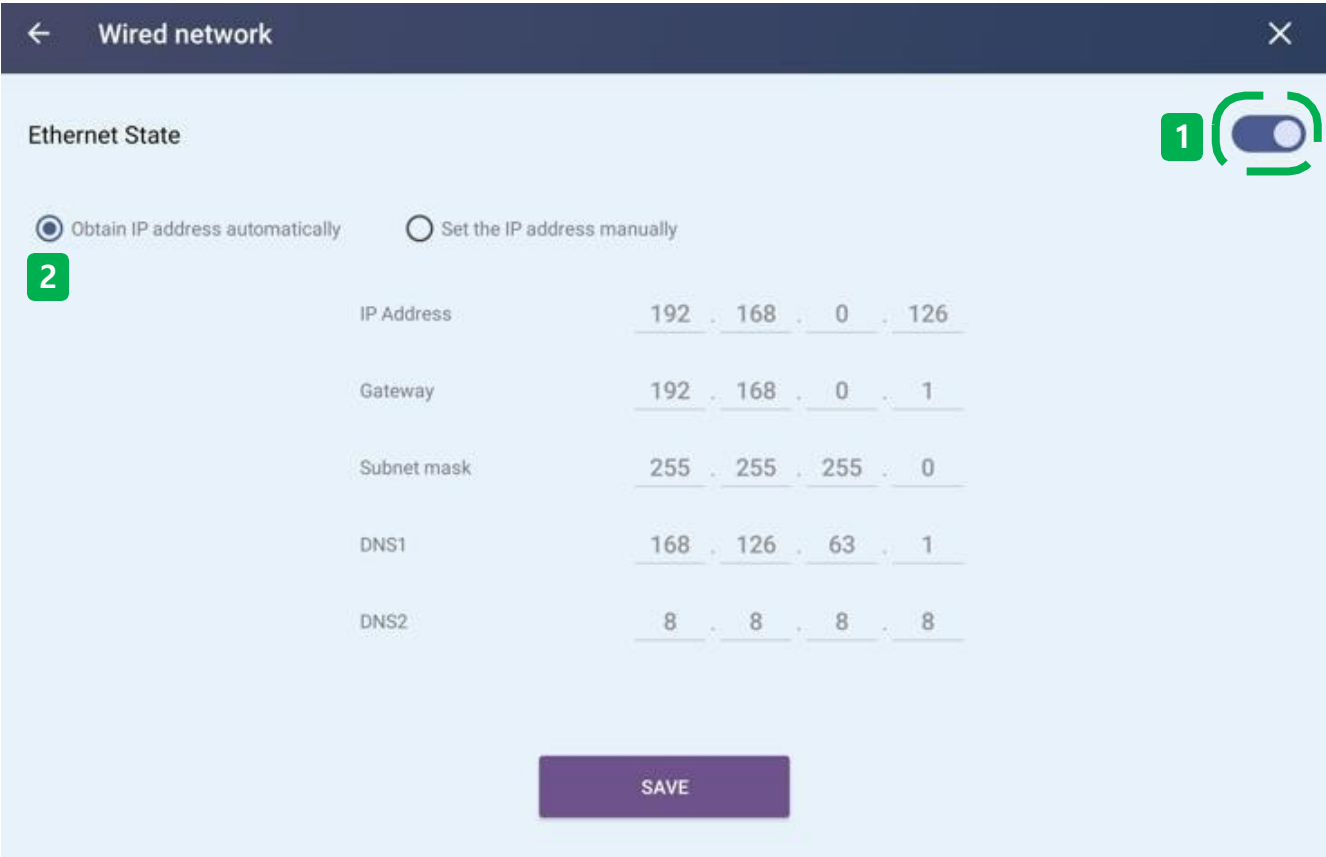

① Ethernet state

- Toggle on/off the Ethernet connection.
- The Wi-Fi connection is automatically broken when connecting Ethernet.

② Obtain IP address automatically

- The IP address and other communication parameters are automatically assigned to IFPD connected to the network.
- After setup, Users can connect to the Internet using DHCP on the wired network.

5.1.2 Wired network

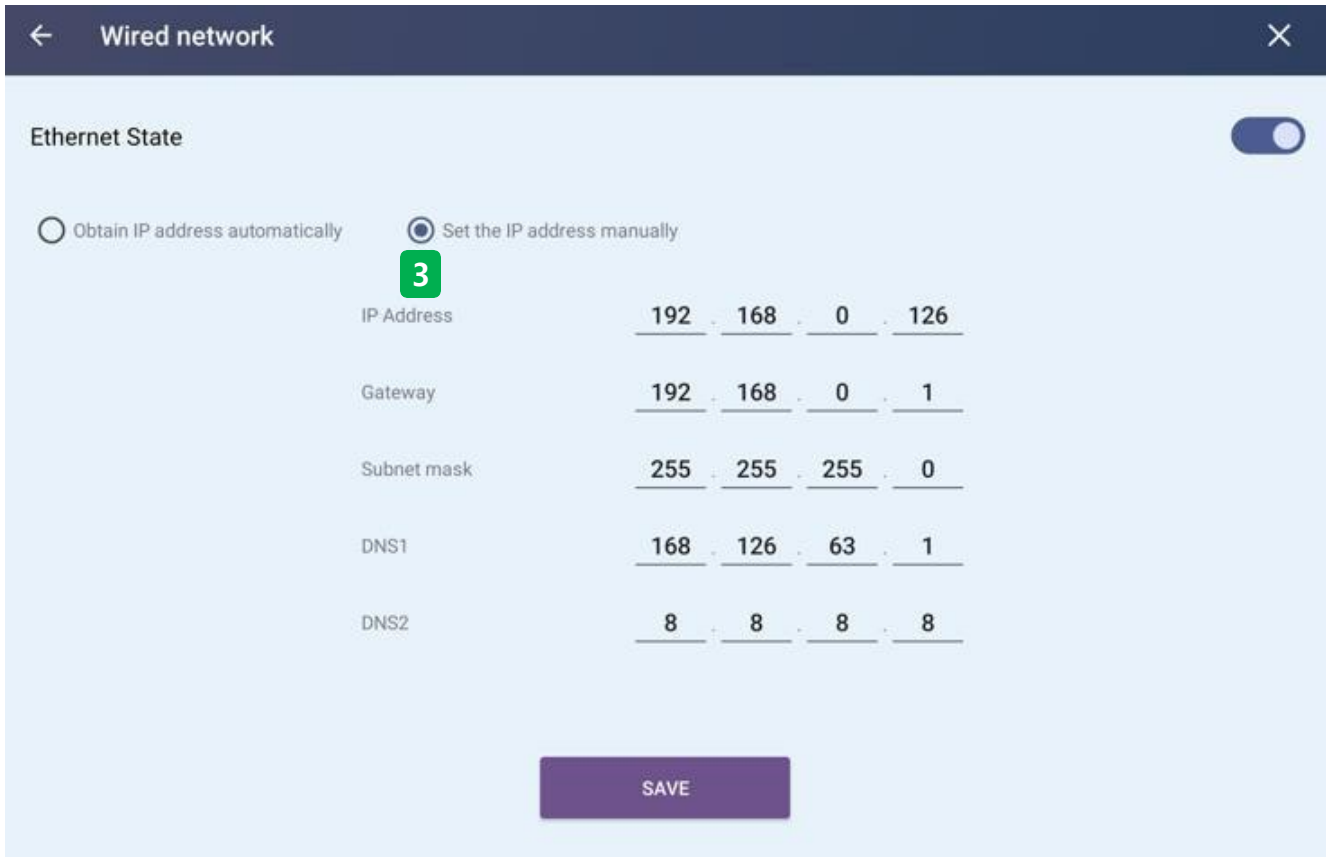

③ Set the IP address manually

- Manually enter the IP address, Gateway, Subnet mask, DNS address directly.
- After setting up, Users can connect to the Internet using the fixed IP of the wired network.

5.1.3 Hotspot & tethering

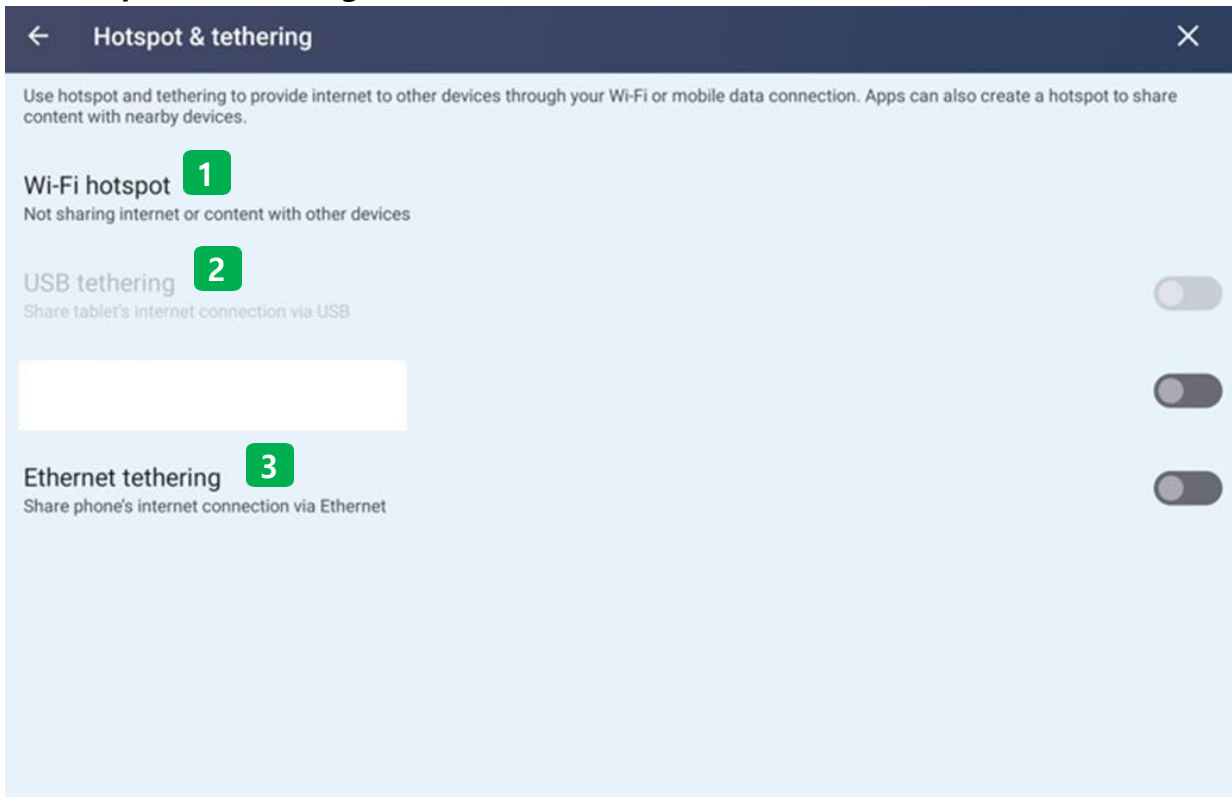

❖ Hotspot & tethering

- Hotspots and tethering allow other devices to use the Internet via my Wi-Fi or mobile data connection. Apps can also create hotspots to share content with peripherals.

① Wi-Fi hotspot

- Select it to enter the detailed hotspot settings.

② USB tethering

- Connect USB to share IFPD's Internet connection.
- The function is activated when connected to a mobile phone by USB (the feature is not currently supported).

③ Ethernet tethering

- Share users phone's internet connection over Ethernet.
- It can work when connecting IFPD and mobile phones via Ethernet.

5.1.3 Hotspot & tethering

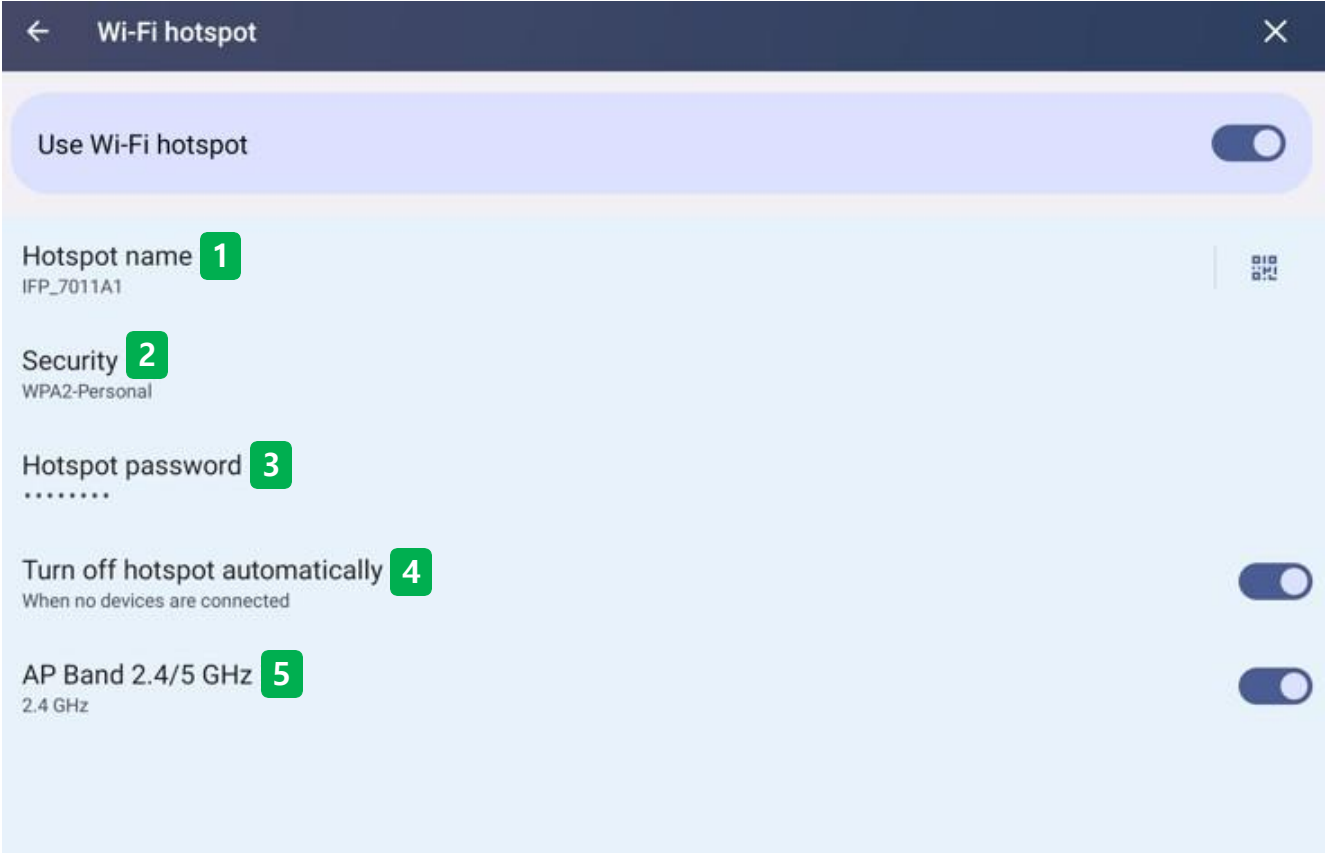

① Hotspot name



- Users can change the name of the hotspot when you select the Hotspot name section.

② Security



- When selecting the Security part, users can change the security protocol of HotSpot.
- WPA2-Personal : Encrypt the Wi-Fi hotspot to enter users password when connecting hotspot.
- None : Set the Wi-Fi Hotspot to connect without password input.

5.1.3 Hotspot & tethering

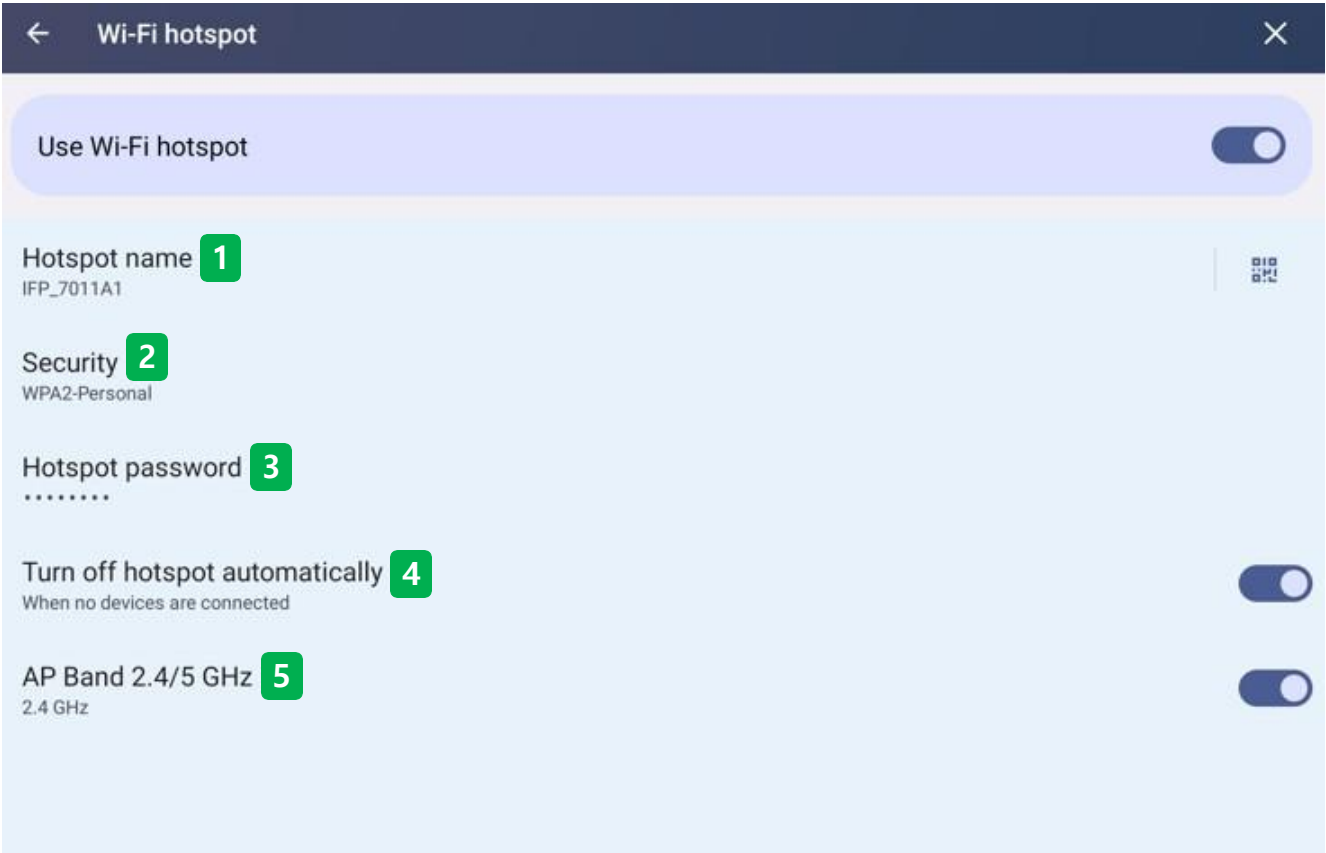

③ Hotspot password



- Set the Hotspot password. (Initial Password: 12345678)

④ Turn off hotspot automatically

- If there is no device connected to Hotspot on the display, it automatically stops using Hotspot.

⑤ AP band 2.4/5 GHz

- Switch the Hotspot band on the display through the ON/OFF button.
- ON : 2.4GHz
- OFF : 5GHz

5.1.4 Data saver

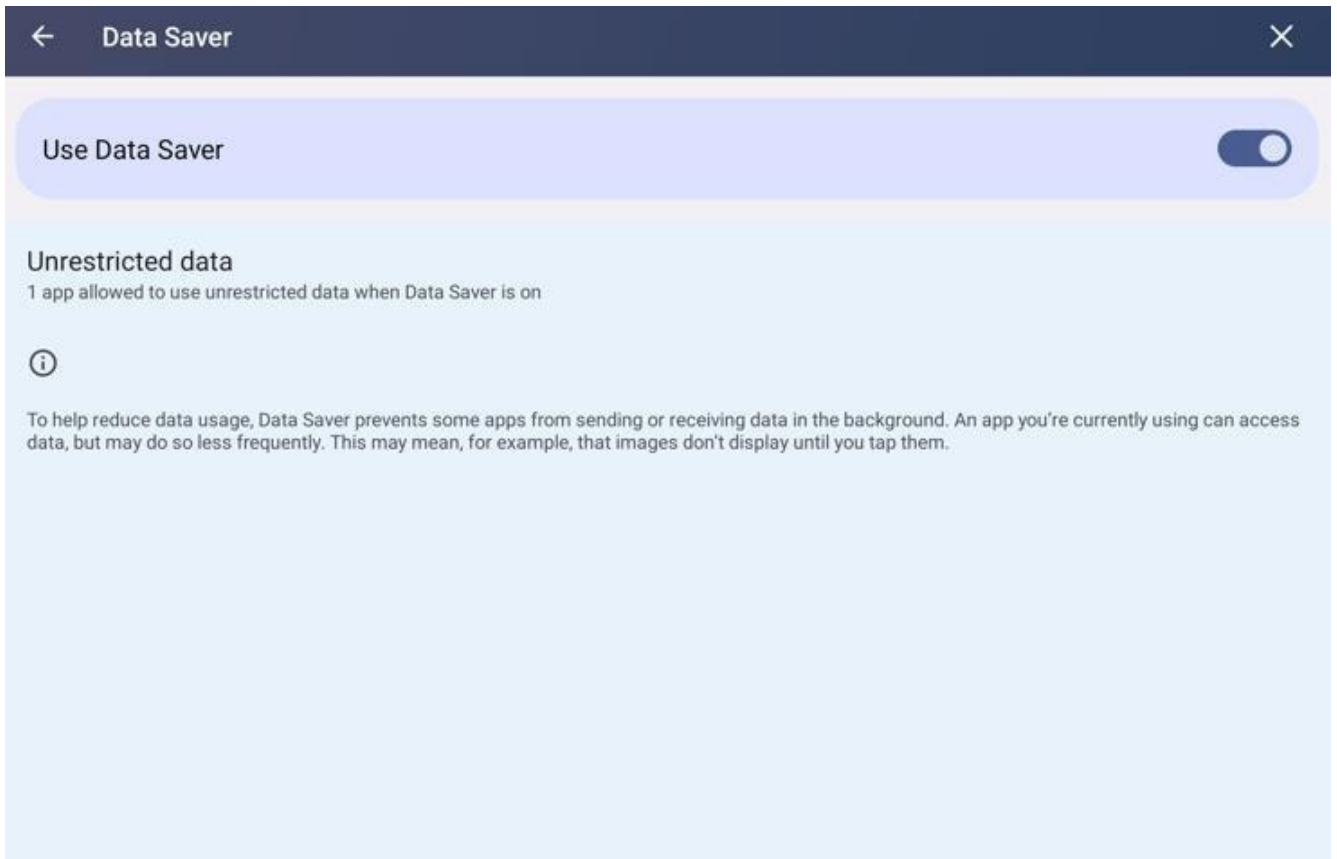

❖ Use data saver

- Turn on or off the data saving mode through the ON/OFF button.

❖ Unrestricted data

- Allows one app to use unlimited data when Data Saving mode is on.

① Functional supplementary description

- To reduce data usage, Data Saver mode prevents some apps from sending or receiving data in the background. Users can access data in the app currently in use, but the frequency is reduced. For example, the image is not displayed before tapping the image.

5.1.5 VPN

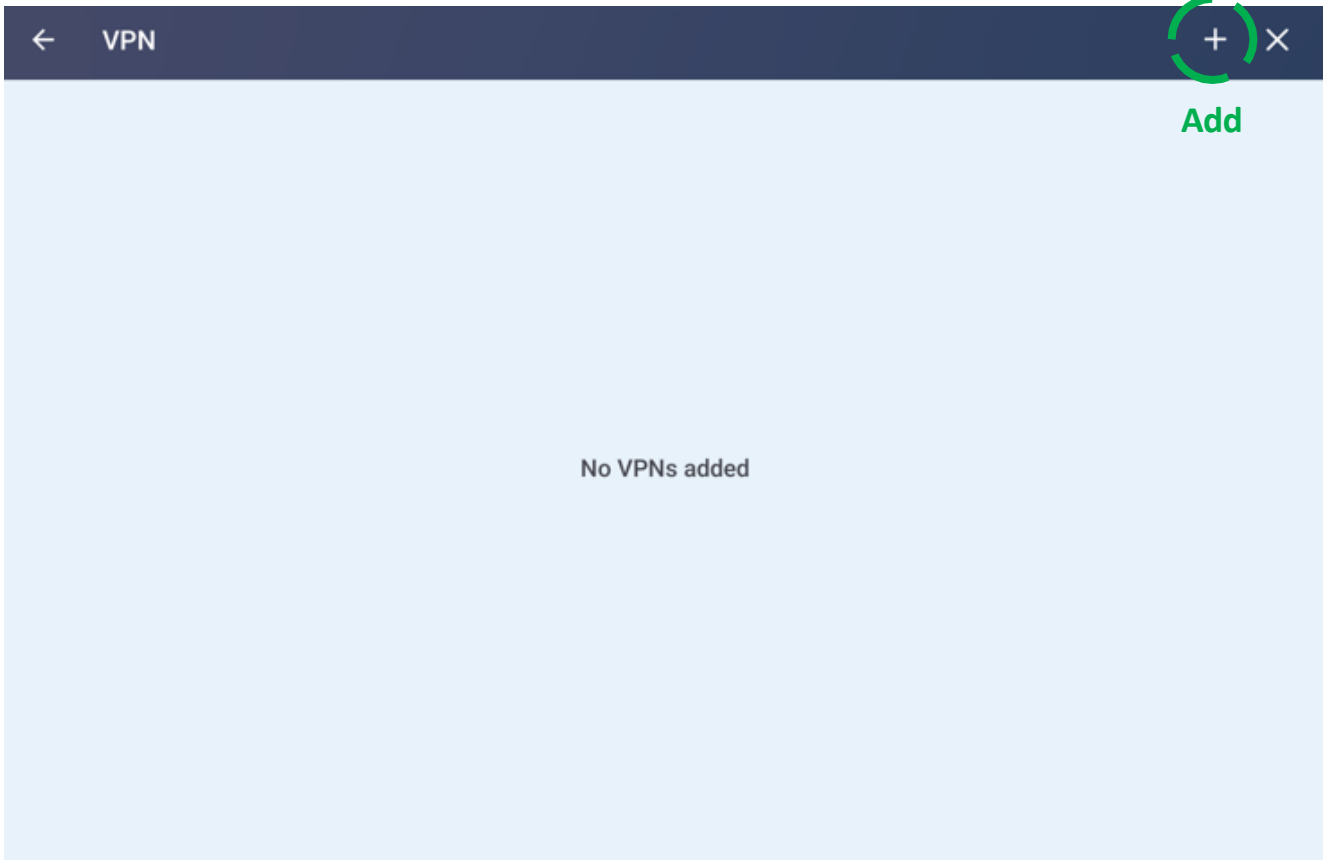

❖ VPN

- Users can add VPN settings by clicking the "+" icon.

Edit VPN profile

Name

Type

IKEv2/IPSec MSCHAPv2

Server address

IPSec identifier

(not used)

IPSec CA certificate

(don't verify server)

IPSec server certificate

(received from server)

Proxy

None

Username

Password

Always-on VPN

The information entered doesn't support always-on VPN

CANCEL SAVE

Name

- Set the name. (Random name designation)

Type

- Select the connection type.
- IKEv2/IPSec MSCHAPv2
- IKEv2/IPSec PSK or RSA (2 types)

Server address

- The IP address or full server hostname.

IPSec identifier

- Leave that part blank.

IPSec CA certificate

- Used only for user certificate connections and EAP connections.

IPSec server certificate

- Used only for user certificate connections.

Proxy

- Enter the proxy address of the router to connect.

Username

- Specify the ID to use when connecting VPN.

Password

- Specify the password to use when connecting

5.1.6 Private DNS



❖ Private DNS

- The ability to specify a user-specified DNS server without using the ISP default server.
- Network security and usage environments may be improved than when using the default DNS server provided by a carrier.

Private DNS provider hostname

Enter hostname of DNS provider

CANCEL SAVE

❖ Android private DNS hostname setting example

Google DNS (dns.google)

- Google Public DNS protects users from many types of phishing attacks.

AdGuard DNS (dns.adgaurd.com)

- Free DNS to block ads, trackers, and phishing sites

OpenDNS (dns.opendns.com)

- Cloud-based DNS that provides Malware protection and content filtering

NextDNS (dns.nextdns.io)

- Cloud-based DNS with features such as blocking ads, anti-malware, and child protection.

5.2 Connected device

❖ Connect with external devices

- IFPD can be connected to an external device via USB, Wi-Fi, etc.

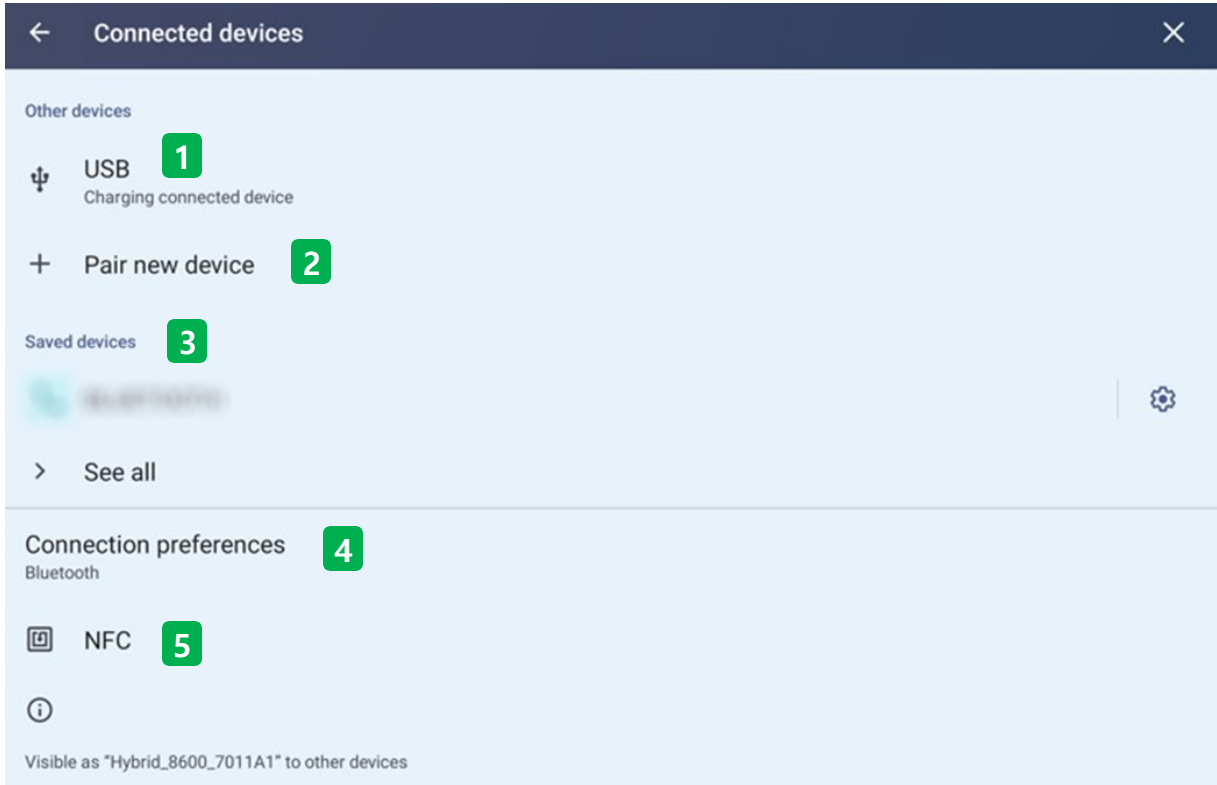

① USB

- Set the use and options of the external device connected by IFPD and the USB.

② Pair new device

- Search and add devices around IFPD.

③ Saved devices

- Displays a saved list of IFPD and connections.

④ Connection preferences

- Set preferences for connected devices. (Cast, Printing, Nearby Share, etc.)

⑤ NFC

- Register the NFC card on IFPD.

5.2.1 USB Preferences

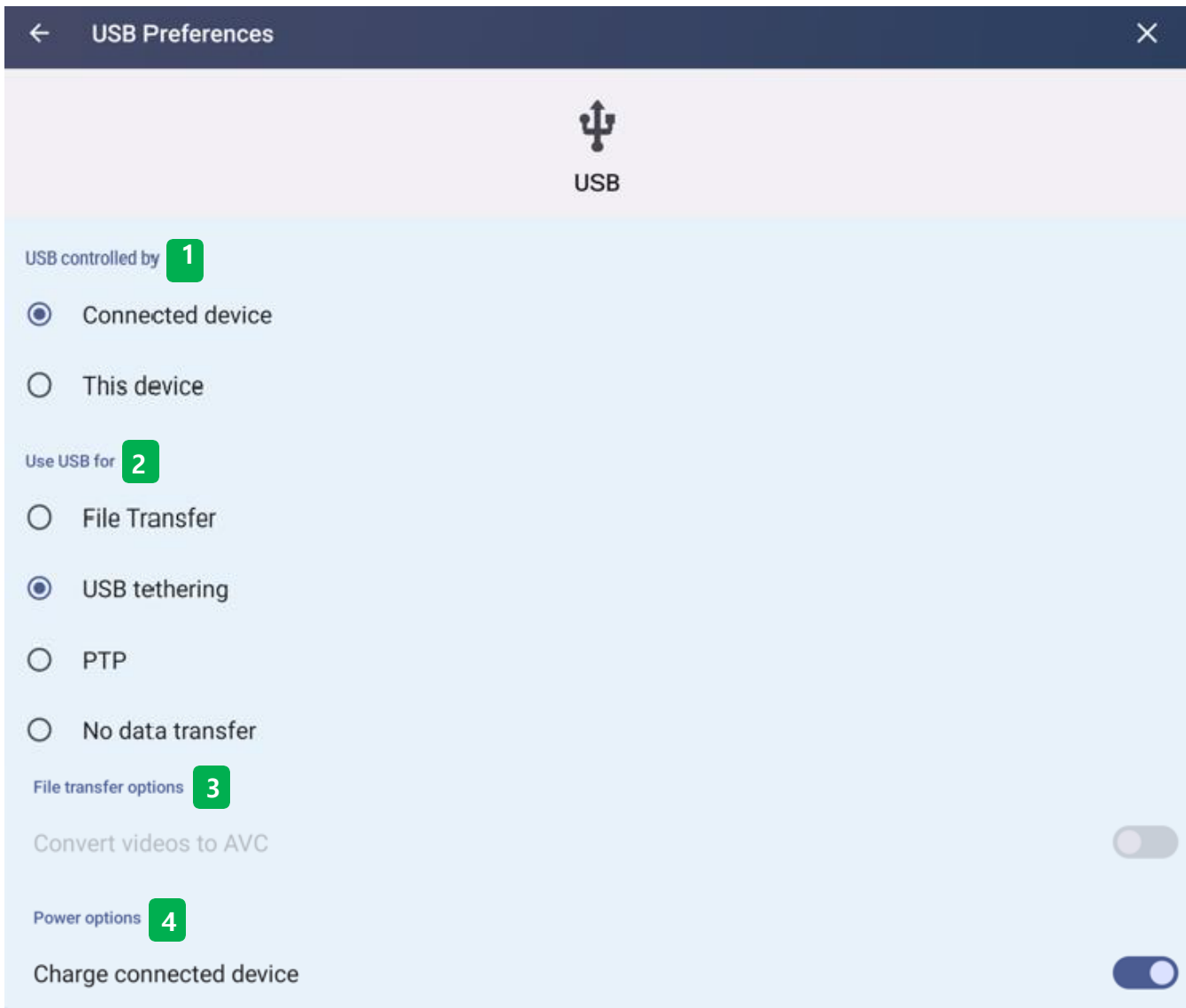

① **USB controlled by**

- Users can switch USB control permissions with the USB device connected to IFPD.

② **Use USB for**

- Select the USB usage of the device connected to IFPD.
- The list that can be selected is not to transmit file transfer, USB tethering, PTP, and no data transmission.

③ **File transfer options**

- When Users transfer a video file, Users can convert it to an AVC file.

④ **Power options**

- Users can turn the charging on and off for IFPD and USB-connected devices.

5.2.2 Pair new device

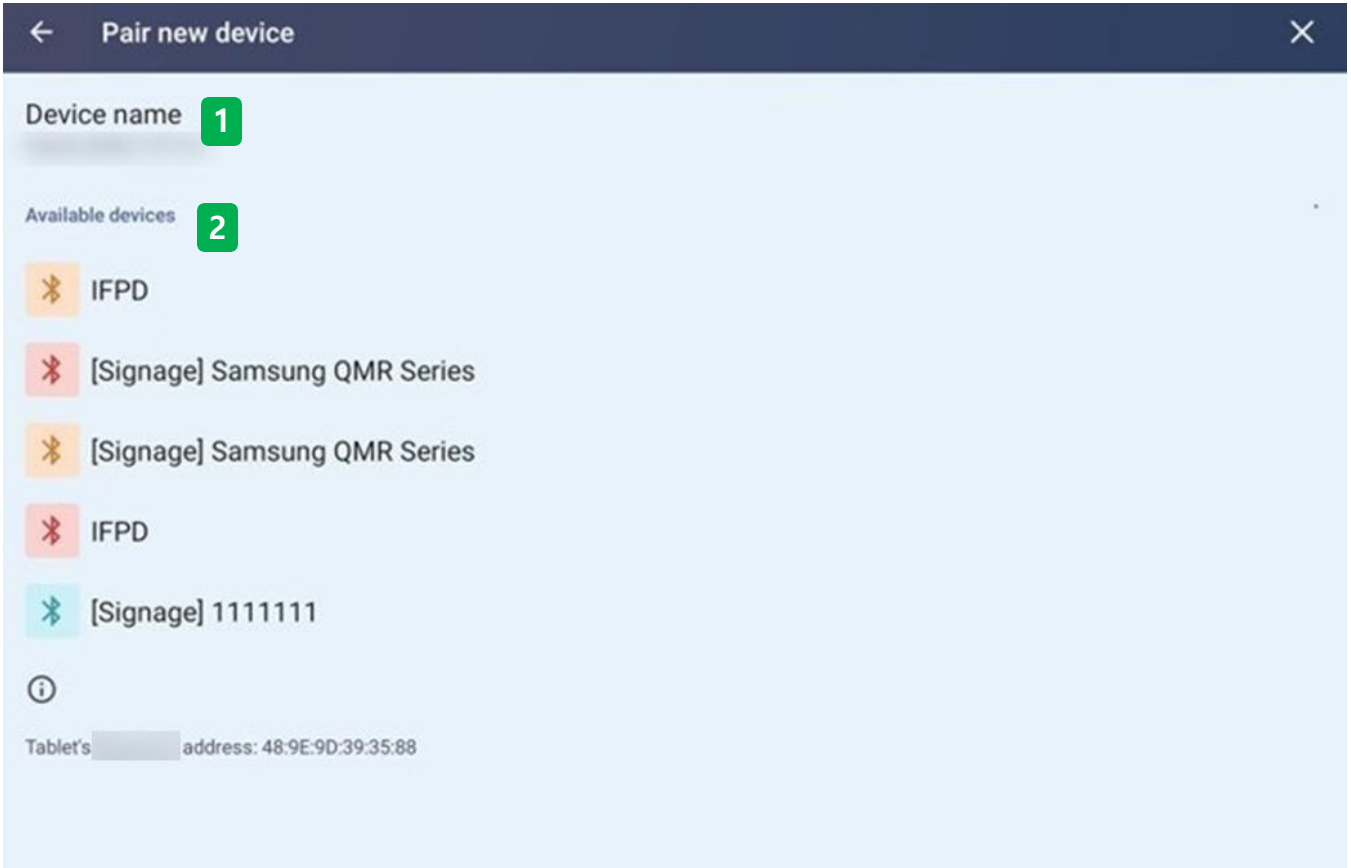

① **Device name**

- Display the current name on the display, and Users can change the name by selecting this section.

② **Available devices**

- Automatically search for nearby devices that can be connected from the display.
- Users can pair by selecting the device they want to connect.

③ **Address**

- Shows the specific address of the product.

5.2.3 Saved devices

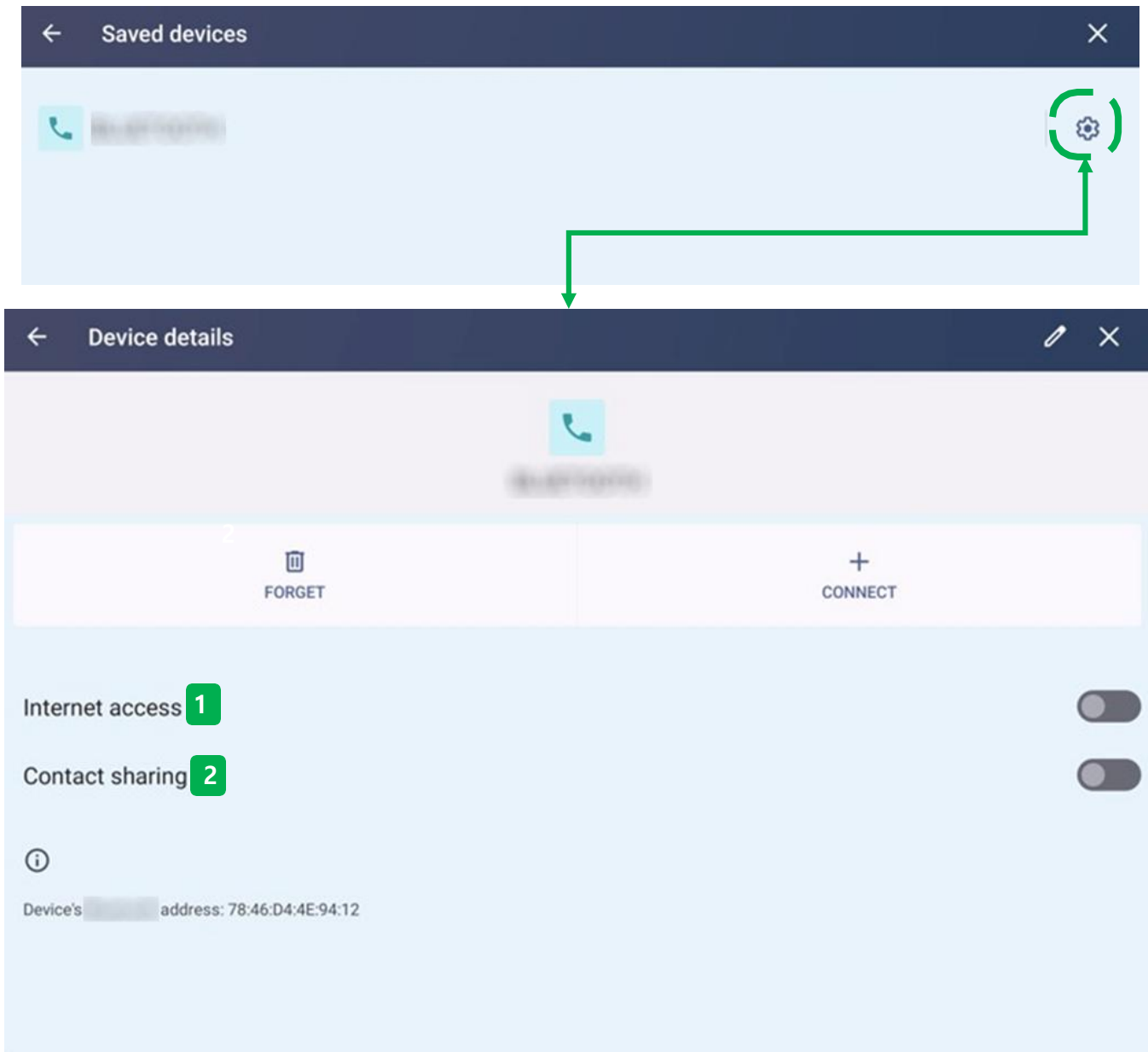

① **Internet access**

- Tethering allows Users to share users network.

② **Contact sharing**

- Share the user's phone's contacts and save them on the display.

① **Address**

- Shows the specific address of the connected device.

5.2.4 Connection preferences

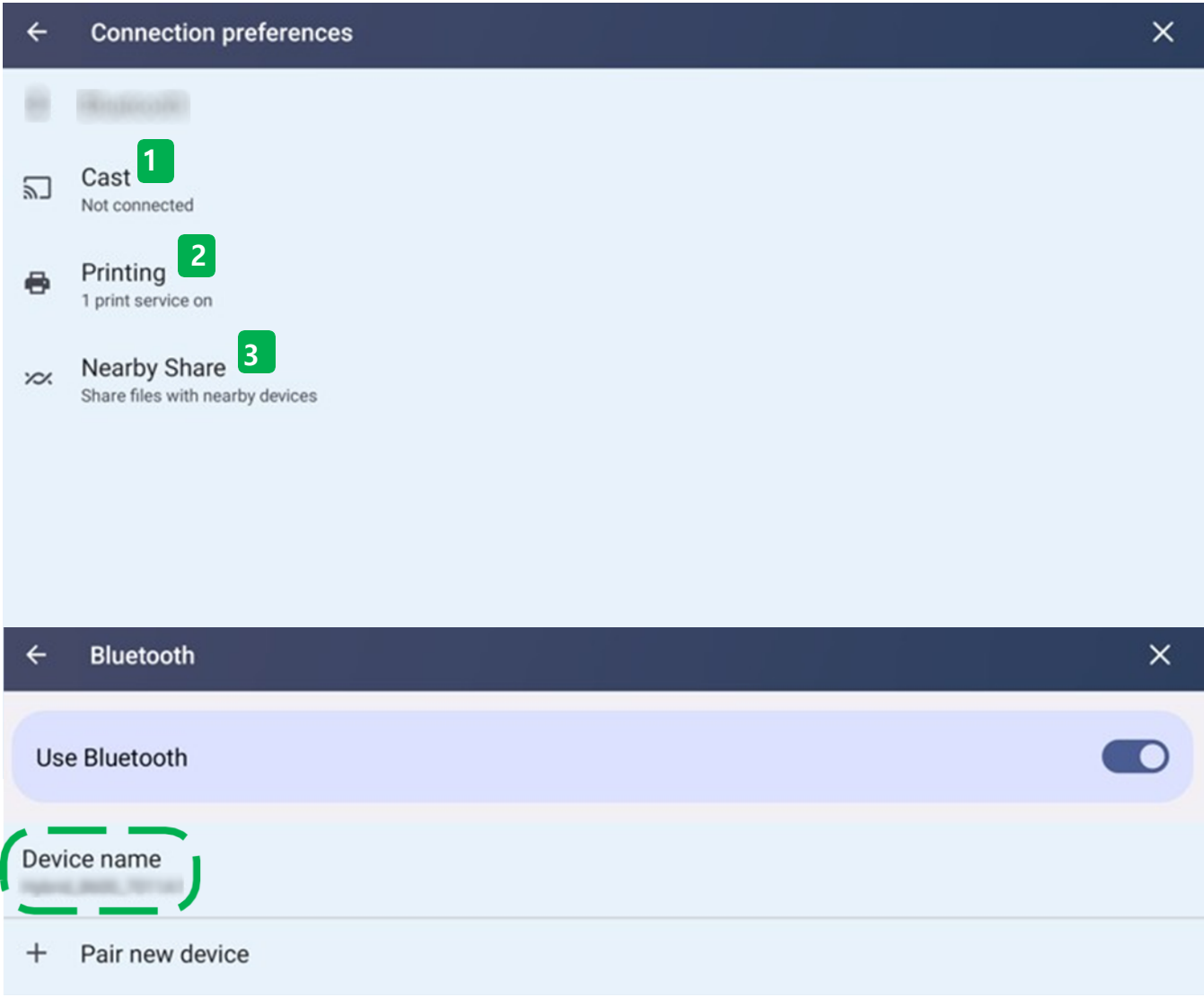

① Cast

- Shows a list of mobile phones connected by the display and Mirroring.
The display and mobile phones must be connected to the same Wi-Fi.

5.2.4 Connection preferences

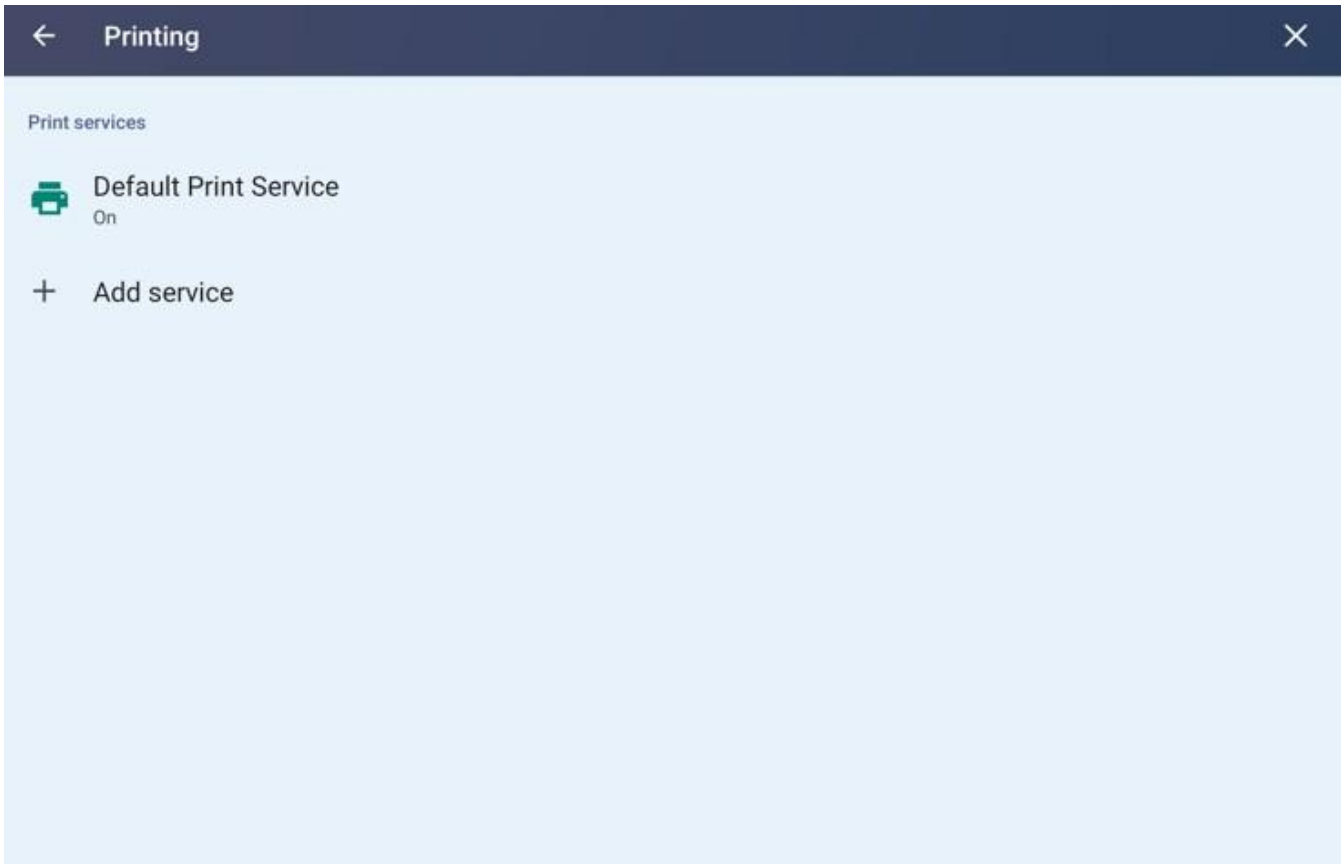

② Printing

- Users can connect a Printer device to IFPD and use it.
- Refer to each printer manufacturer's connection description for details on how to connect the printers. (Ex: network connection, installation of dedicated apps through Google Play Store, etc.)

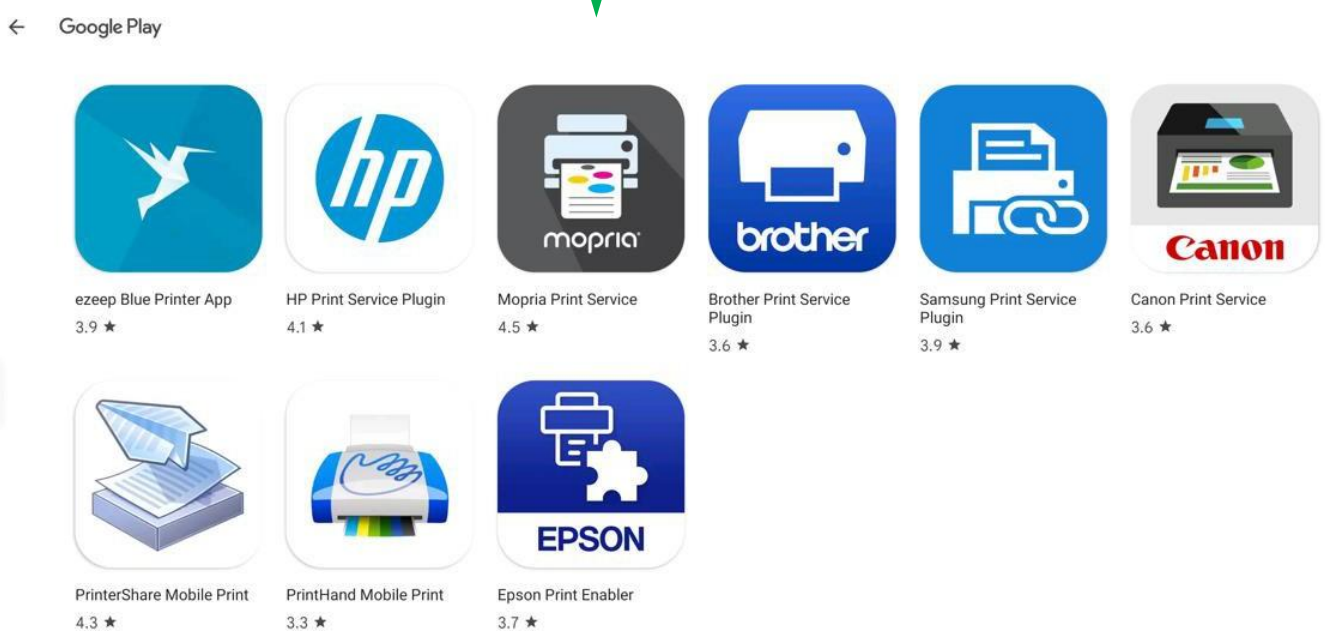

5.2.4 Connection preferences

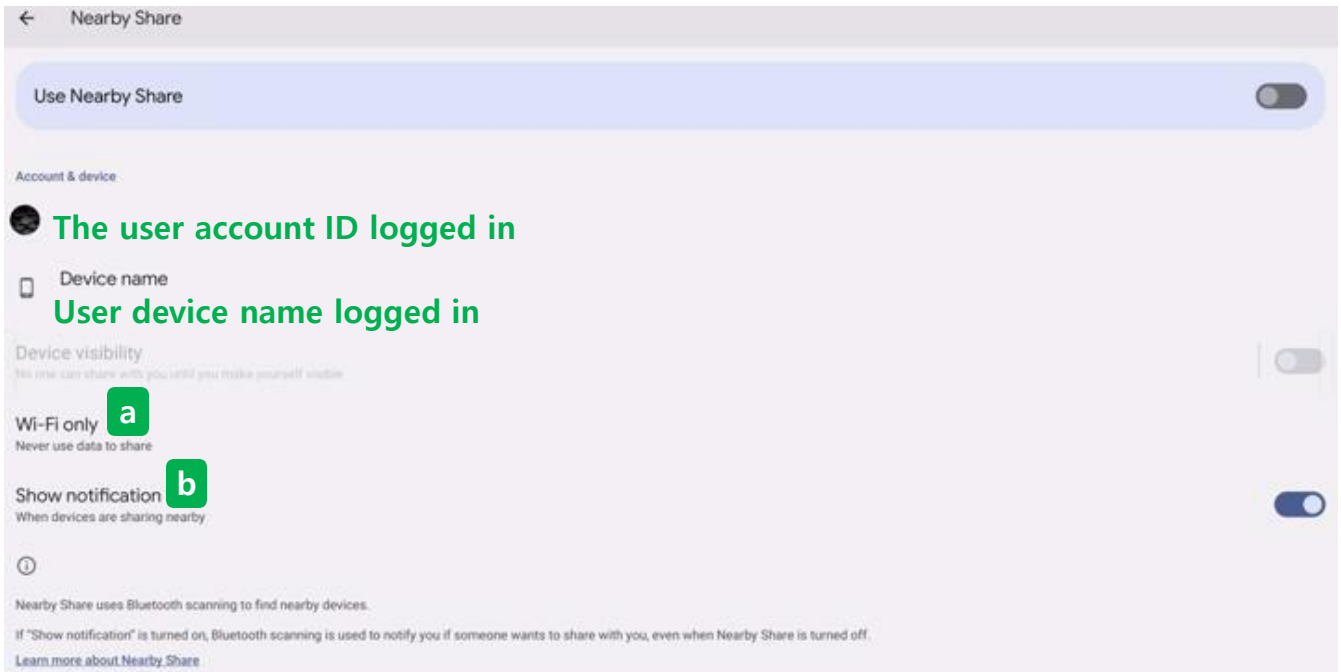

③ Nearby share

- It is a function of shares files such as photos, videos/documents, etc. as a large-capacity file transmission function and direct information on the nearby device.

① Enable file sharing only when Wi-Fi is connected.

② The notification window is displayed after sharing or sharing is completed.

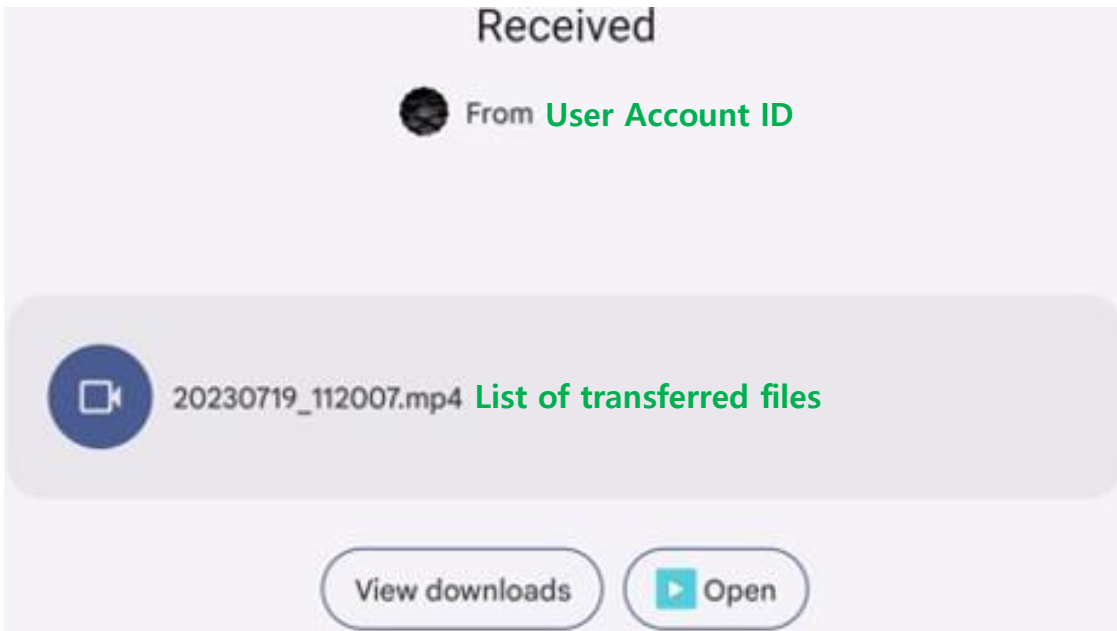

5.2.5 NFC

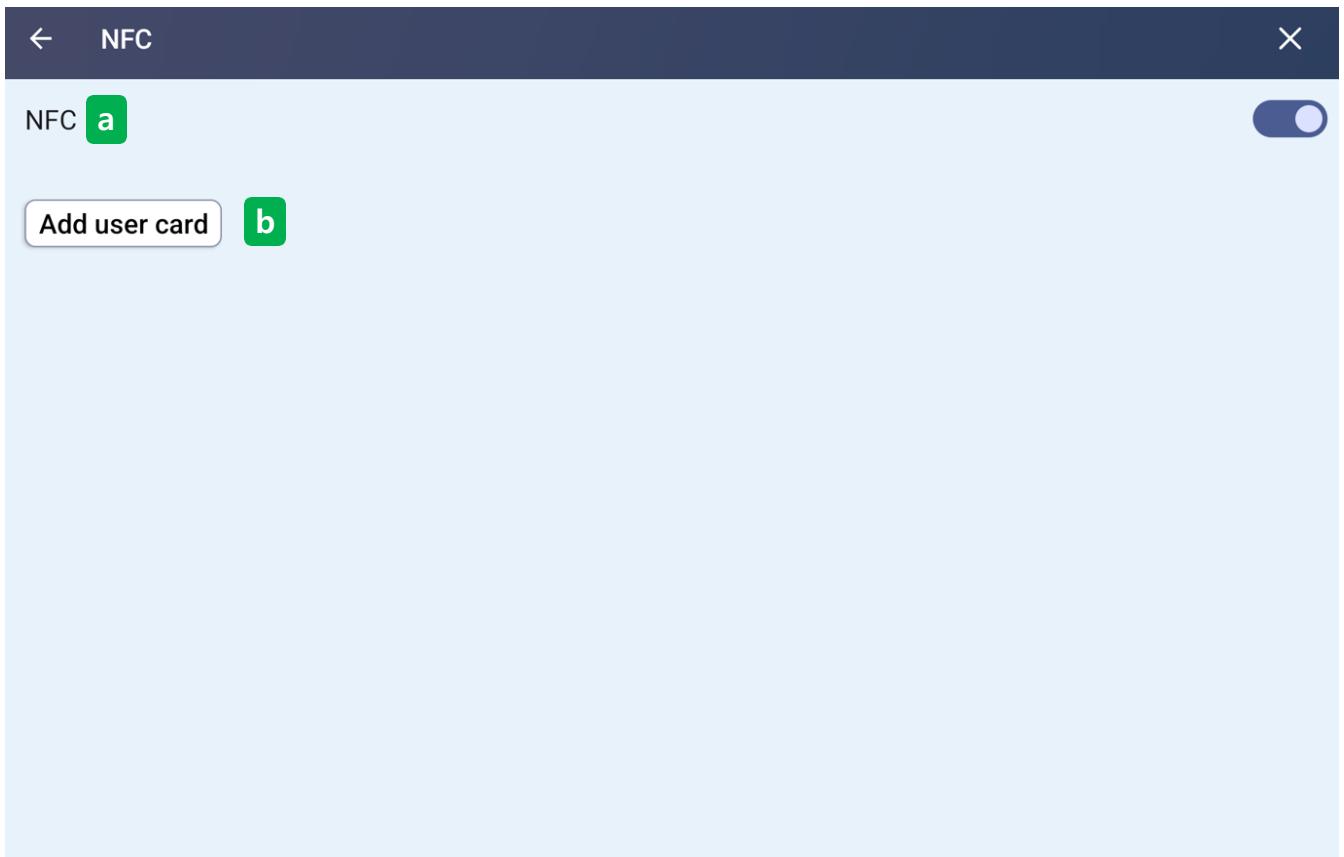

④ NFC

- Users can turn on the power by adding an NFC card to the display.
- When the NFC function is turned on, the power on the display can only be turned on through a registered NFC card.
(The method of turning off the product does not change. Power buttons, remote controls, and shutdown functions can be turned off via the NFC card.)

- ① Switch to enable or disable the NFC feature.
- ② Add a user-specific card in addition to the issued NFC card.

5.3 Advanced features

← Advanced Features ×

Automatic sleep 1

If there is no operation with the set time, the device automatically sleeps and IFPD shuts down.

15min 30min **45min** 60min

Boot channel 2

OPS boot 3

Network wakeup 4

Channel permission 5

Spotlight shape 6

Round Rectangle Oval

Auto Boot 7

Auto Shutdown 8

DICOM 9

Power Saver 10

RS232 ID 11
00

Network Control Port 12
59595

❖ Advanced features

- Control the power and external input-related functions of the display.

① Automatic sleep

- When there is no source signal or operation within the specified time, the device will automatically sleep and shut down.

Automatic sleep

When there is no source signal, there is no operation within the specified time. The device automatically sleeps, and Windows shuts down

15min 30min **45min** 60min

② Boot channel

- Select the screen that first enters when the display is turned on.

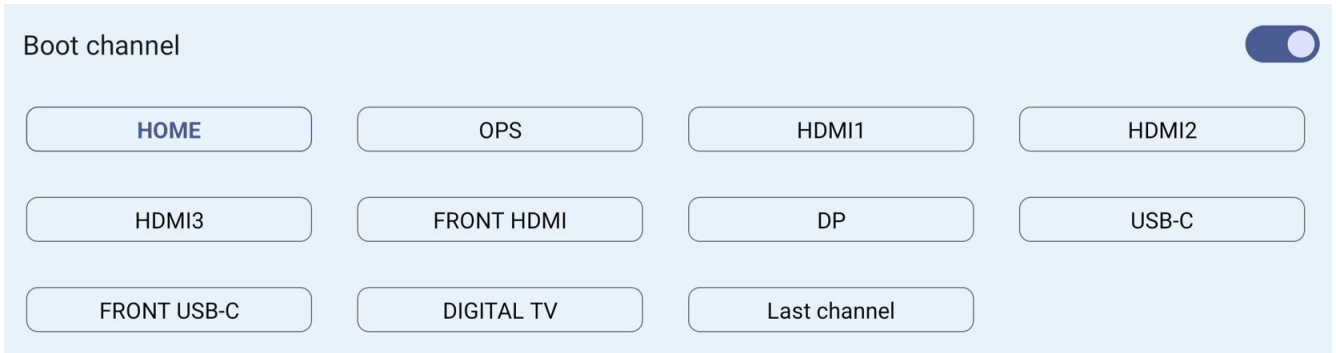

③ OPS boot

- Control the power of the OPS.
- OPS source only : When moving to the OPS screen, the OPS is turned on automatically.
- Any source : The OPS is automatically turned on when the display is turned on.



④ Network wakeup (Wake On Lan)

- By connecting a router to the electronic blackboard, Users can control the power of IFPD through other devices on the same network.
- For detailed connection instructions, please refer to each router manufacturer's product description.

⑤ Channel permission password

- Set the screen to switch only after entering the password Users set when switching external screen signals.

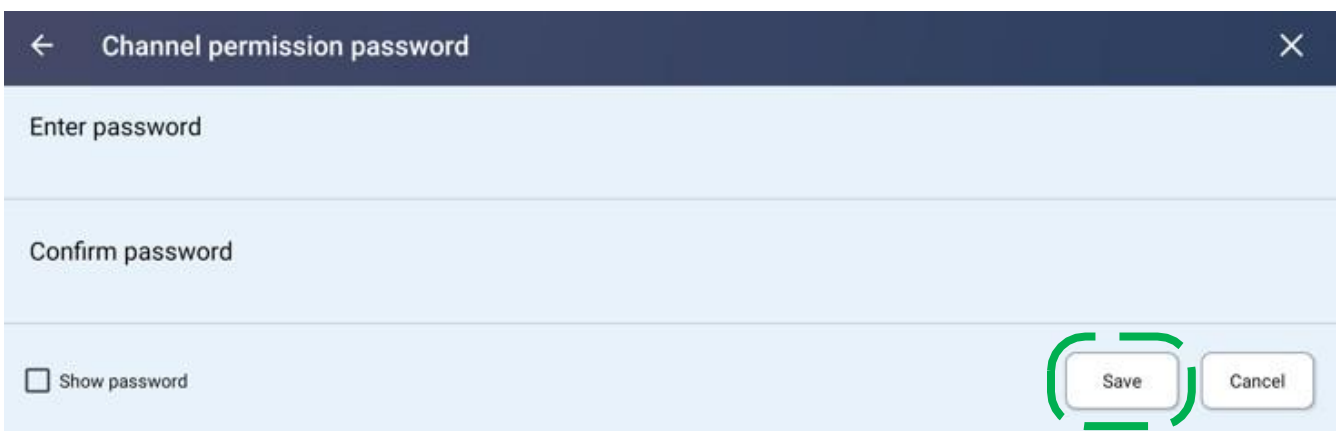

Save after setting password

5.3 Advanced features

⑥ Spotlight shape

- When switching external screen signals, set the screen to be switched only by entering the set password.



⑦ Auto boot

- The product automatically turns on at the set time.

⑧ Auto Shutdown

- The product automatically shuts down at the set time.

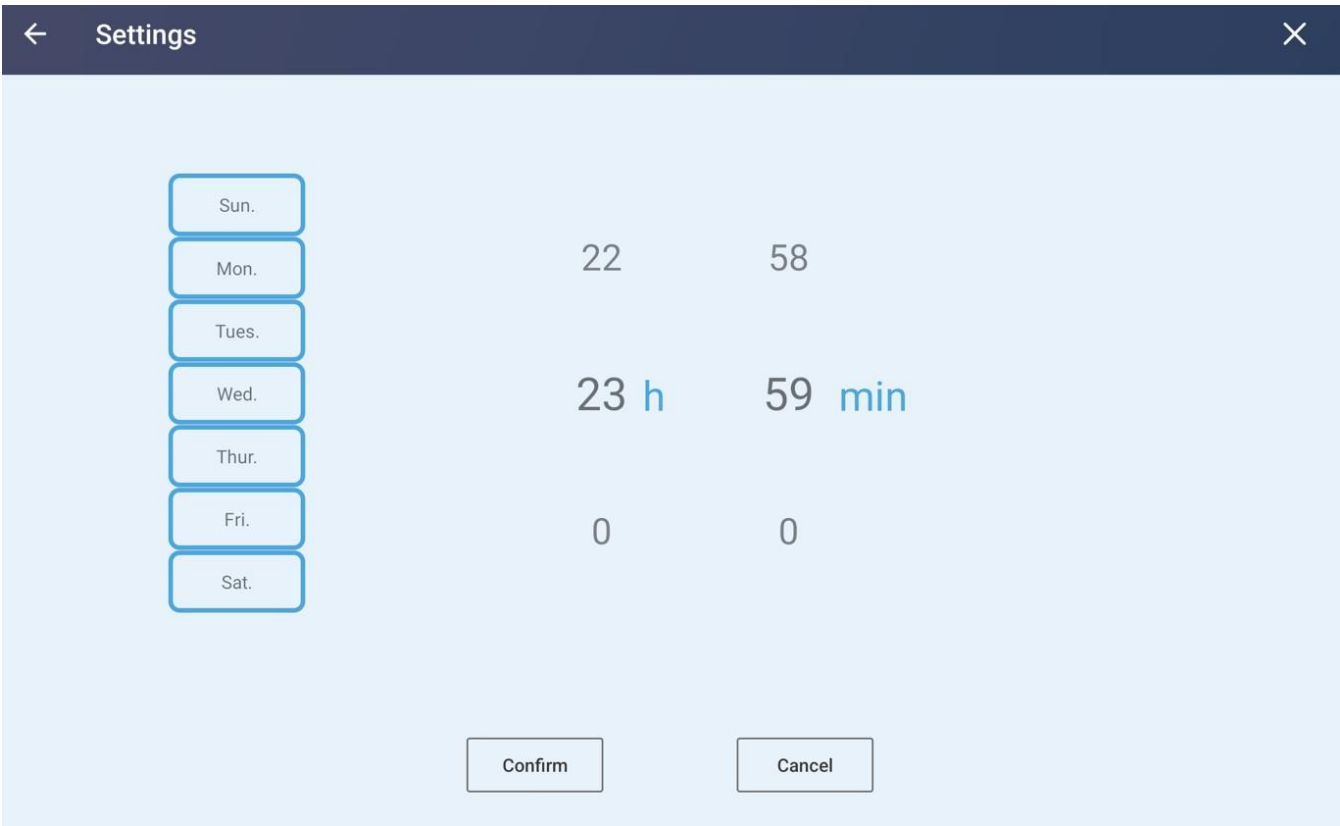

⑨ DICOM

- Turn DICOM mode off and on.

5.3 Advanced features

⑩ Power Saver

- You can use power saving features by setting the time to turn off the backlight and turn off the system.
- The time can be set from 1 to 90 minutes.

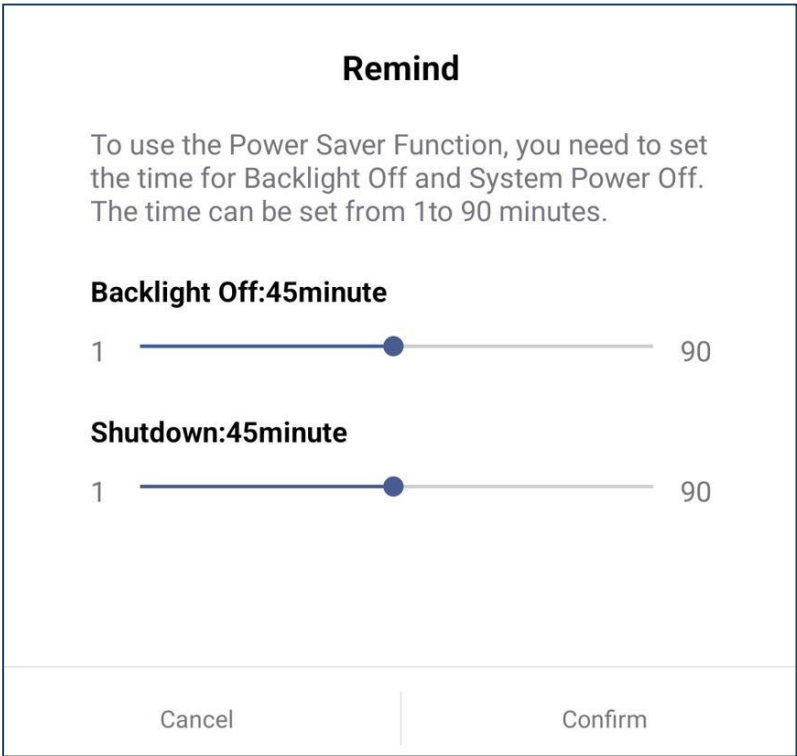

⑪ RS232ID

- RS232 ID can be set.



⑫ Network Control Port

- You can set up a network control port.



5.4 Apps

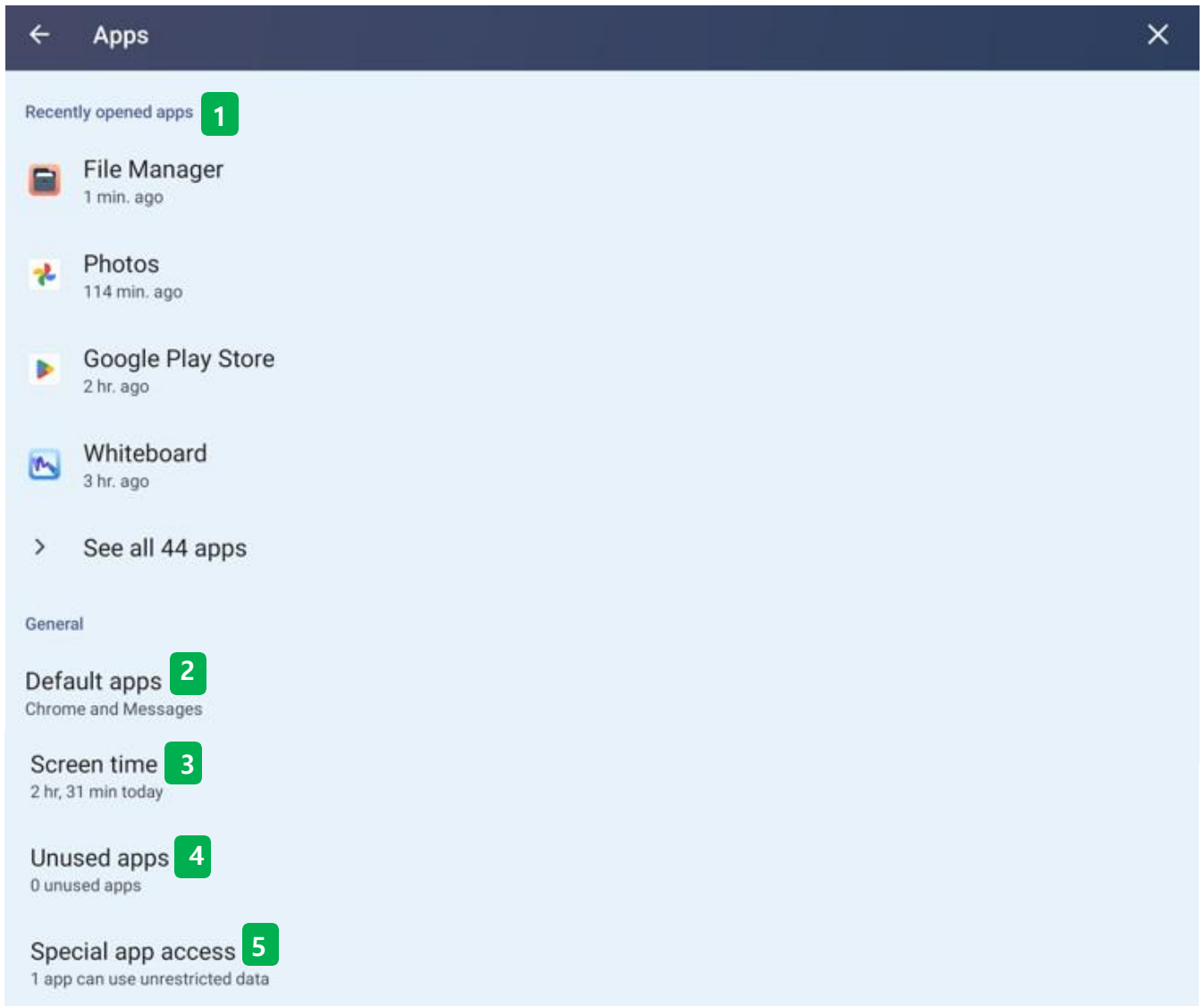

❖ App

- In the App section, Users can set the information, usage time, cache settings, and permission settings of all installed apps on the display.

① Recently opened apps

- Shows recently open App items and allows Users to view all App items installed on the display.
- When selecting the APP icon, Users can check the data such as notifications, permissions, storage capacity and cache, and data usage of each app..

② Default apps

- It shows the default App entry on the display. (the default App cannot be deleted).

5.4 Apps

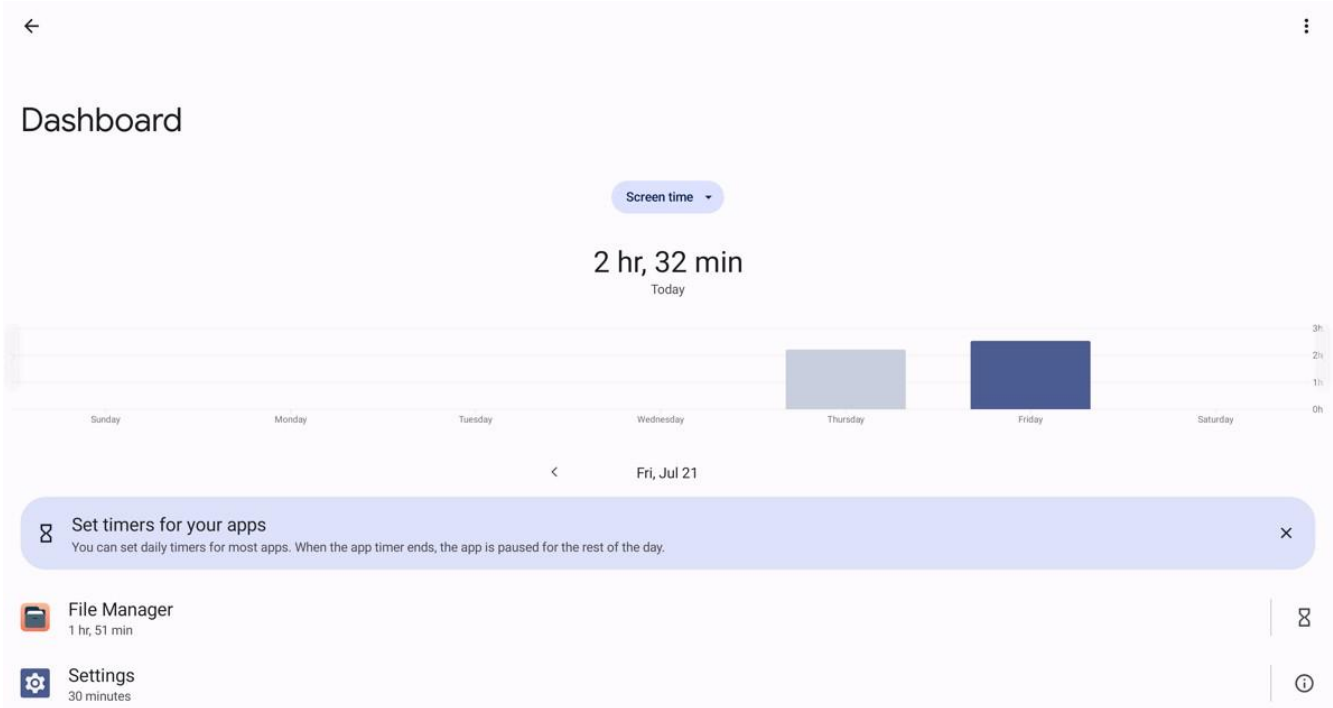

③ Screen time

- It shows Users a list of apps have used in the past week, and how many hours have spent with each app.

④ Unused apps

- It shows a list of apps that users haven't used in a long time.

- Device & app notifications
- Picture-in-picture
- Premium SMS access
- Unrestricted data
- Install unknown apps
- Alarms & reminders
- Usage access
- VR helper services
- Wi-Fi control
- Turn screen on

⑤ Special app access

- Users can set the app's permissions in each item, including device and app notifications, PIP mode, premium SMS connection, unlimited data, unknown app installation, alarms and reminders, VR helper service, Wi-Fi control, and screen on.

5.5 Notifications

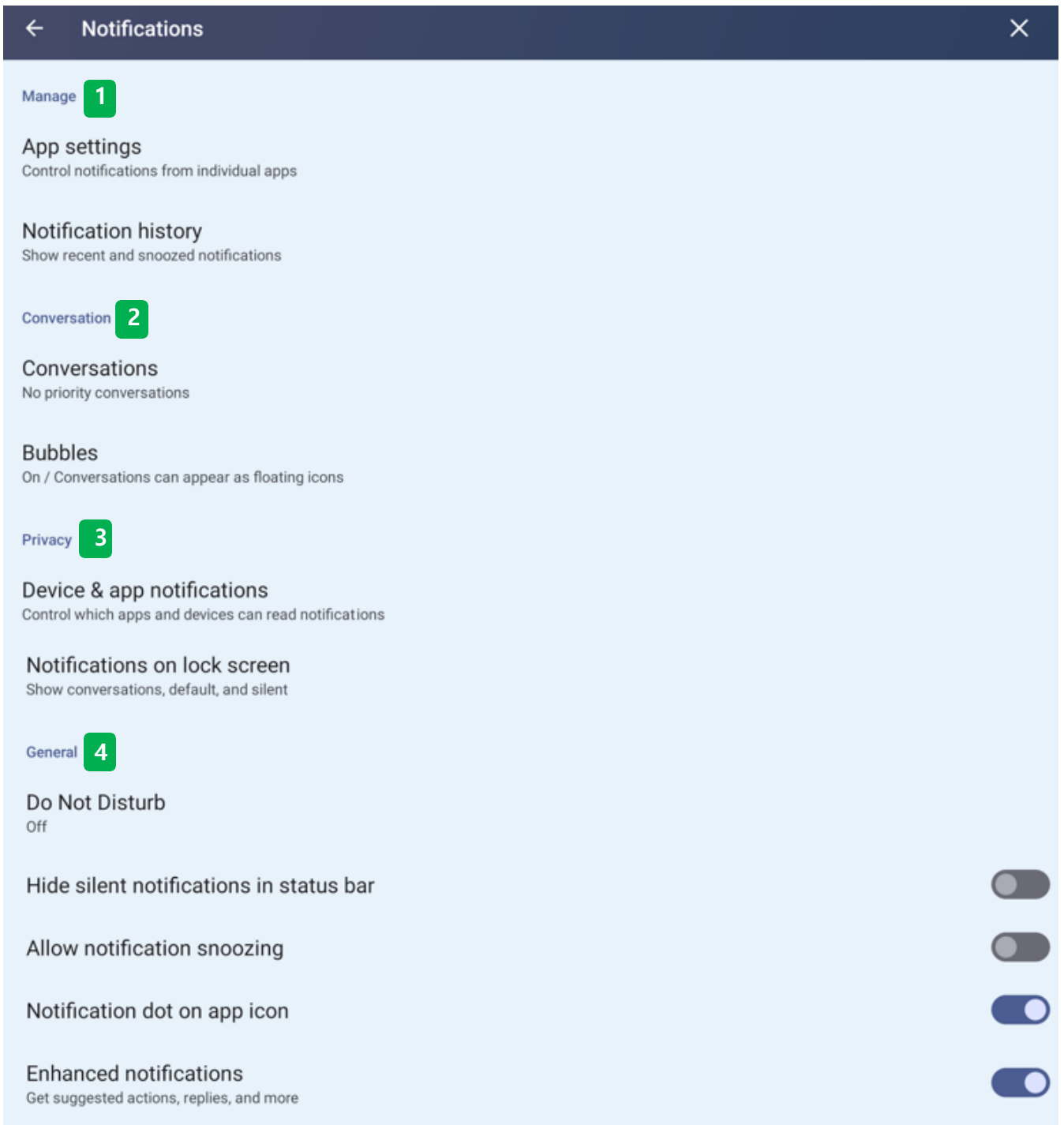

❖ Notifications

- Control the notification features of IFPD.
- Adjust the notification, message, notification method setting for each app.

5.5 Notifications

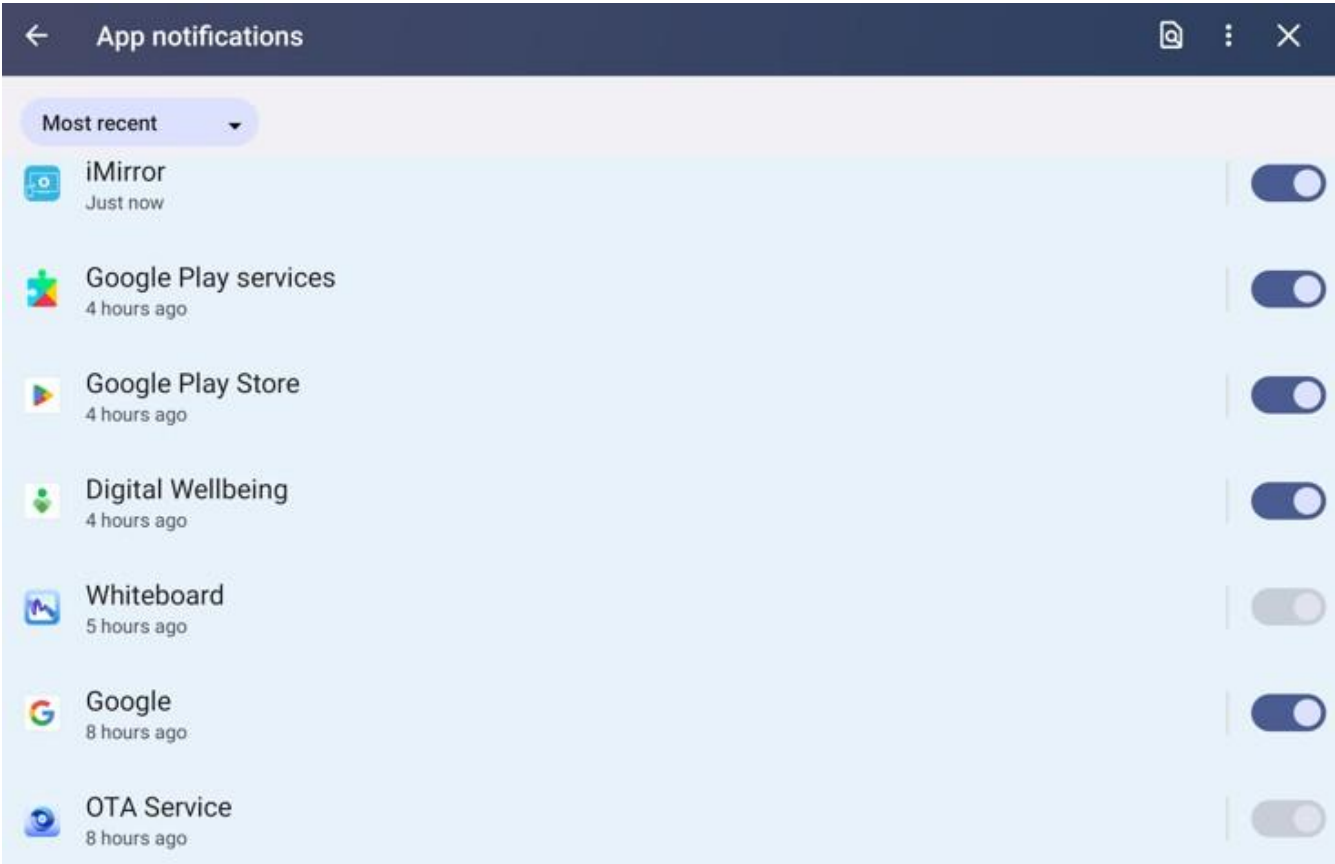

① Manage

- Select whether to display notifications for each app in the App Settings menu
- Notification History menu shows a recent notification and checks a list of paused notifications.

5.5 Notifications

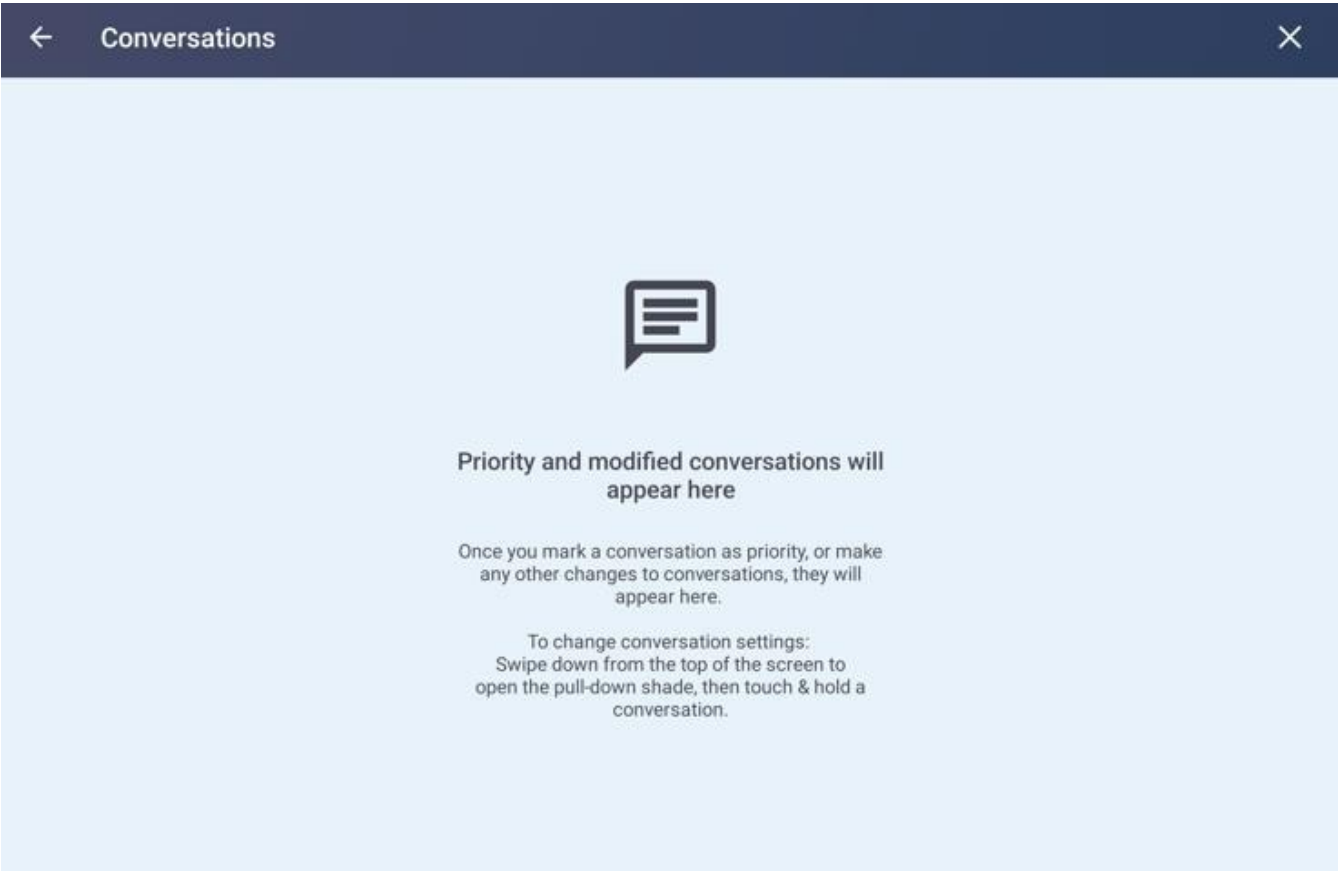

② Conversation

- Conversation menu shows priority conversations and modified conversations.
- Bubbles entries allow some conversations to appear as floating icons over other apps.

5.5 Notifications

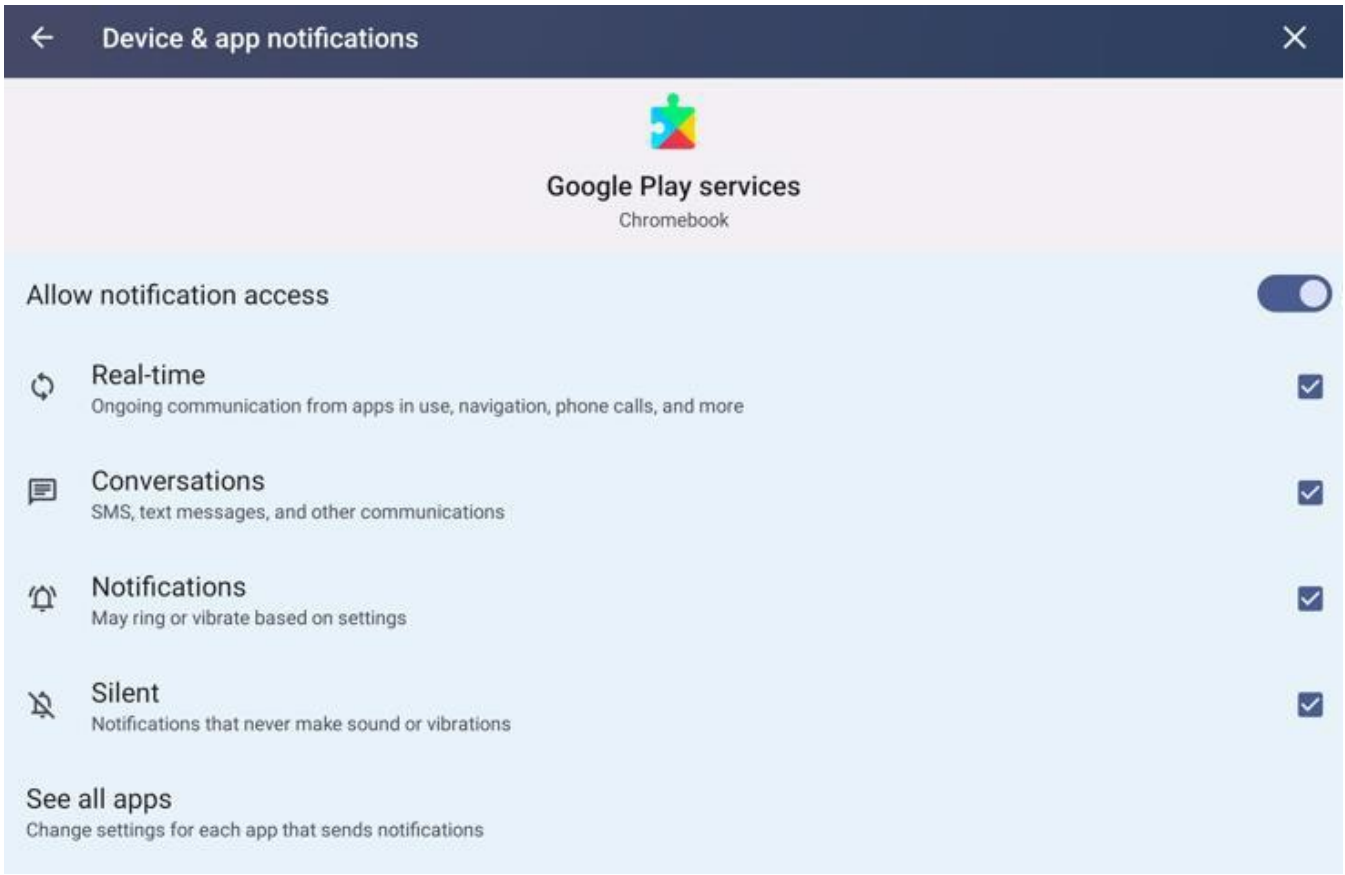
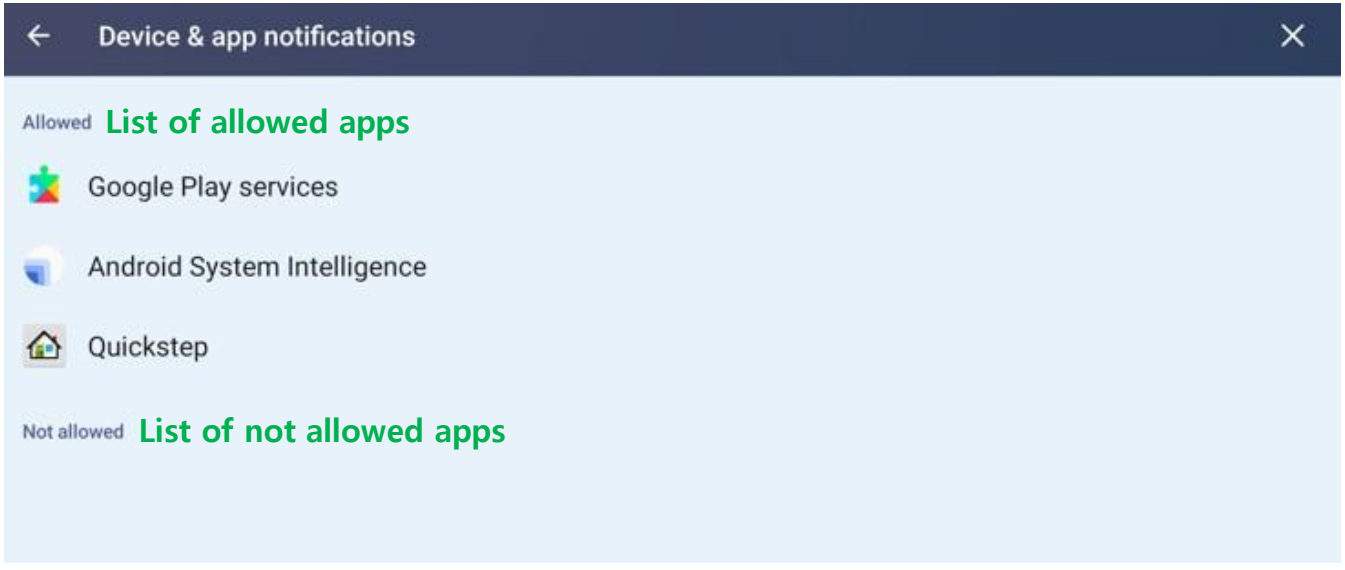

③ Privacy (Device & app notifications)

- In the Device & App Notifications menu, users can set up notification permissions for App to read notifications.
- Users can set up permissions such as notifications, SMS and messages, ringtones notifications, silent notifications in real time.

5.5 Notifications

Notifications on lock screen

- Show conversations, default, and silent
- Hide silent conversations and notifications
- Don't show any notifications

③ Privacy (Notifications on lock screen)

- Notifications On Lock Screen menu allows you to change the notification status to display on the lock screen.
- Select manu, show all conversations and default and silent notifications, hide silent conversations and notifications, select the Do not Show all Notifications.

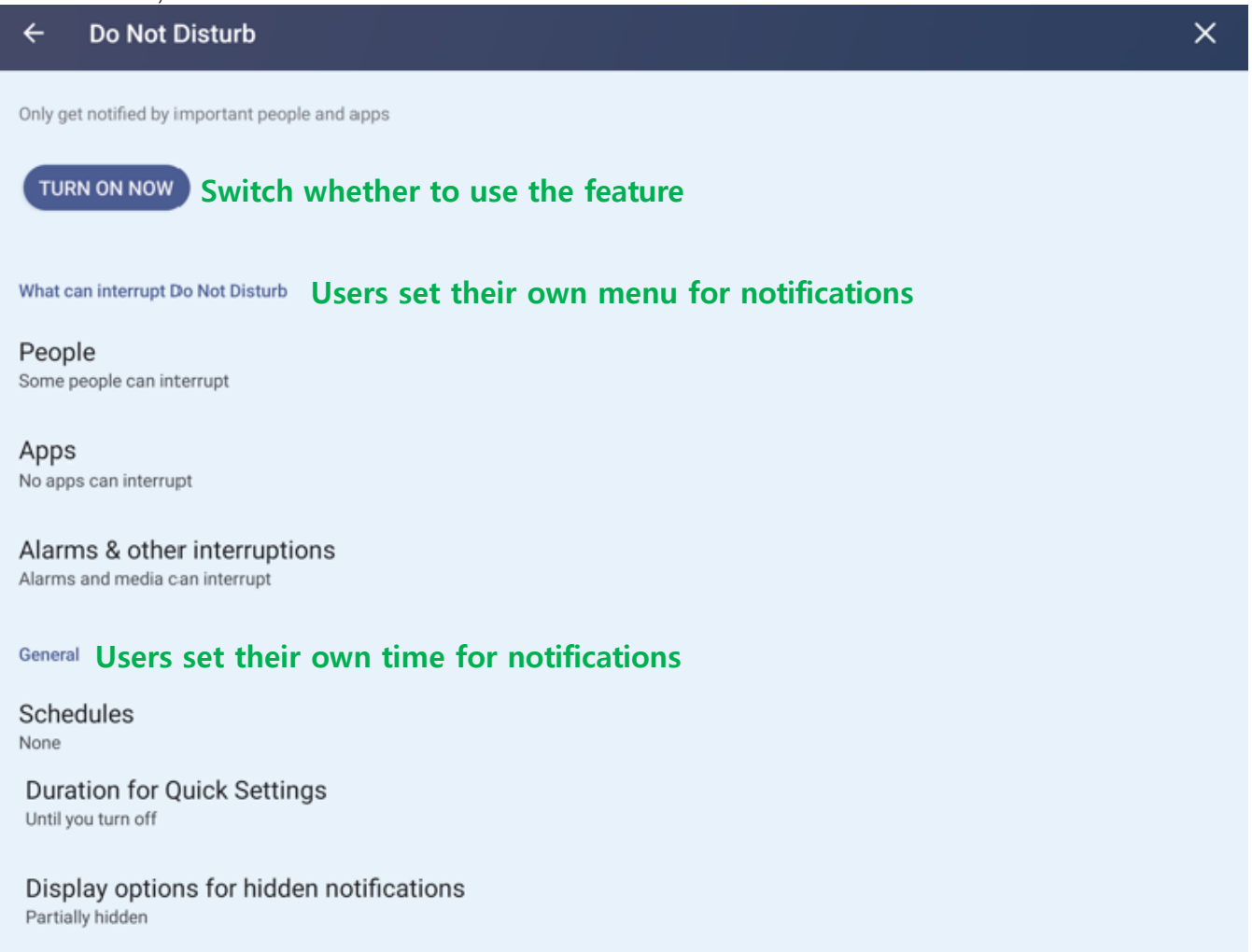

④ General (Do Not Disturb)

- The Do Not Disturb feature allows users to control which notifications appear on IFPD.
- Users can directly specify a menu with a notification through the exception menu.
- The Schedule feature allows users to enable the notification feature only at a set time.

5.5 Notifications

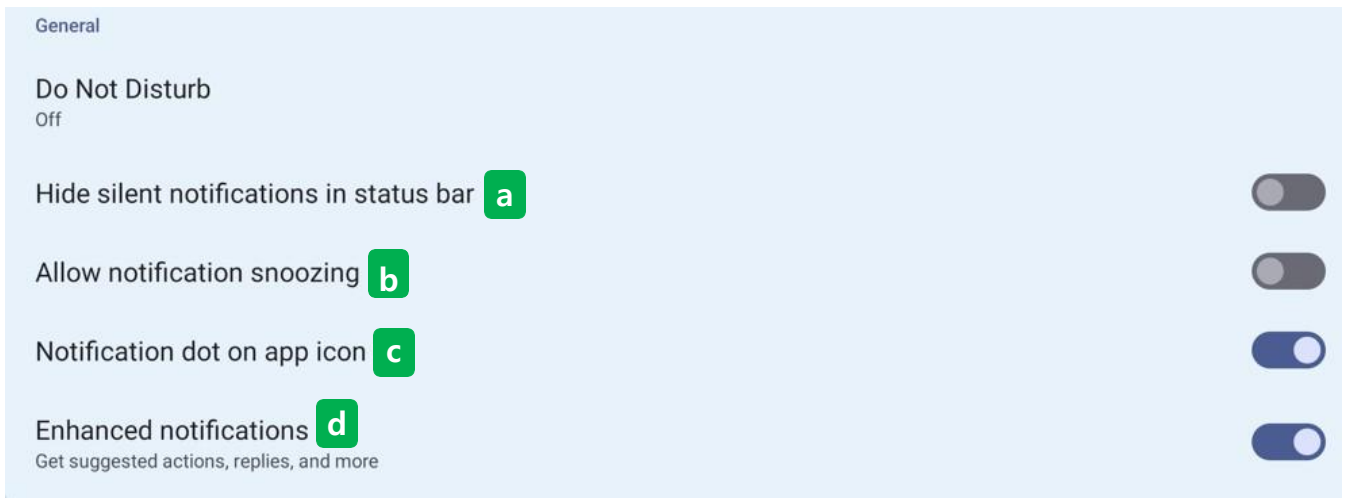

④ General

ⓐ Hide silent notifications in status bar

- Hide silent notifications in status bar.
- The status bar appears when you drag a touch from the top to the bottom of the home screen.

ⓑ Allow notification snoozing

- Allows users to receive the notifications users received once again.

ⓒ Notification dot on app icon

- When the notification comes, the app icon is displayed as a dot.

ⓓ Enhanced notifications

- This feature displays recommendation and reply and summarizes notifications.
- Users can access the notification contents that contain personal information such as contact information and message. It is also possible to close or handle notifications, such as receiving a phone call and controlling the interference mode.

5.6 Storage

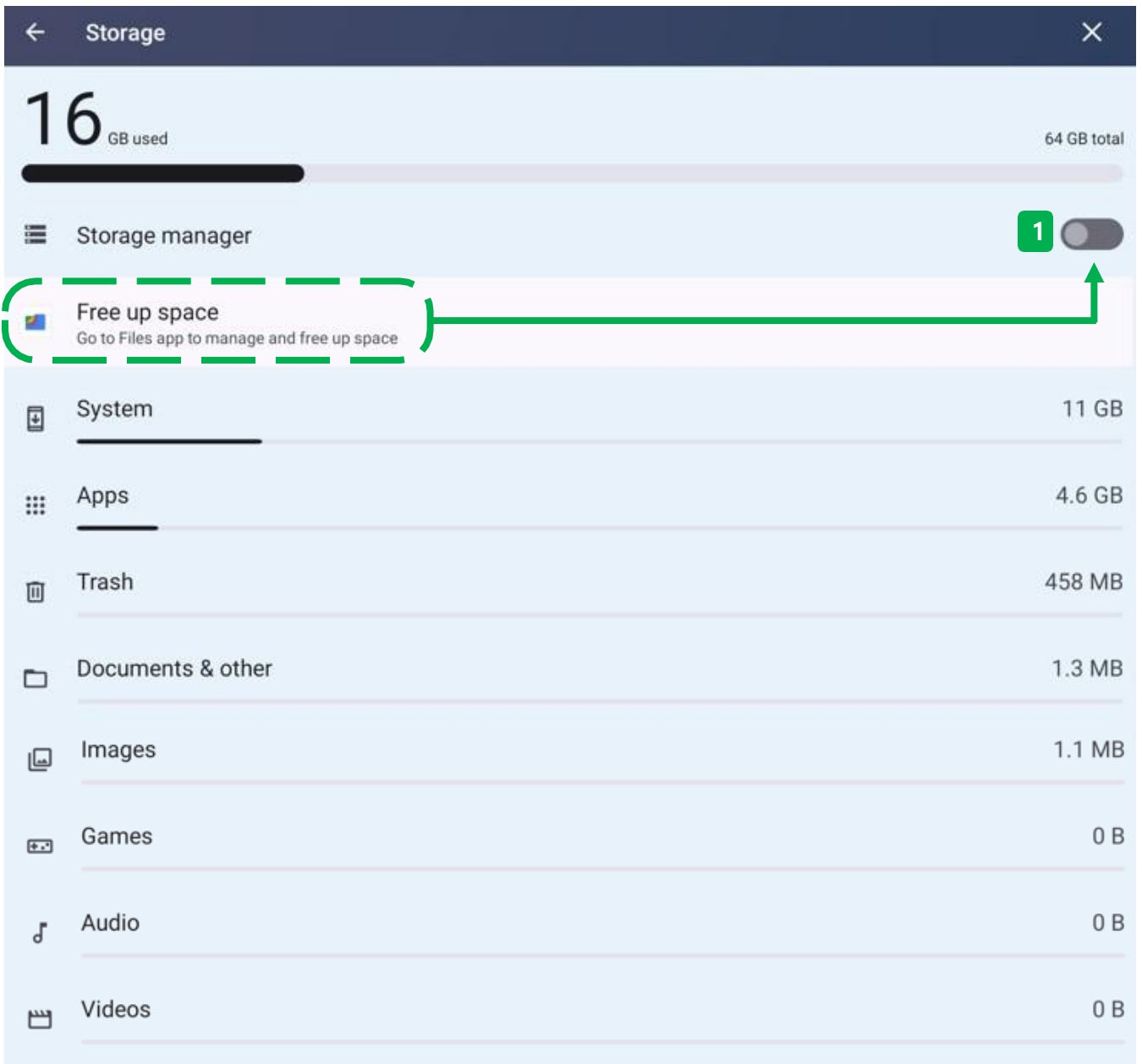

❖ Storage

- Users can see the amount of storage on IFPD Android system and a list of files divided into categories.

① Storage manager

- Google-based systems support internal file organization, file search, and Nearby Share file sharing.

5.6 Storage

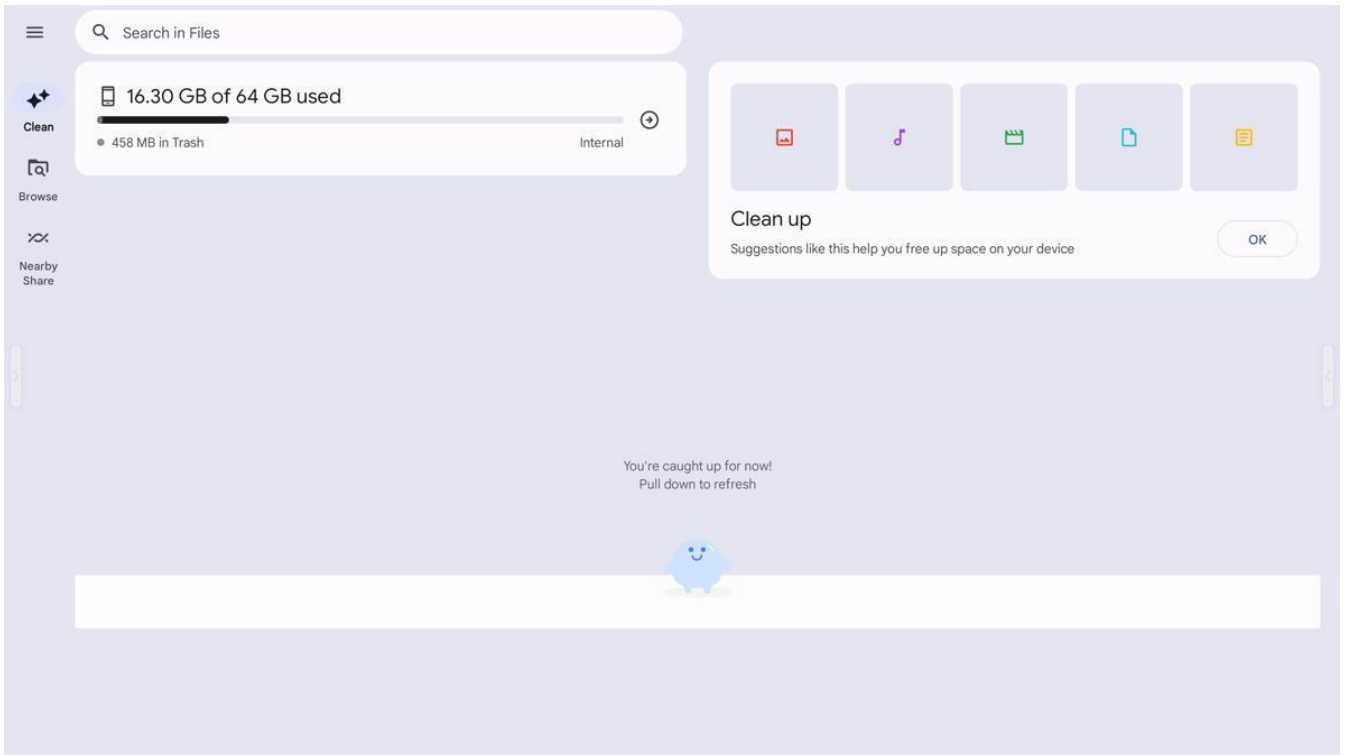

① Storage manager

- Google-based systems support internal file organization, file search, and Nearby Share file sharing.

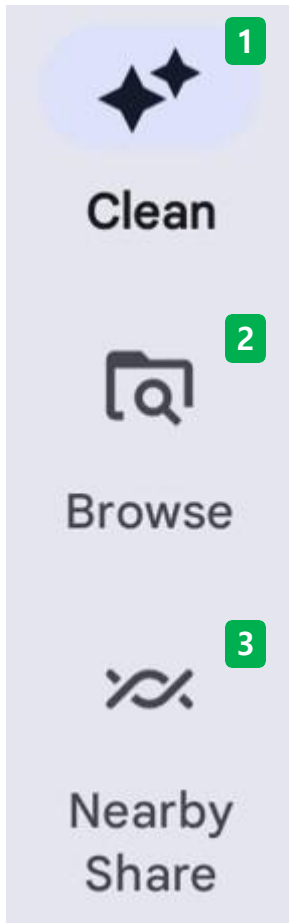

① Clean

- Internal storage cleanup, including deleting unnecessary files and clearing cache

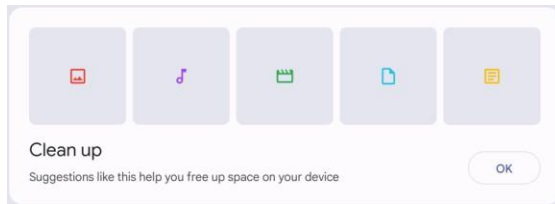

② Browse

- Divide into categories to view the list of files.



③ Nearby Share

- Sharing works with the electronic blackboard to share files such as photos, videos, and apps.

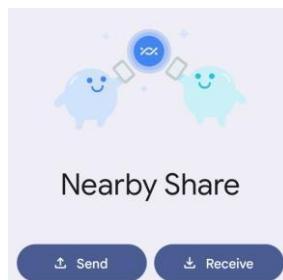

5.7 Sound & vibration



❖ Sound & vibration

- Users can adjust the functions related to the sound of IFPD

❖ Volume bar

- Ⓐ Adjust IFPD default volume.
- Ⓑ Adjust the volume of incoming calls through IFPD.
- Ⓒ Adjust the volume of the alarm function on IFPD.
- Ⓓ Adjust the volume of the notification pane on IFPD.

5.7 Sound & vibration

1 Do Not Disturb

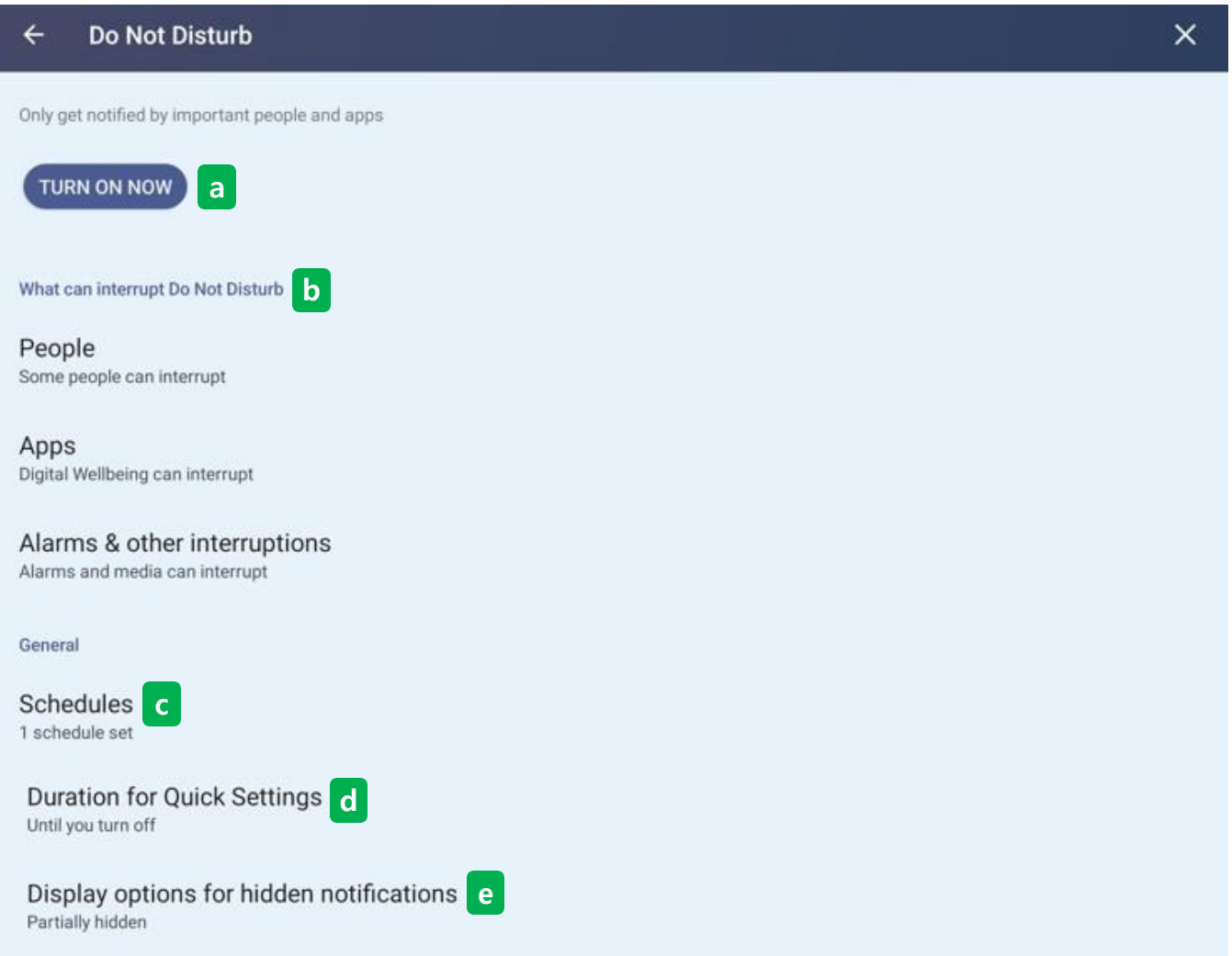

a Turn on now

- Click to turn the Do Not Disturb feature on or off.

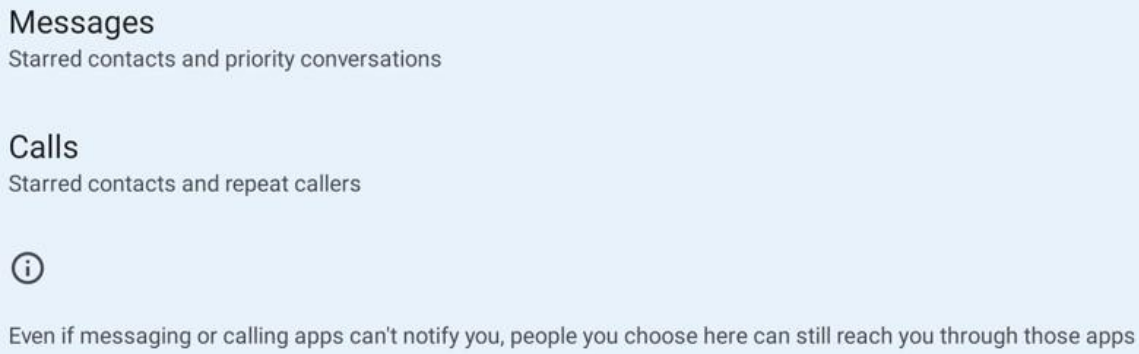

b What can interrupt Do Not Disturb

1. People (Messages)
 - Set the exception by selecting the following items: Starred contacts, Contacts, Priority conversations, All users, None..
2. People (Calls)
 - Calls : Set the exception by selecting the following items: Starred contacts, Contacts, All users, None.

5.7 Sound & vibration

① Do Not Disturb

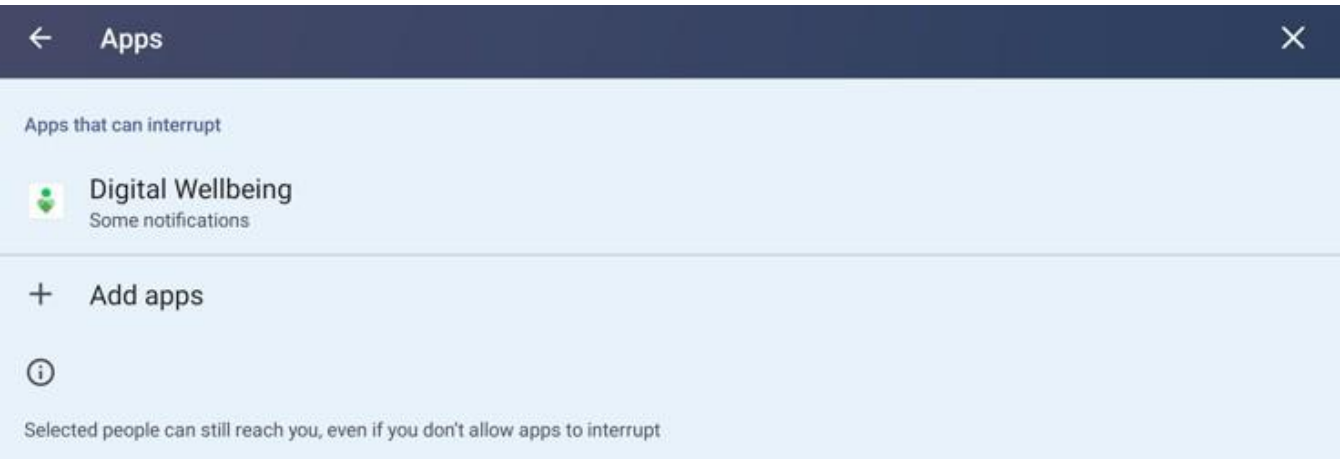

② What can interrupt Do Not Disturb

- 3. Apps
 - Add an exception app entry for the Do Not Disturb feature by selecting the "+ Add Apps" part.
 - Notifications from apps added to the item will always work.



- 4. Alarms & Other interruptions
 - Select the Other distractions item to specify as an exception to the Do Not Disturb feature.
 - Alarm, media volume (media sound of video, game, etc.), touch sound (keyboard and other button sound), reminder, calendar etc

5.7 Sound & vibration

① Do Not Disturb

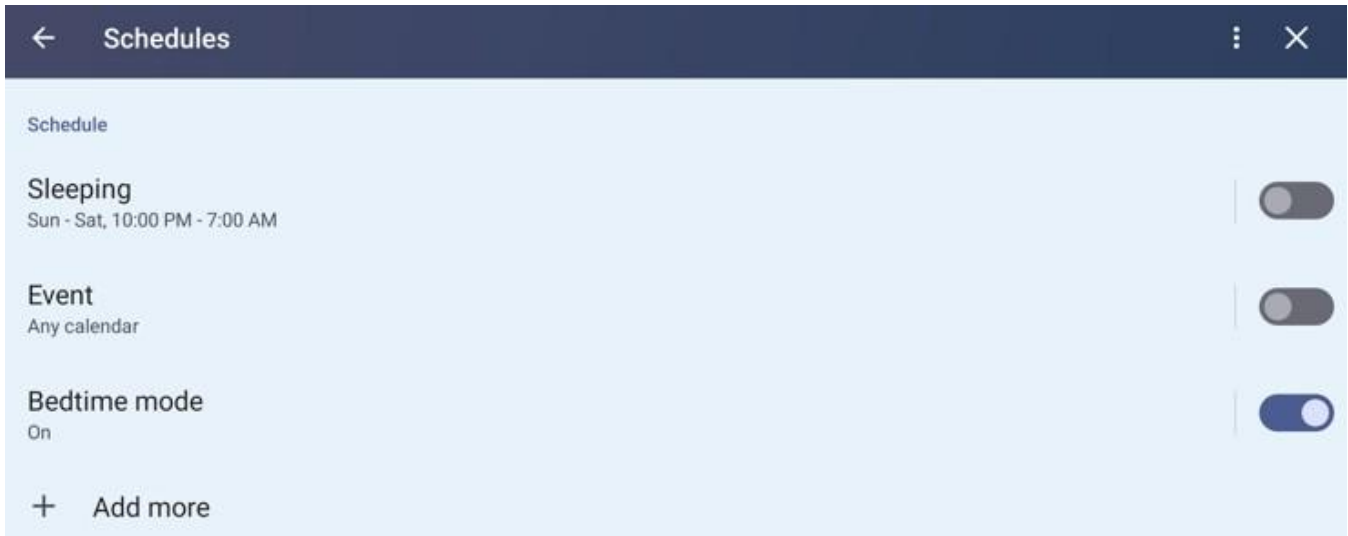

② Schedules

1. Sleeping
 - Disable notifications from acting during user-set times.
2. Event
 - Disable notifications from working on dates set by the user.
3. Bedtime mode
 - Disable behavior during user-set times (bedtime).
4. Add more
 - Set it to not work at a specific time, date, or when the app is in use.

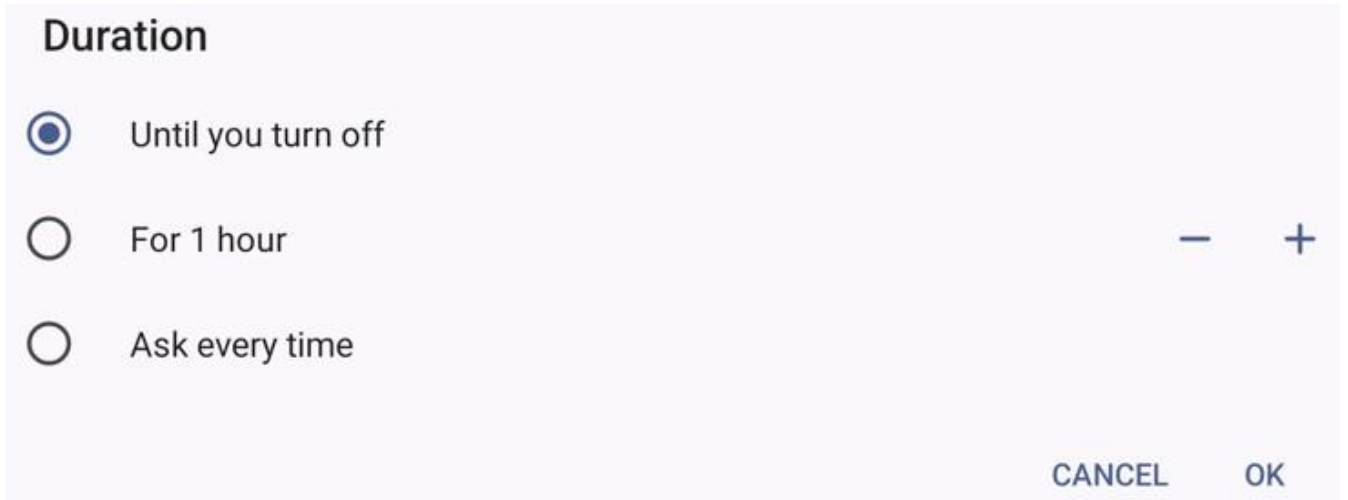

③ Duration for quick settings

- The Do not Disturb mode function works quickly with simple settings.
- Until users stop using it, users can always select three types of confirmation during the set time.

5.7 Sound & vibration

① Do Not Disturb

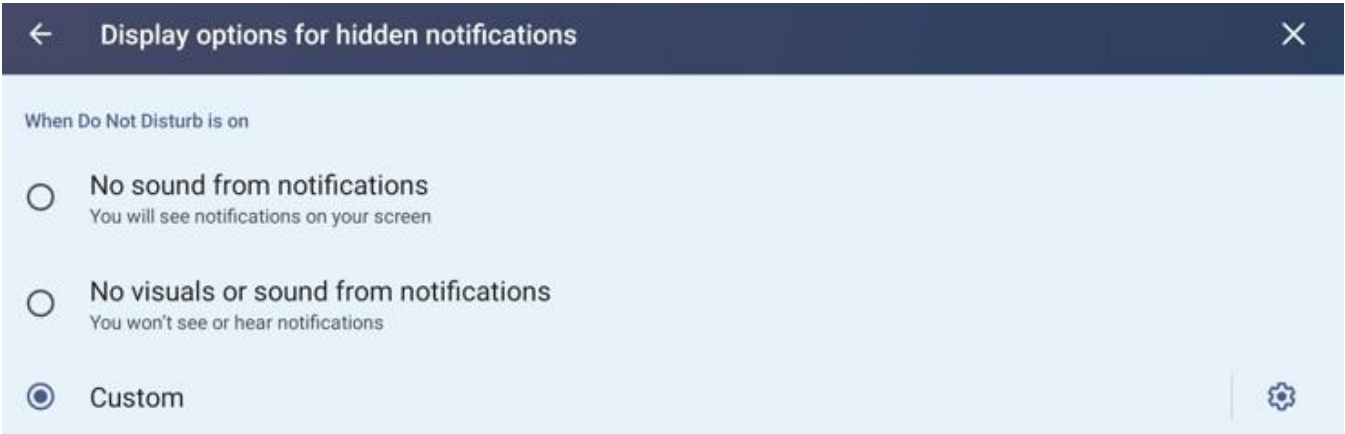

② Display options for hidden notifications

- 1. No sound from notifications
 - When checked, blocks notification sounds when using the Do Not Disturb feature.
- 2. No visuals or sound from notifications
 - When selected, blocks the display and sound of notifications when using the Do Not Disturb feature.

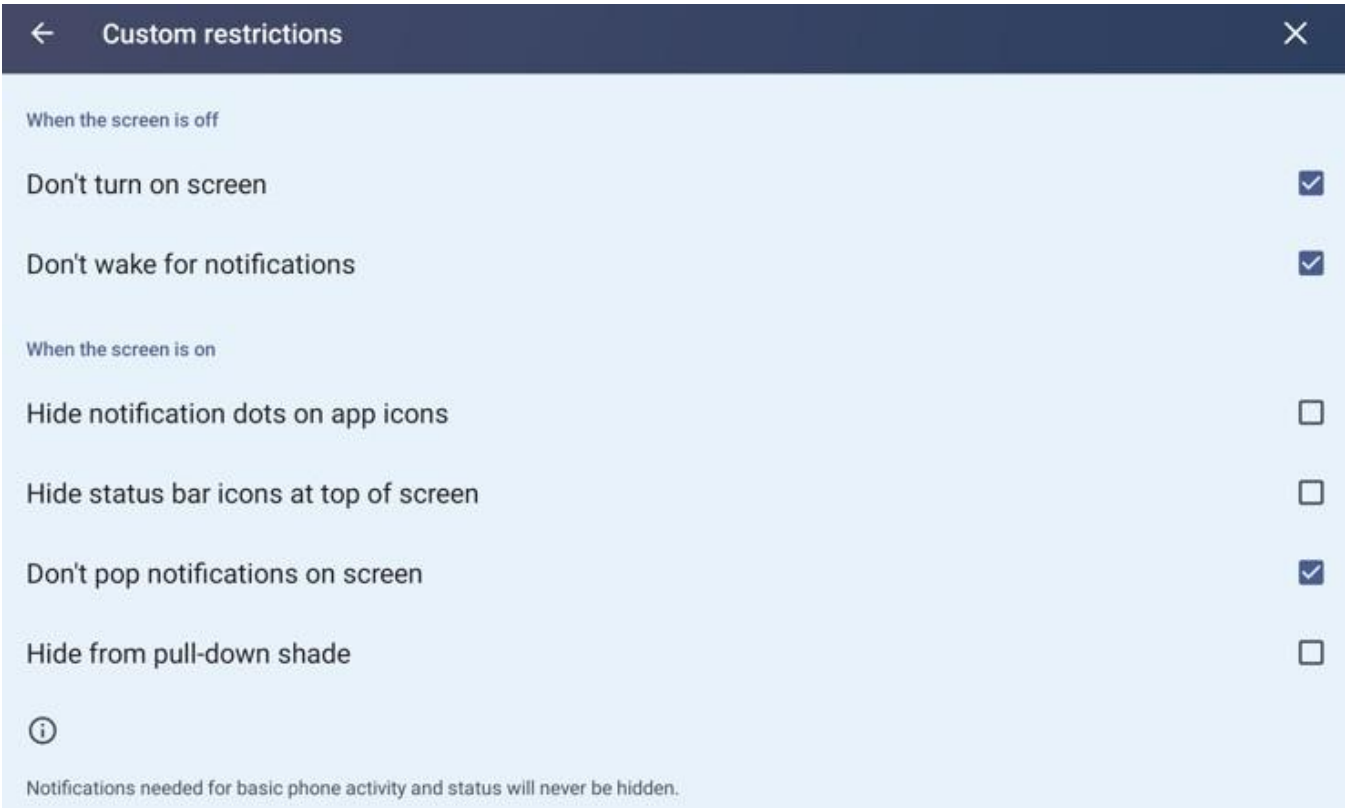

- 3. Custom
 - Sets the operational status of the Do Not Disturb mode function when the screen IFPD is turned off or on.
 - When the screen is off : Do not turn on the screen, do not turn on the screen when receiving notifications
 - When the screen is on: Hide notifications in the APP icon, hide the top status bar icon, no screen notification indicator. The user can choose directly, such as hiding it in the pull-down window.

5.7 Sound & vibration

② Live caption

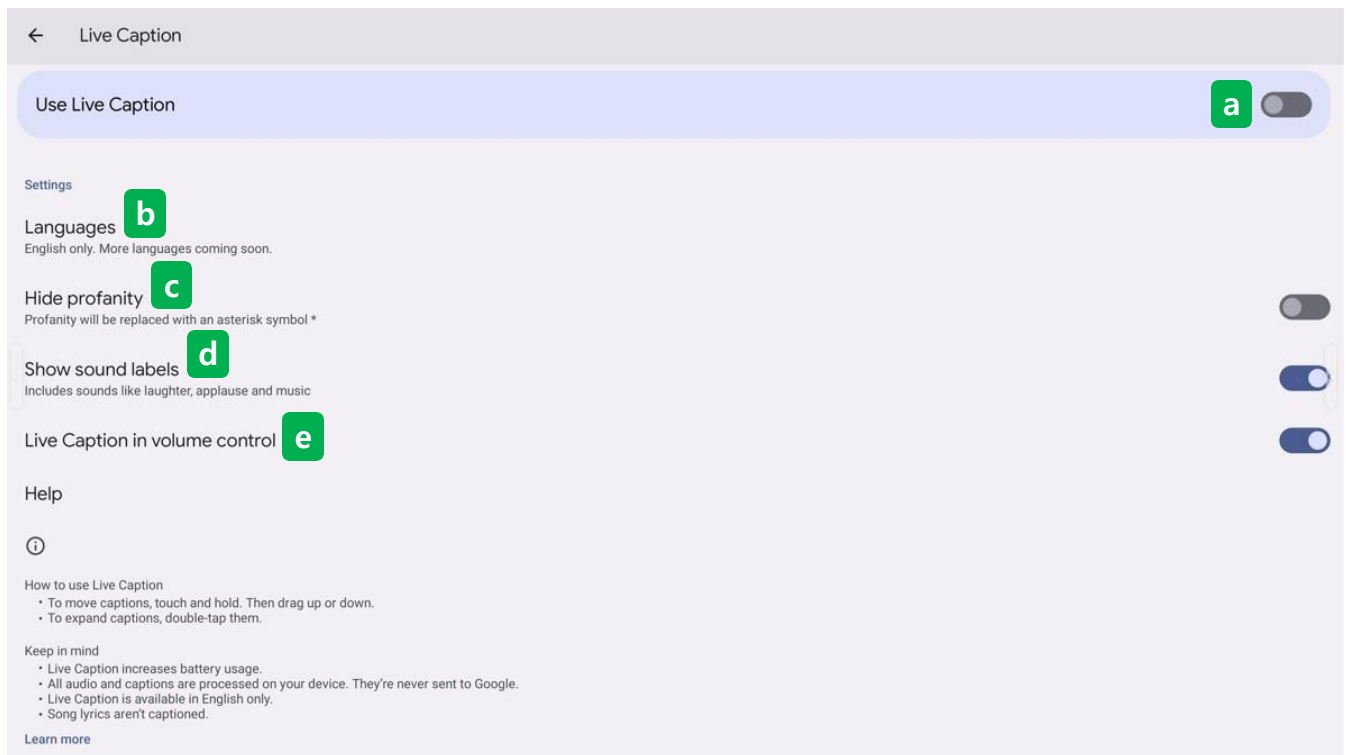

Ⓐ Use live caption

- Click to turn real-time subtitles on or off.

Ⓑ Languages

- The current language is provided only in English, and other languages will be supported soon.

Ⓒ Hide profanity

- When the function is turned on, the swear words of the subtitles are replaced by the asterisk (*).

Ⓓ Show sound labels

- Sounds such as laughter, applause, and music are also labeled.

Ⓔ Live caption in volume control

- Use real-time subtitles in the part that adjusts the volume size.

① Feature supplement descriptions

1. How to use real-time subtitles

- To change the position of the subtitle, touch and hold. Then drag it up or down.
- Tap twice to spread the subtitles.

2. caution

- Real-time subtitles increase data usage.
- All audio and subtitles are processed on the device and are never sent to Google.
- Real-time subtitles are available only in English.
- Subtitles for song lyrics are not generated.

5.7 Sound & vibration

③ Media

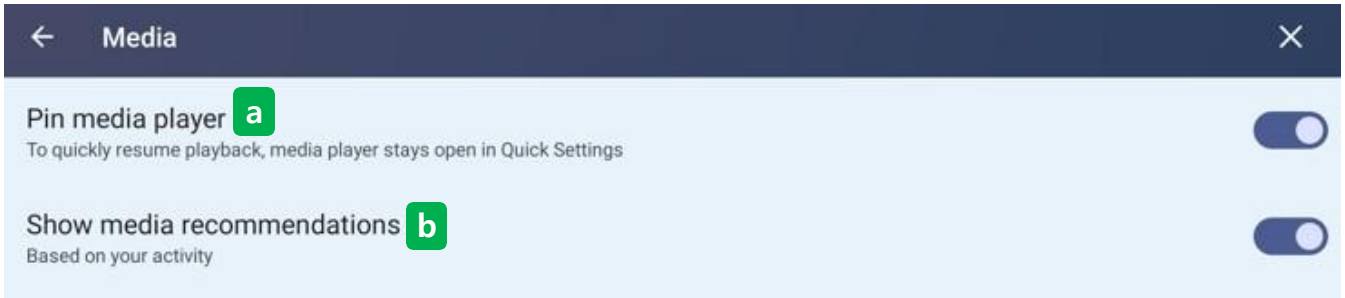

Ⓐ Pin media player

- To quickly resume playback media player stays open in Quick Settings.

Ⓑ Show media recommendations

- Show media recommendations. Receive recommendations based on a user's activity.

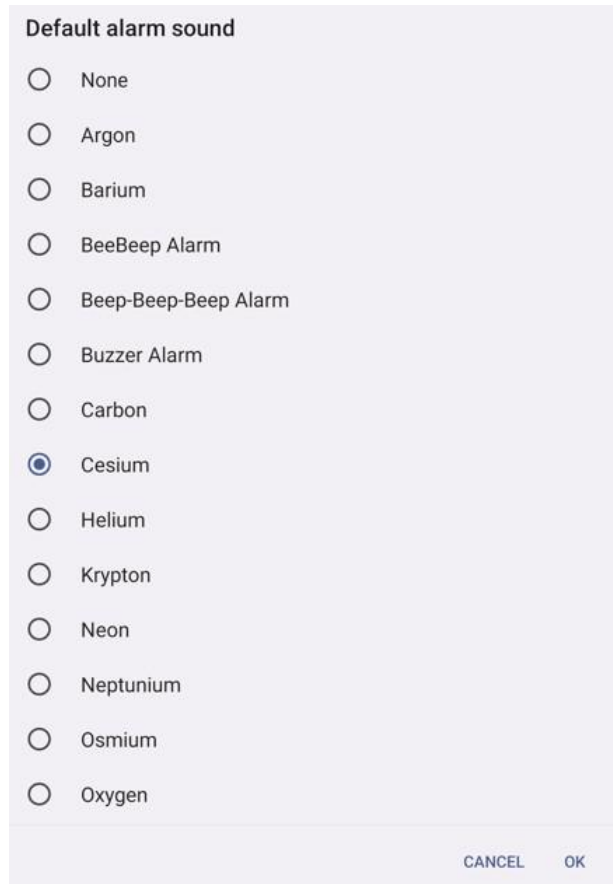
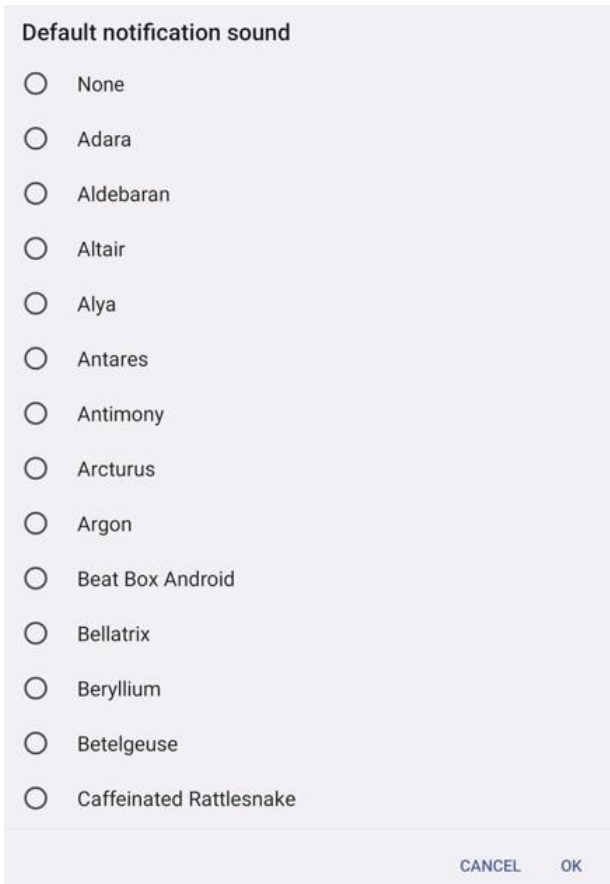

④, ⑤ Default notification sound & Default alarm sound

- The notifications and alarm sounds are changed to the sound users want.

❖ Default sound

- Sets the sound that comes out when the notification and alarm functions are activated.

5.7 Sound & vibration

Screen locking sound **6**



Charging sounds and vibration **7**



Touch sounds **8**



Always show icon when in vibrate mode **9**



⑥ Screen locking sound

- Set the sound operation of the screen lock function.

⑦ Charging sounds and vibration

- Set the charging sound and vibration function operation.

⑧ Touch sounds

- On the Android screen, set the touch sound operation when touching.

⑨ Always show icon when in vibrate mode

- Sets whether to always show as an icon when in vibrate mode.

5.8 Display

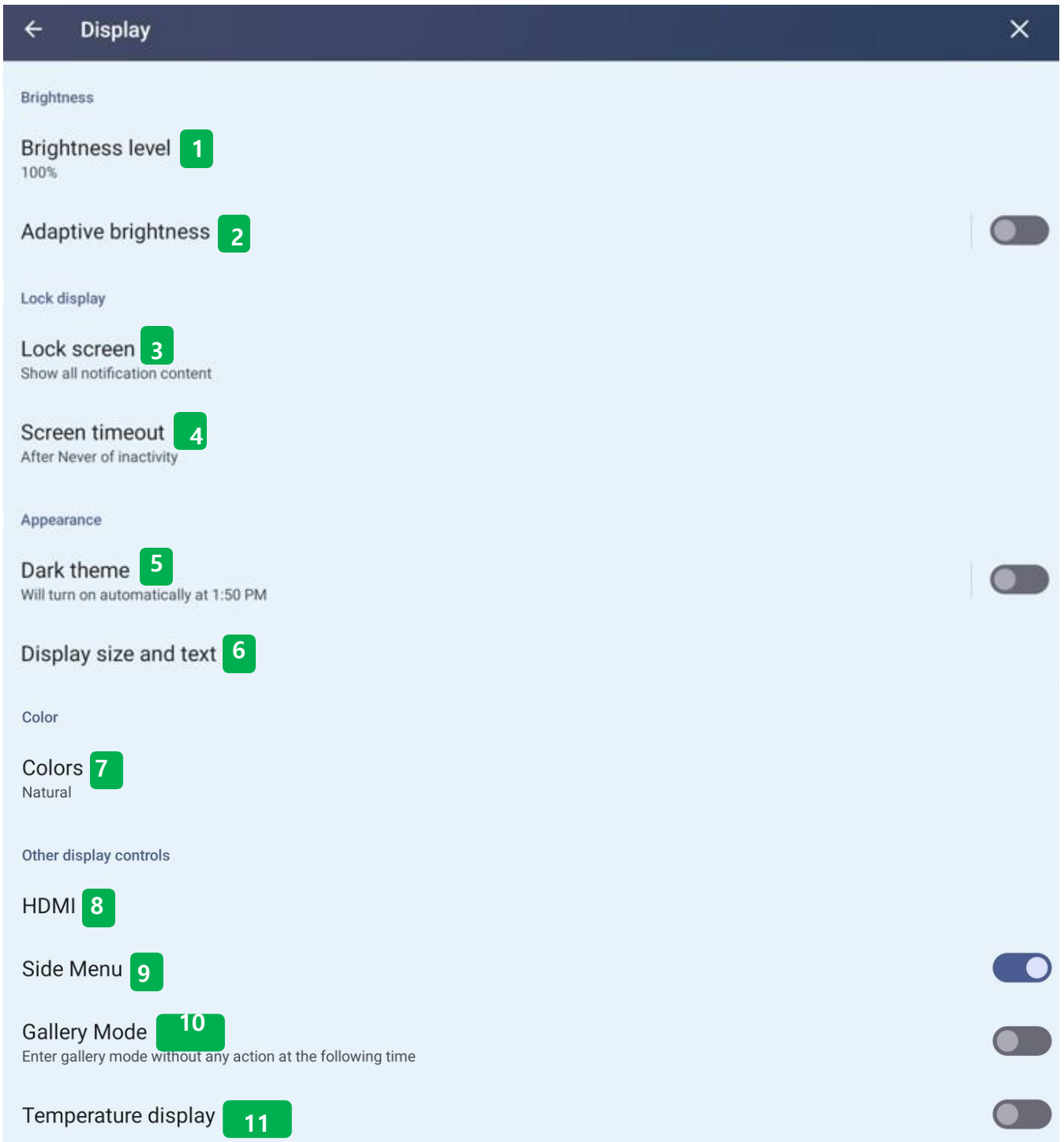

❖ Display

- In the display settings, users can set the screen brightness, lock screen, Android UI color and font, HDMI out resolution, side menu, PM2.5 index, and product temperature.

5.8 Display

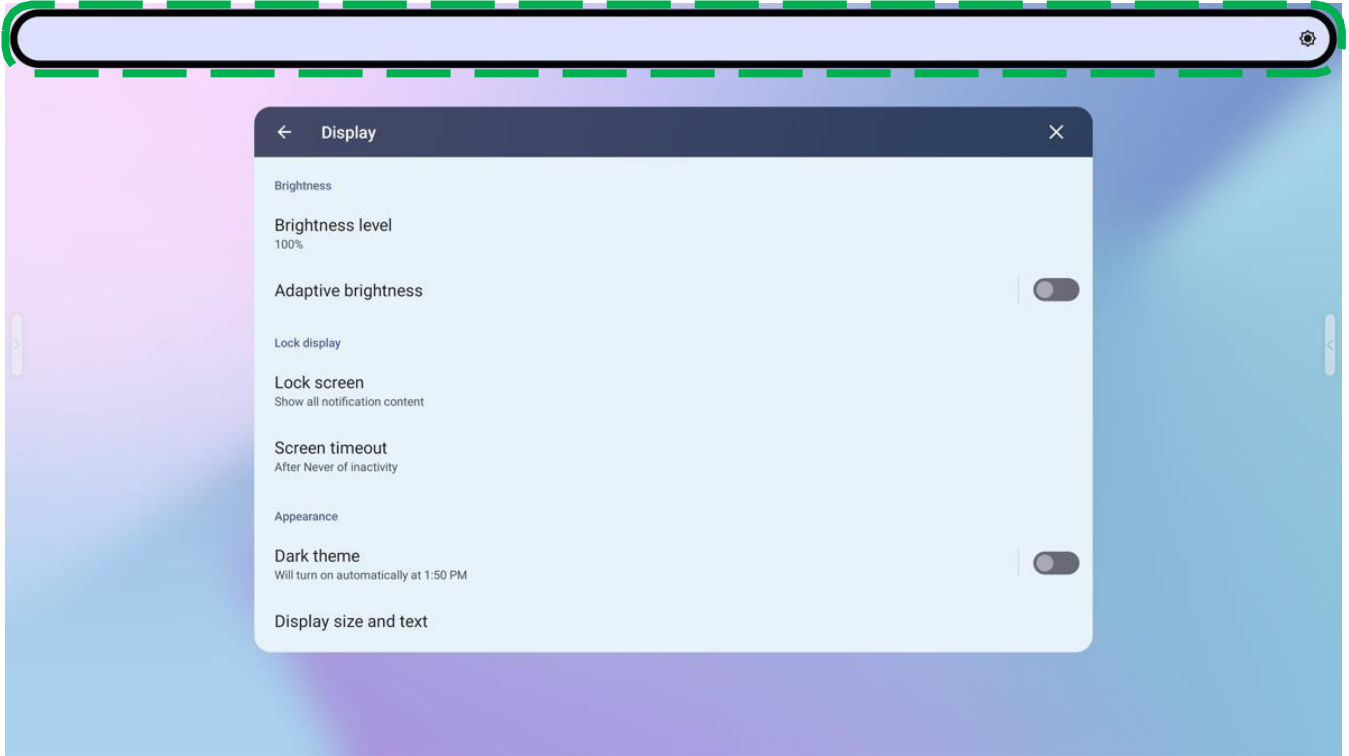

① Brightness level

- When a user touches the above-indicated part of the screen, a window will appear where they can adjust the brightness of the display. Brightness can be adjusted between 0 and 100% (the default value is set to 80%).

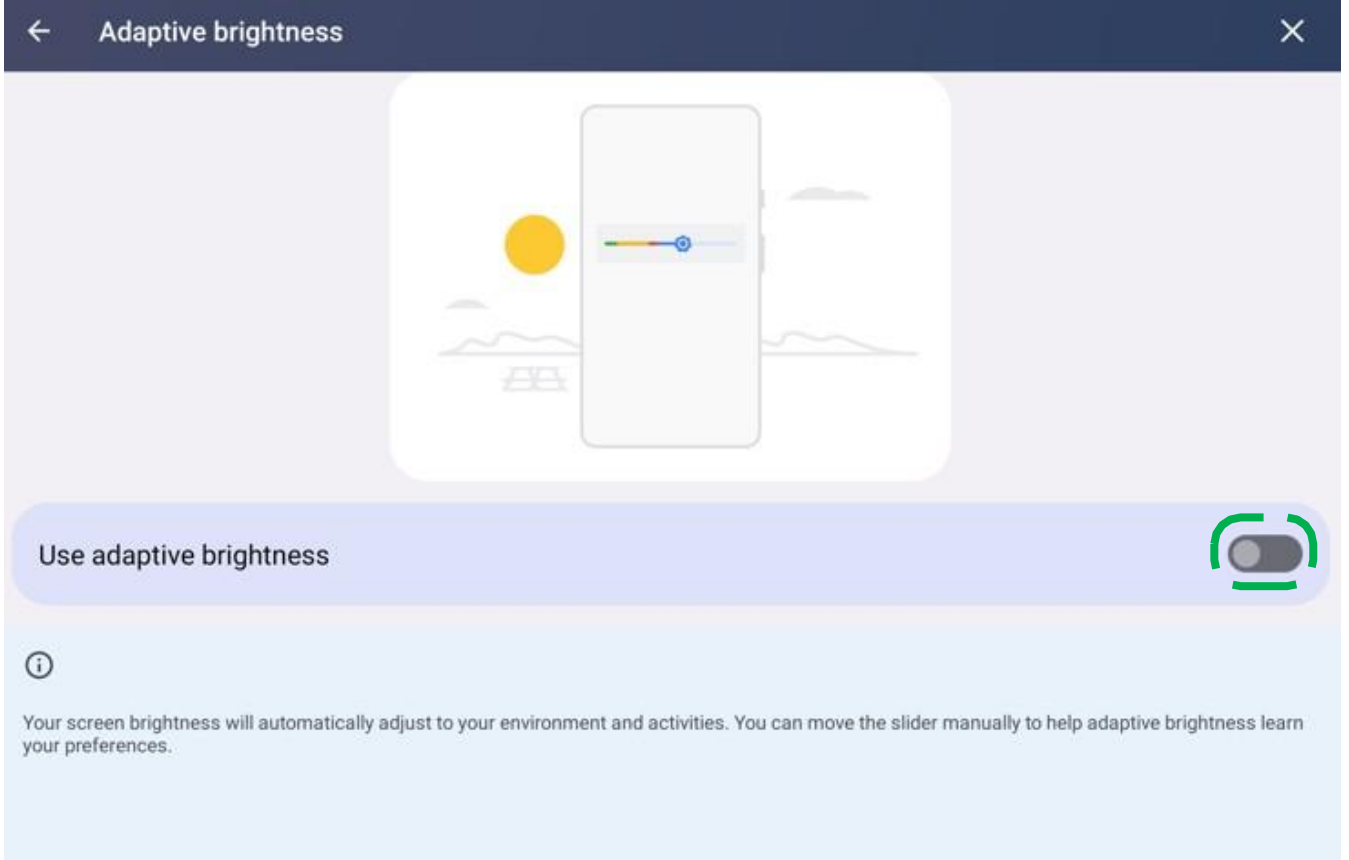

② Adaptive brightness

- The brightness of the display changes automatically to match the ambient brightness.

5.8 Display

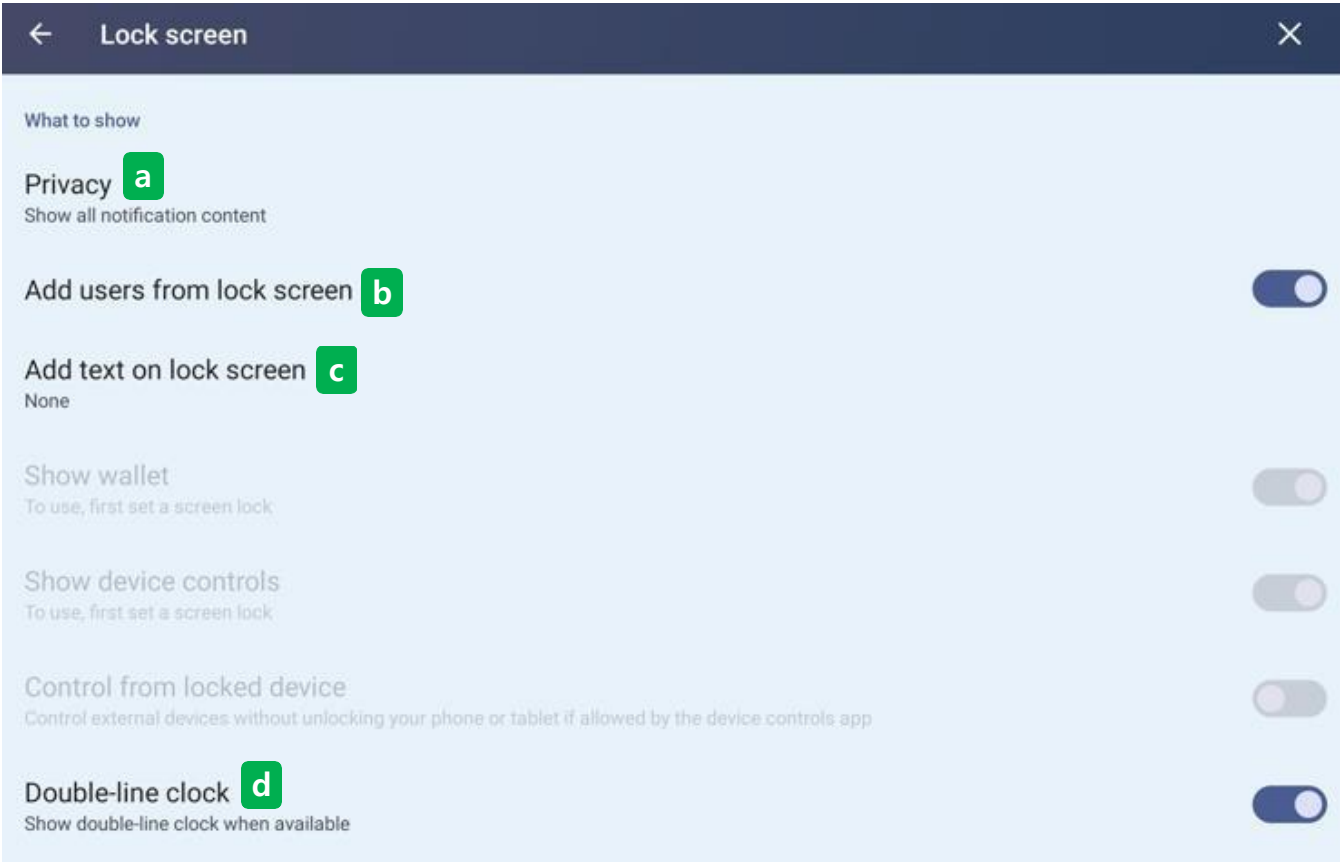

③ Lock screen

- Set the display methods such as images, letters, and clocks that appear when IFPD is locked.

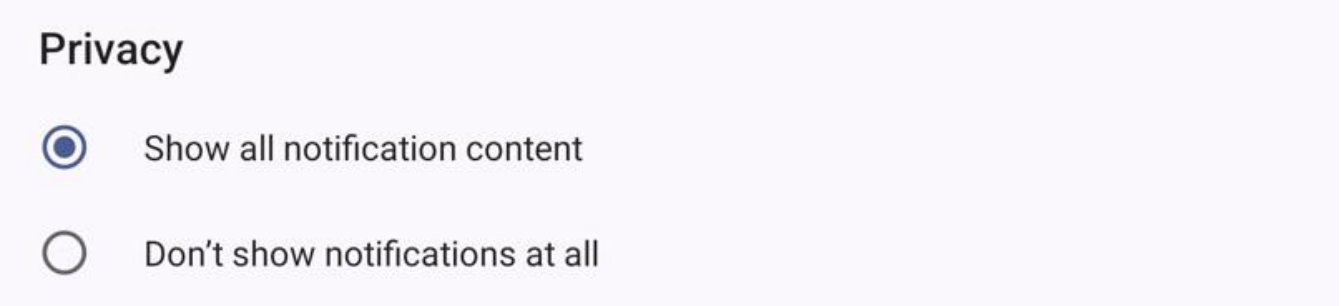

Ⓐ privacy

- When select the Privacy menu, users choose whether to display notifications IFPD is on the lock screen.

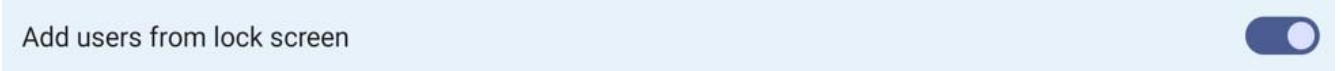

Ⓑ Add users from lock screen

- When turn on the feature, users can add a Google user account to IFPD in the lock screen state.

5.8 Display



③ Add text on lock screen

- Type the letters that appear at the bottom of the screen when the screen is locked. These letters appear at the bottom of the screen when set.



④ Double-line clock

- Sets whether the time display that appears when the lock screen state is displayed in two lines.



④ Screen timeout

- If the display is not used for the set time, it automatically switches to the locked screen state. (only the screen is turned off)

5.8 Display

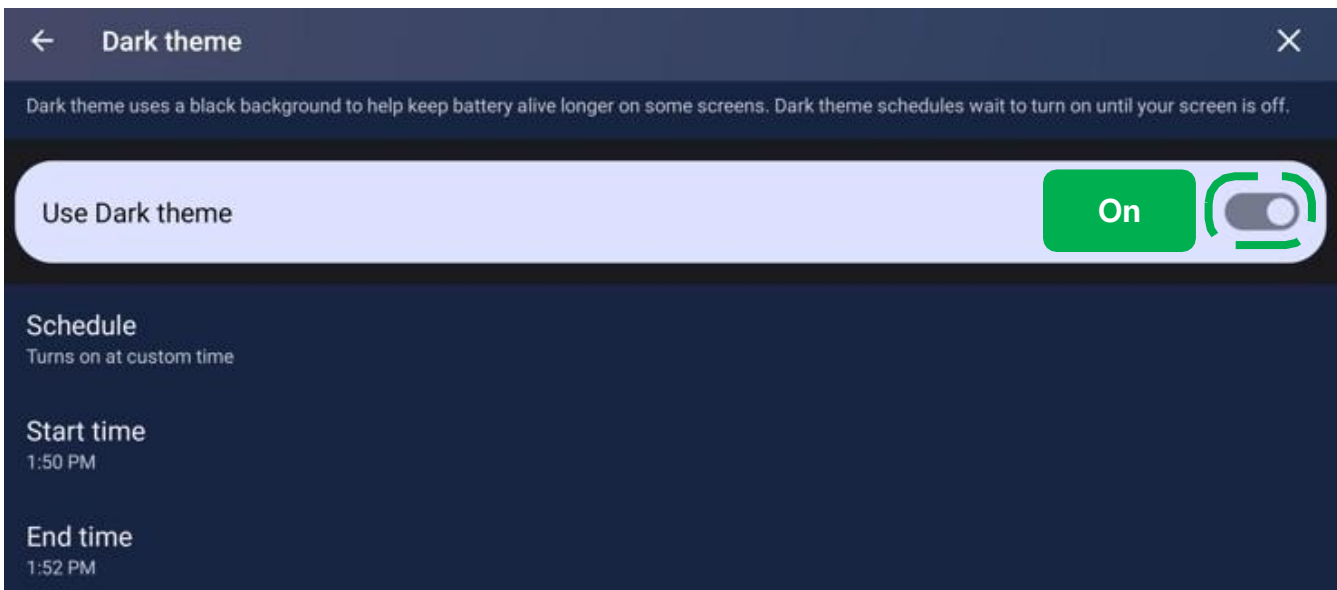
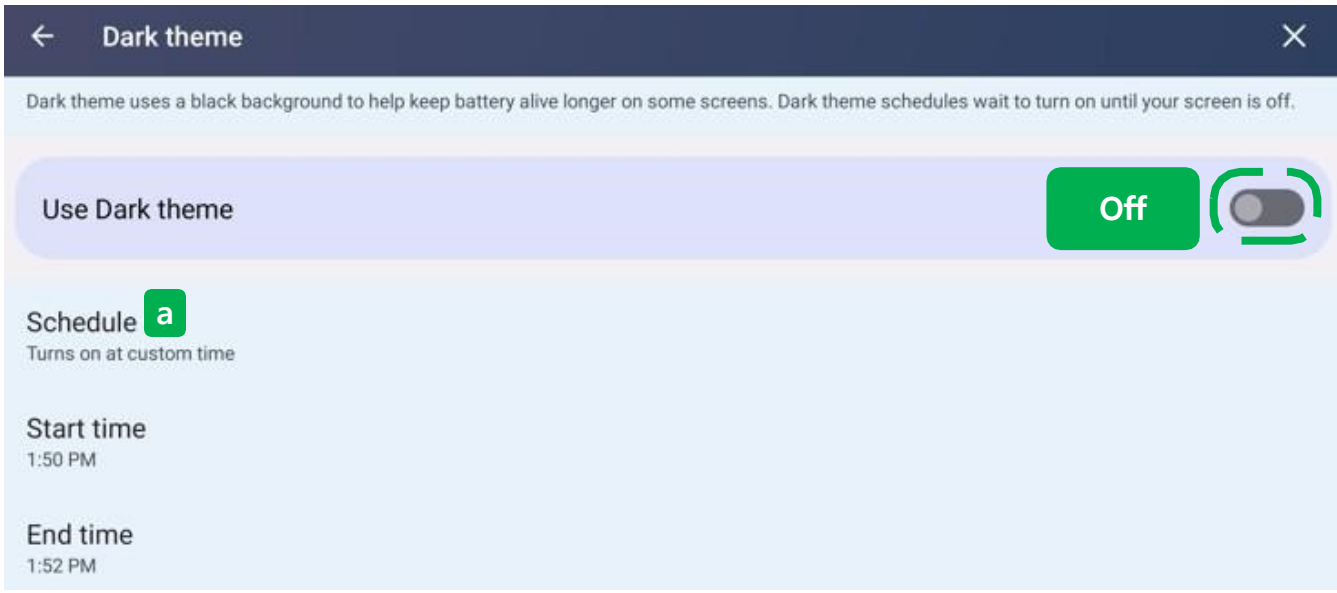

⑤ Dark theme

- When using a dark theme, the display's Android UI will be changed to dark color as a whole.

ⓐ Schedule

- If users set the dark theme schedule, the function will automatically turn on when you switch to the lock screen after the set time.
- If the time is set for the function to turn on and off, the function is turned off when go to the lock screen after the set time.

5.8 Display

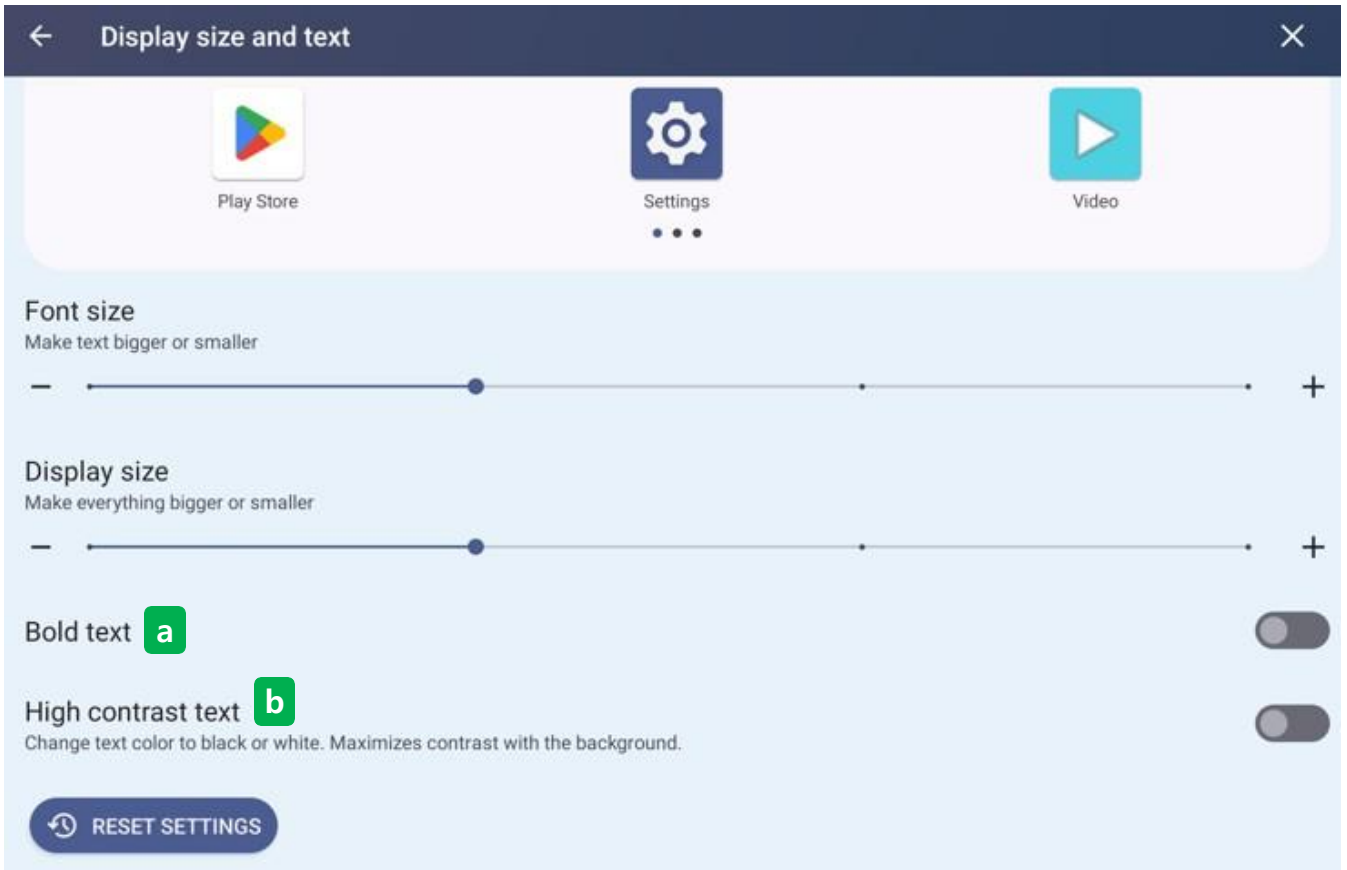

④ Display size and text

- Adjust the overall UI and font size, boldness, and more as seen on the Android screen.

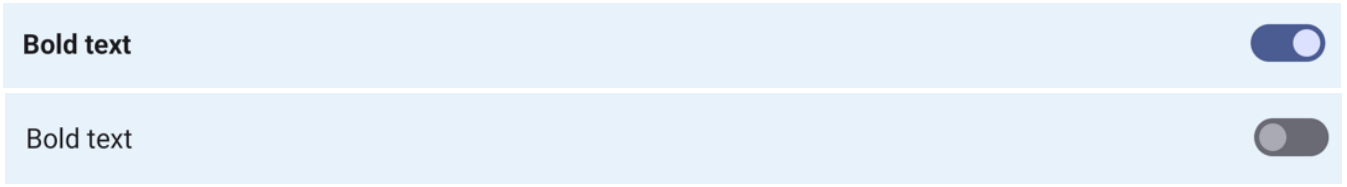

⑤ Bold text

- Choose whether to bold the font on the Android screen.

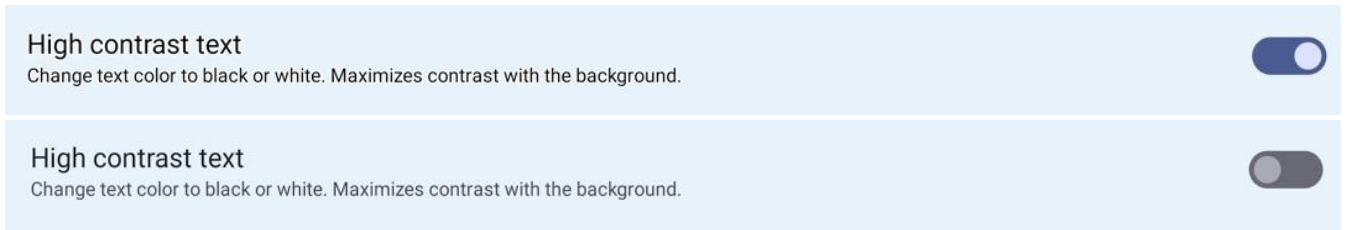

⑥ High contrast text

- Change the text color to black or white. Maximizes contrast with the background.



5.8 Display



⑦ Color

- Check the degree of screen color on IFPD.

5.8 Display

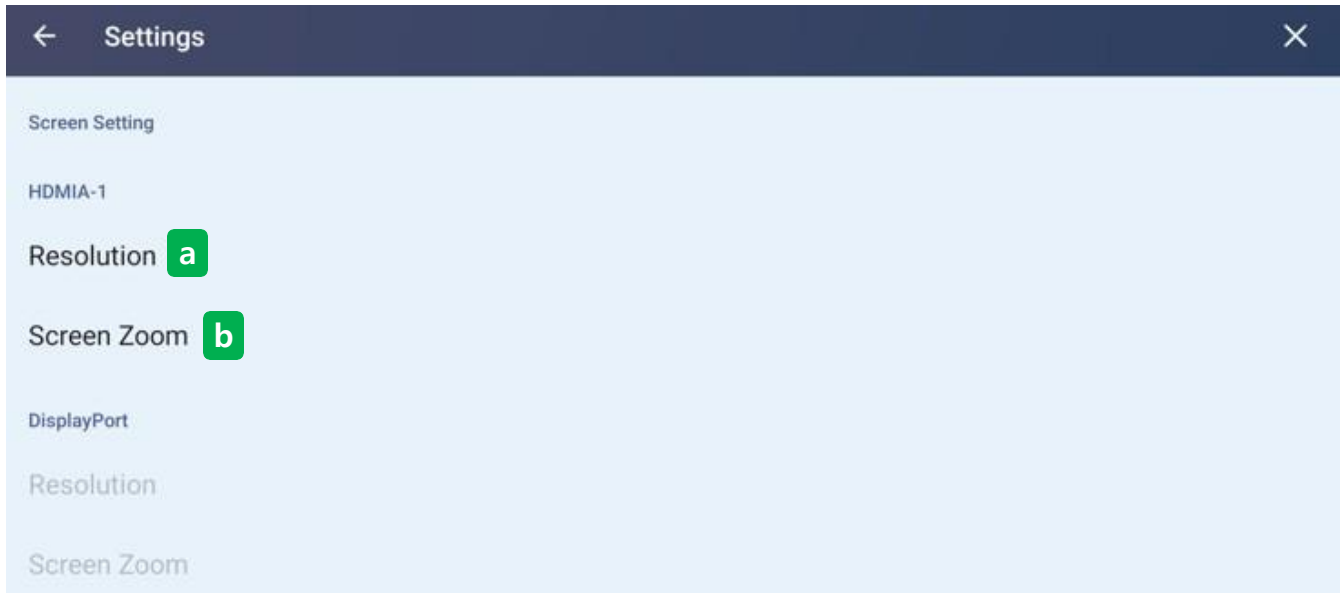

⑧ HDMI

- Resolution : The resolution output of HDMI and Type-C OUT terminals can be set.
- Screen Zoom : Users can zoom in or out of the screen connected by the HDMI, TPYE-COUT terminals.

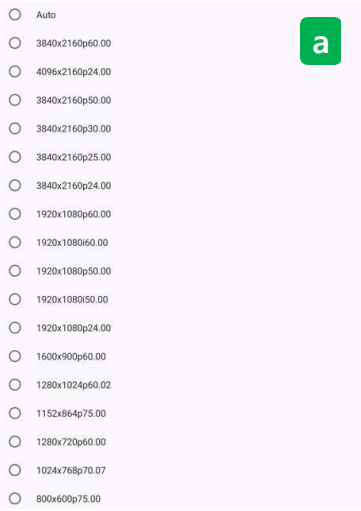

5.8 Display

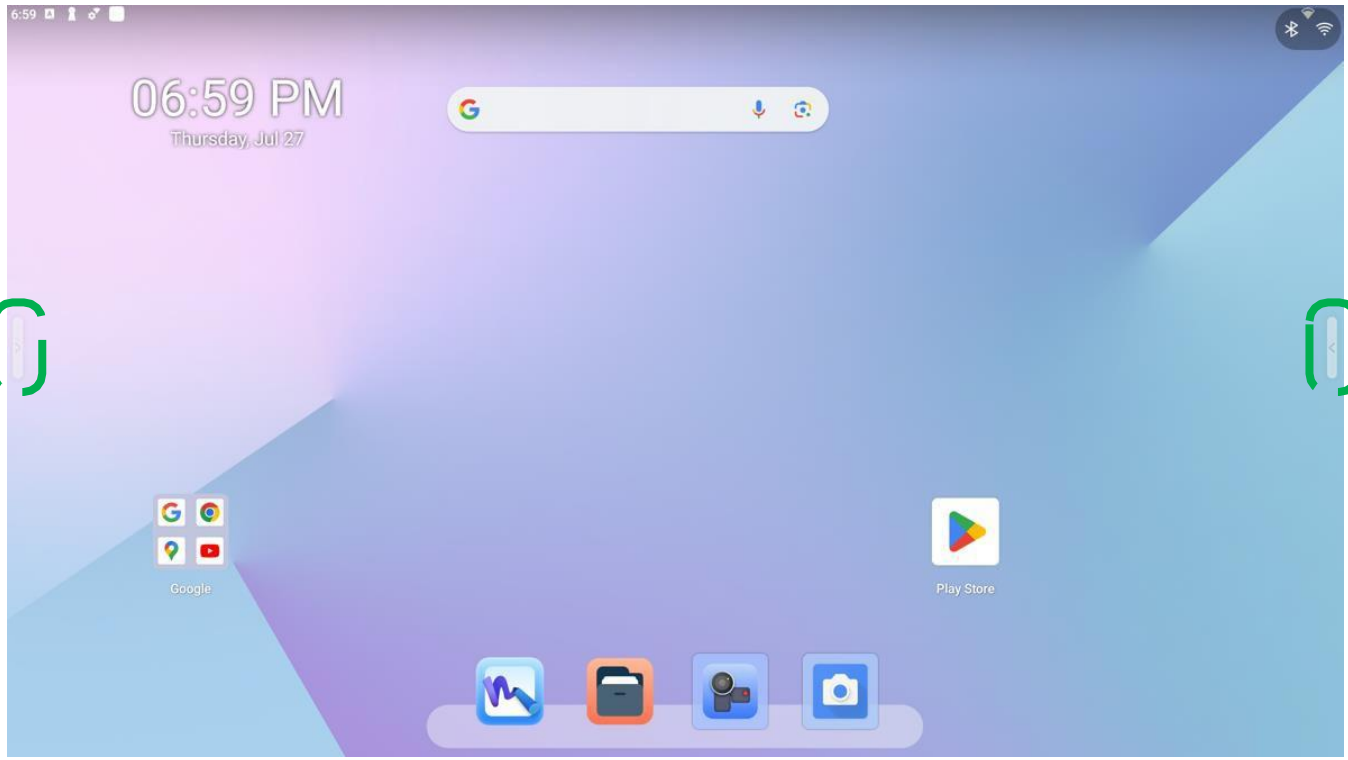

9 Side menu

- When the function is turned on, the Menu Bar appears on the left and right sides of the screen.
- Please refer to the Side Menu menu for detailed features in Side Menu.

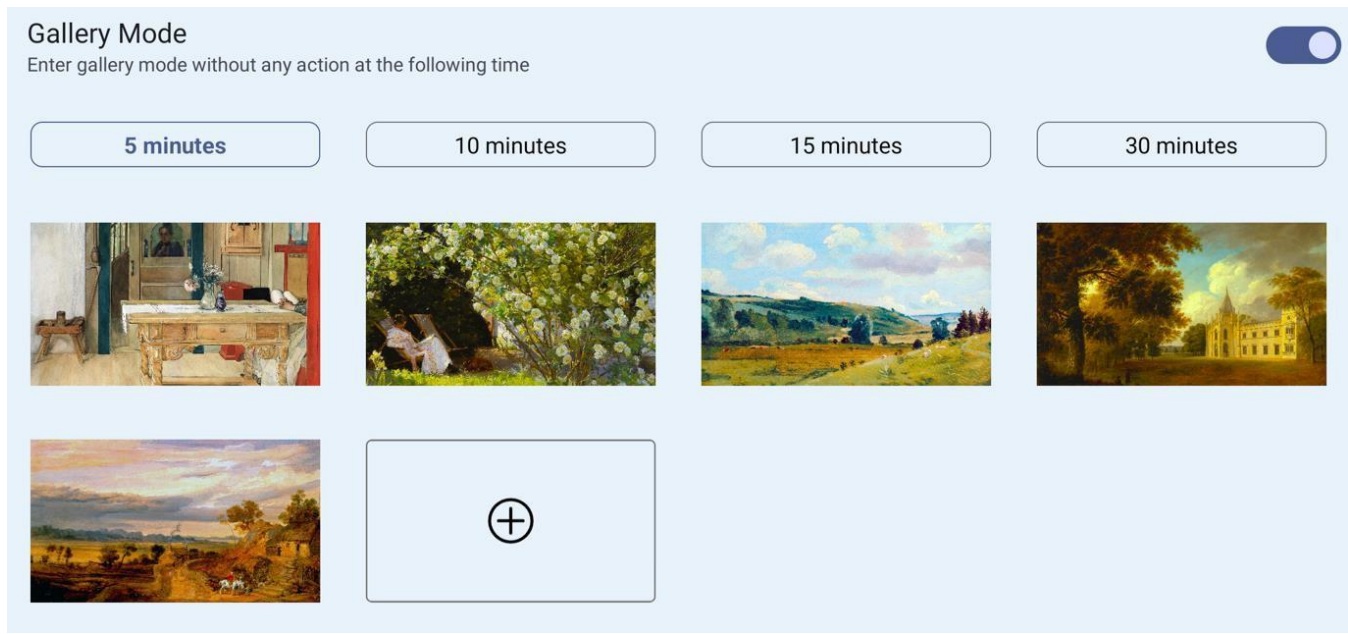

10 Gallery Mode

- The device's screen is replaced with a preset photo at a set time.

5.8 Display

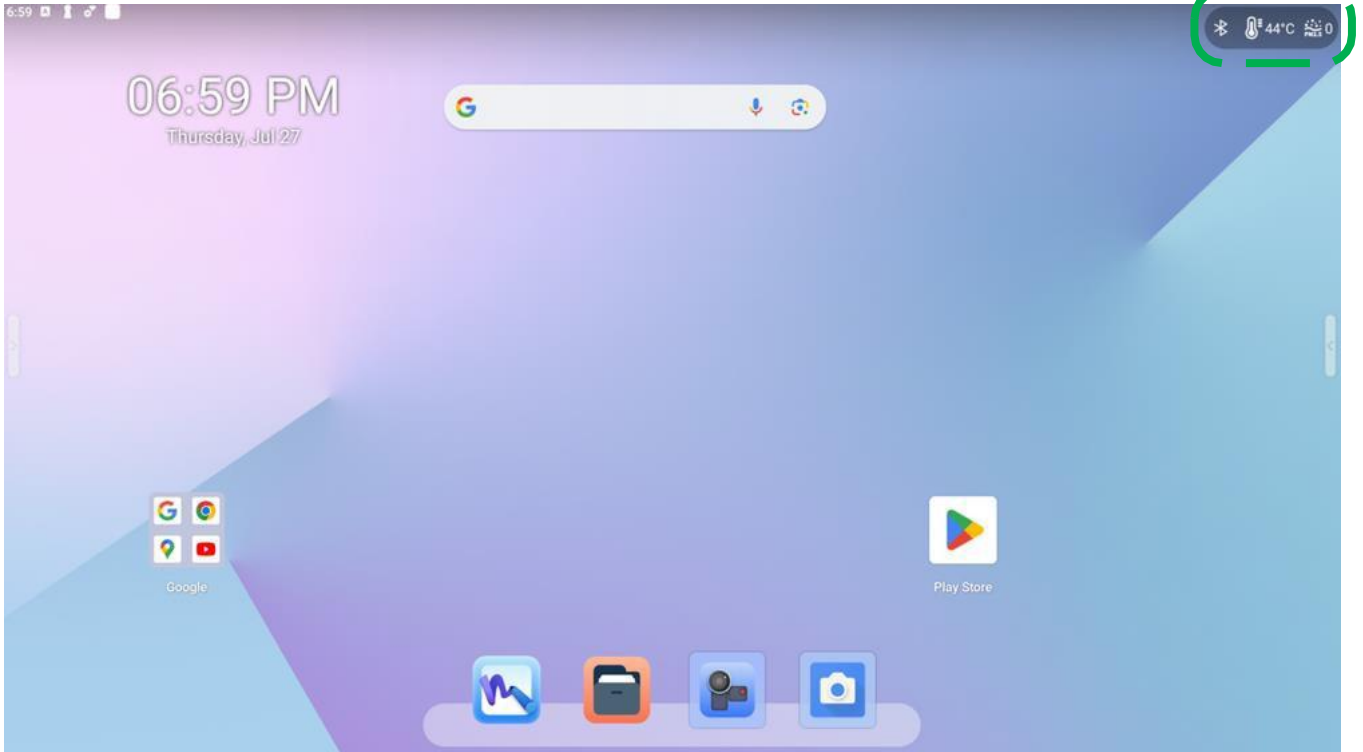

⑪ Temperature display

- When this function is turned on, the electronic board temperature is displayed at the top right of the Home screen.

5.9 Wallpaper & style

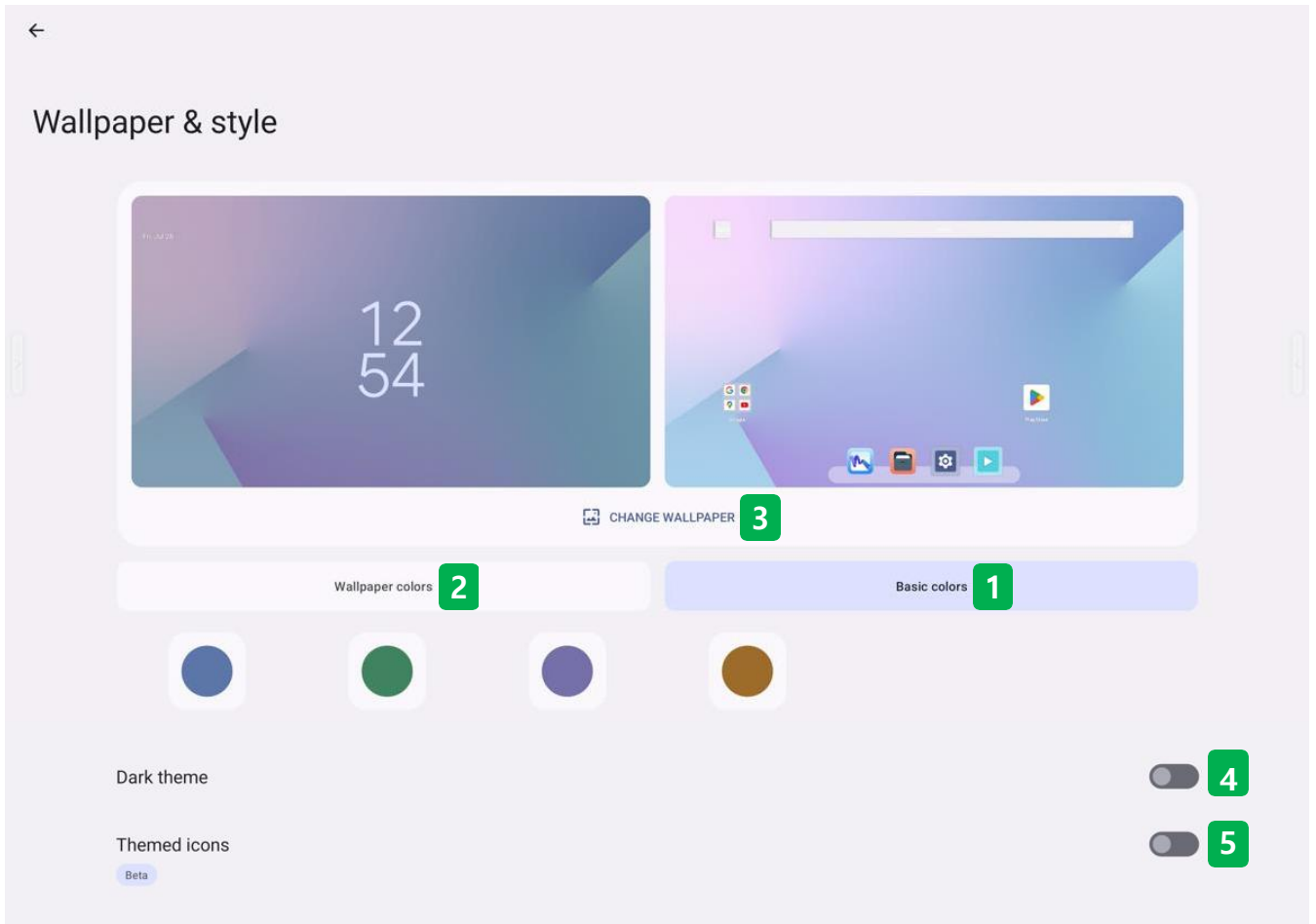

❖ Wallpaper

- Users can set the wallpaper of the Android Home screen and the lock screen.

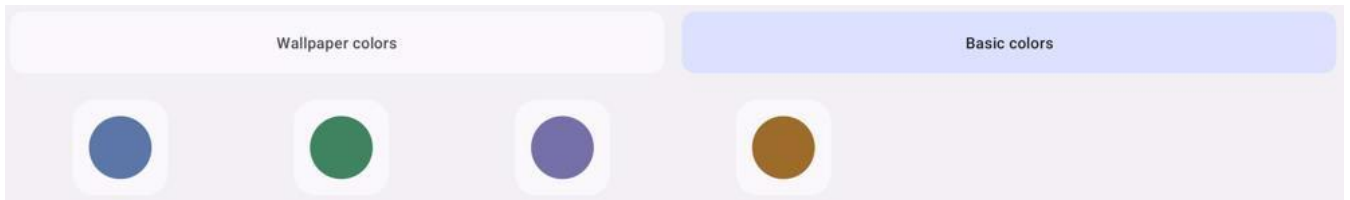

① Basic colors

- Change the Android UI color array to the default monochrome structure.

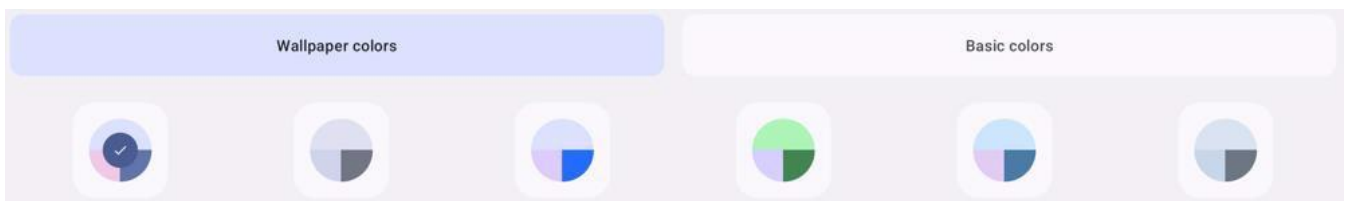

② Wallpaper colors

- Change the Android UI color array to a three-color structure.

5.9 Wallpaper & style

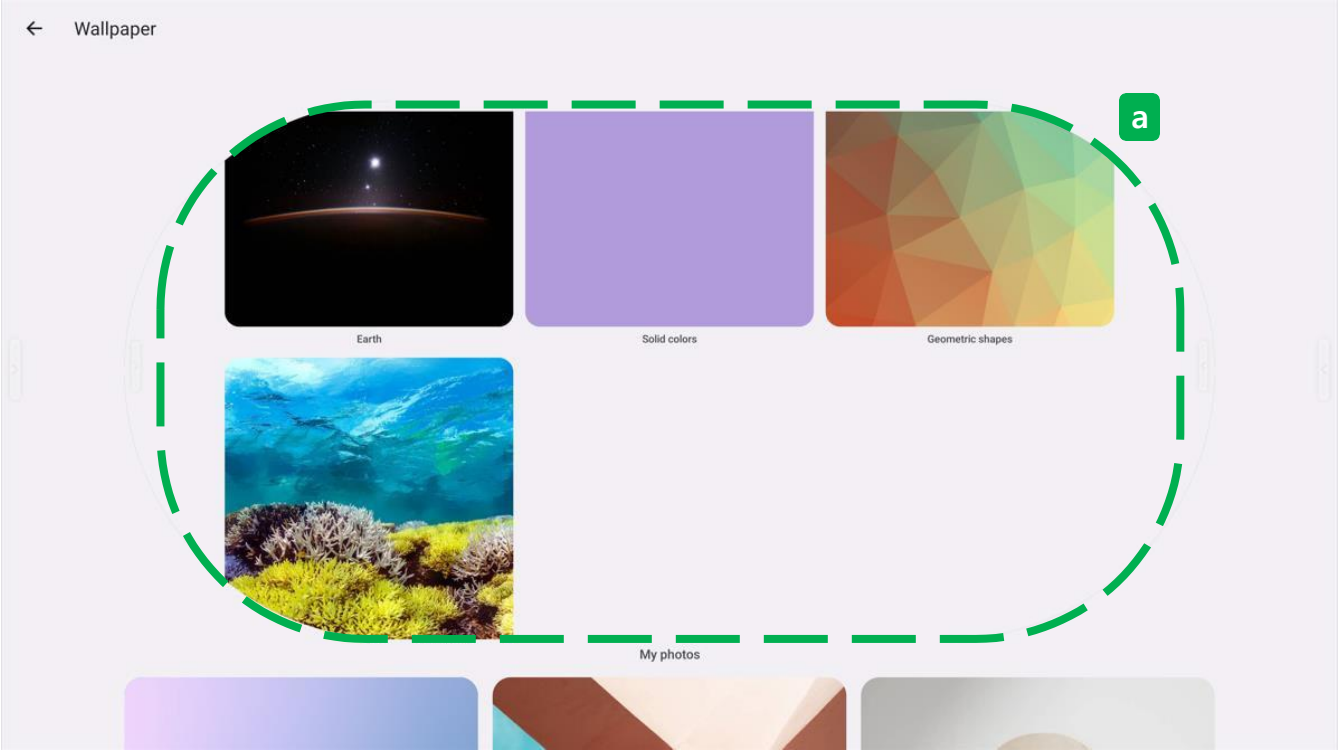

3 Change wallpaper

- When clicking the change wallpaper menu, users can change by selecting an image that supports the system by default.
- On-device wallpapers, cityscapes, Life, Textures, Landscapes, Art, Earth, Solid colors, Geometric shapes, and the Seascapes menu, each of which supports 3840 * 2160 resolution.

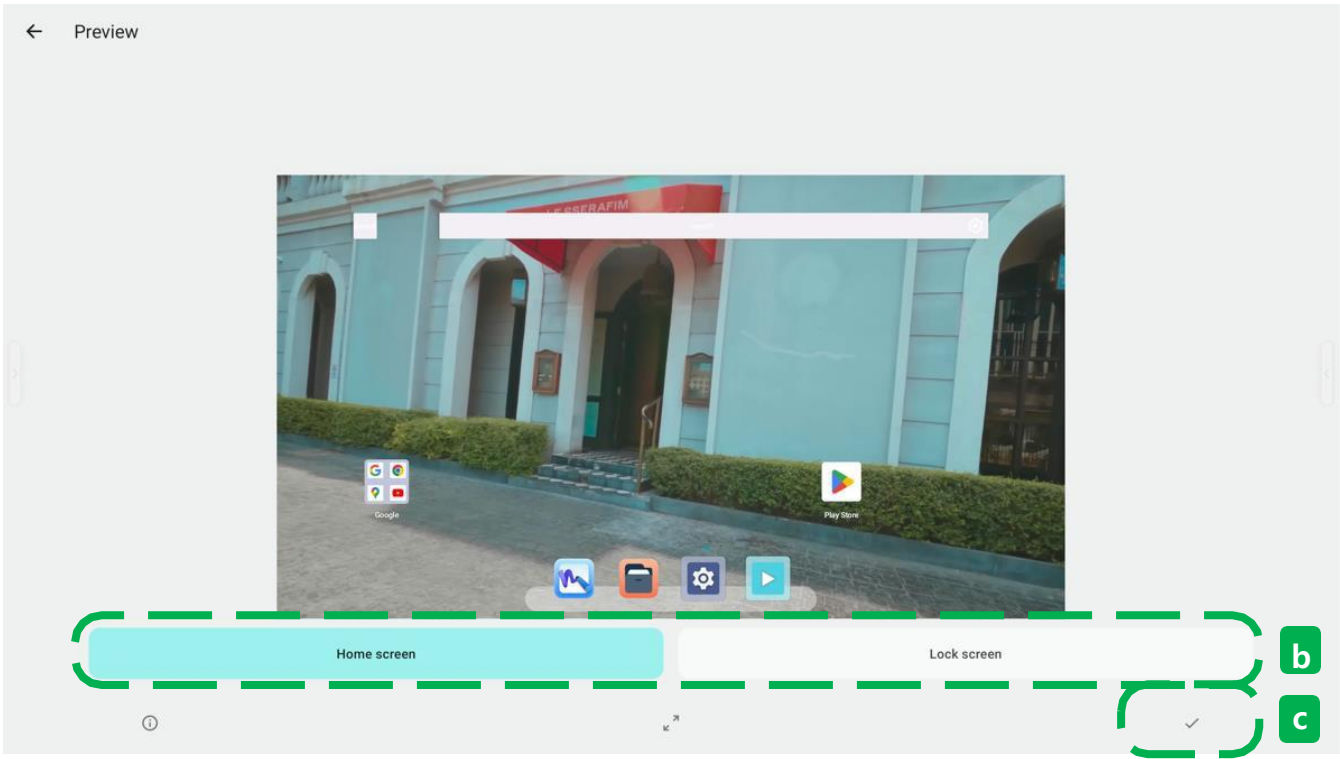

a Select a photo

- Users can select and add any image you want in addition to the default image by selecting the area in the check box.

5.9 Wallpaper & style

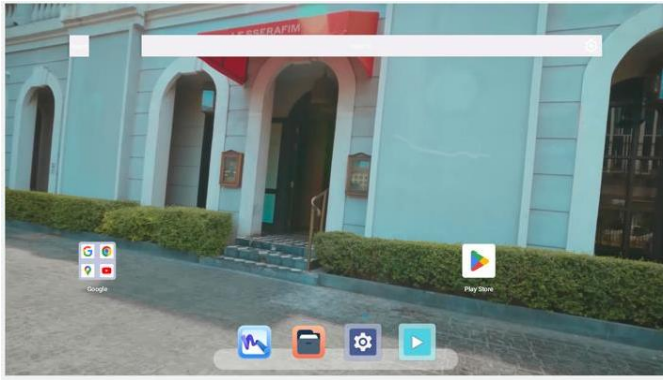

Home screen



Lock screen

ⓑ Home screen & lock screen

- Users can check the HOME Screen and Lock Screen status of the wallpaper want to change.

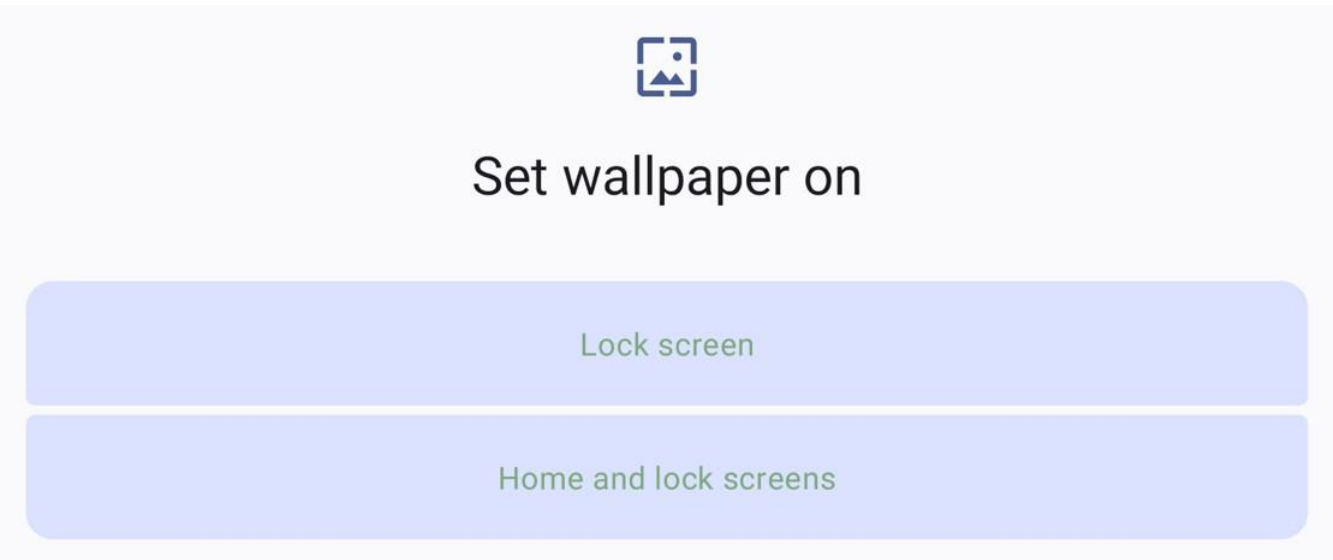

ⓒ Select

- Select that area to change the wallpaper.
- In the additional window, users can change the wallpaper of the desired part by selecting three types: Home screen, Lock screen, and Home and lock screen.

5.9 Wallpaper & style

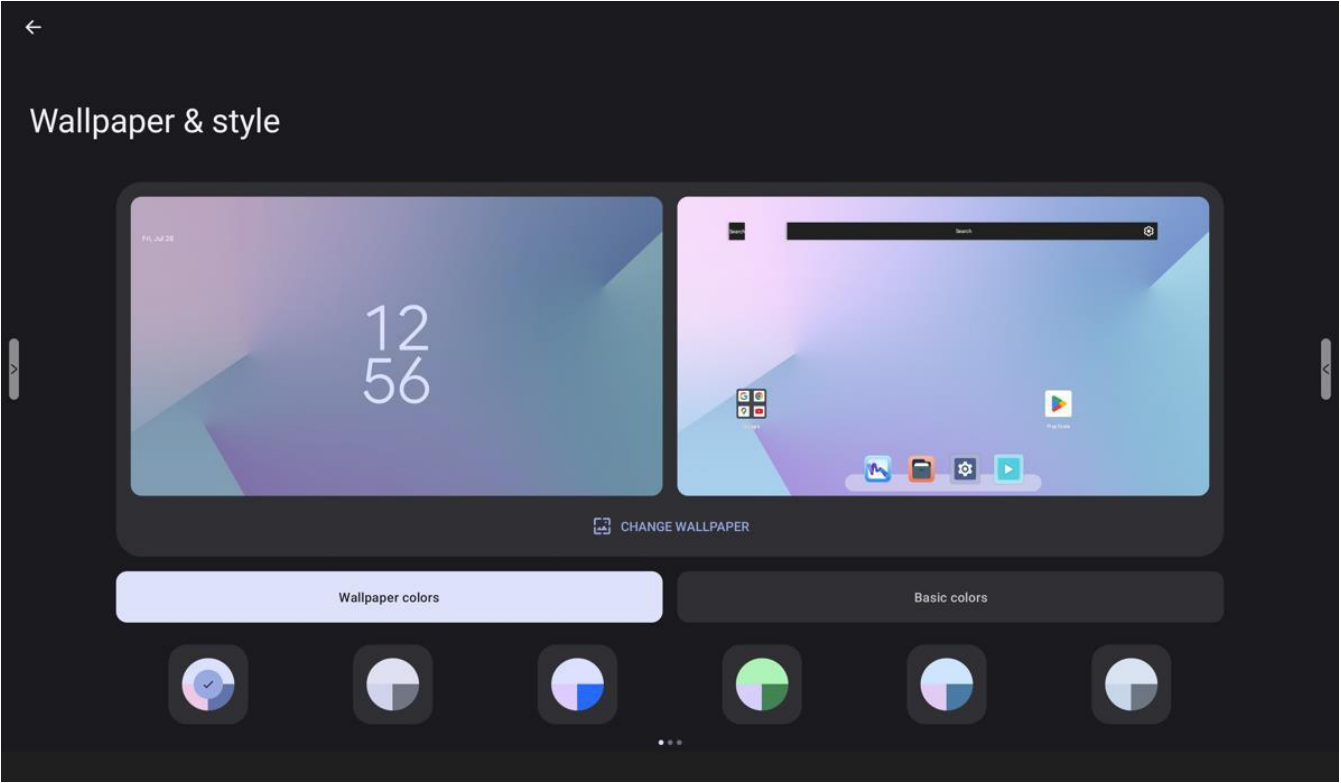

④ Dark theme

- Using a dark theme changes the Android UI to a darker color overall.



⑤ Themed icons (Beta)

- The Theme ICONS function changes the icon color of the app in Android.
- This feature may still be changed later to the BETA version.

5.10 Accessibility

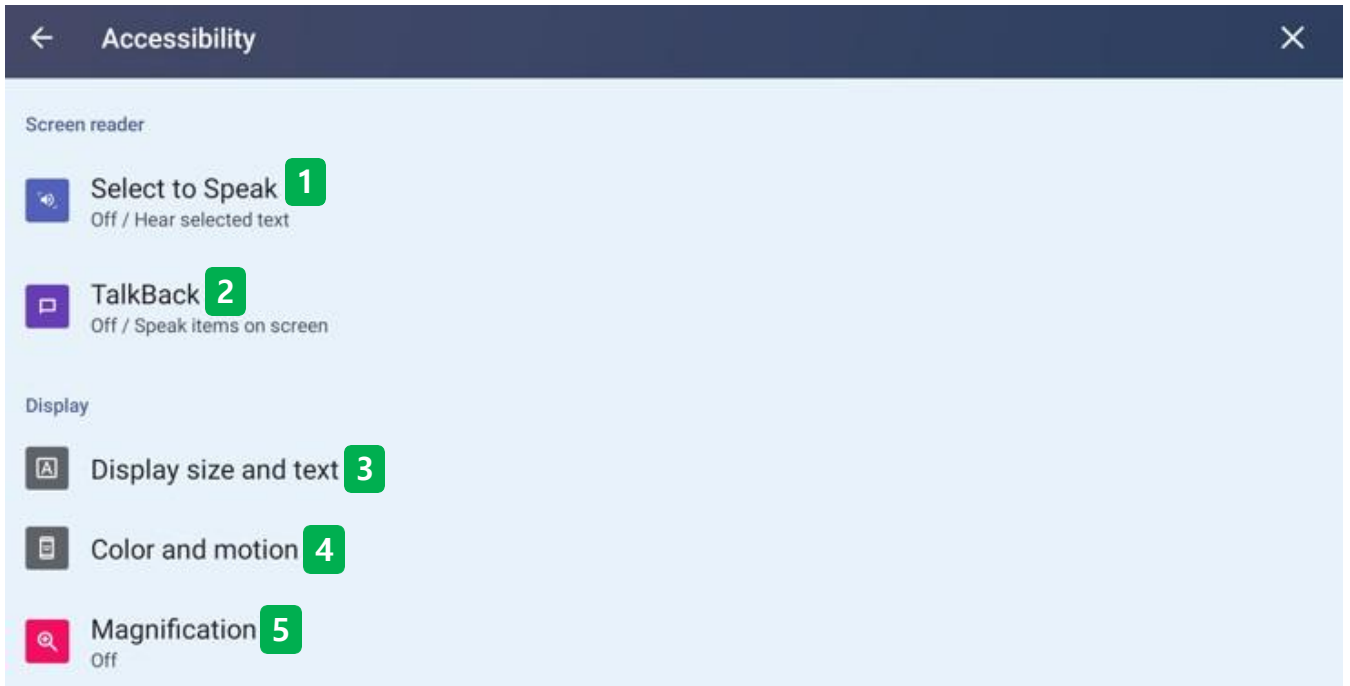

❖ Accessibility

- The accessibility menu can be set up to enhance convenience in using IFPD.

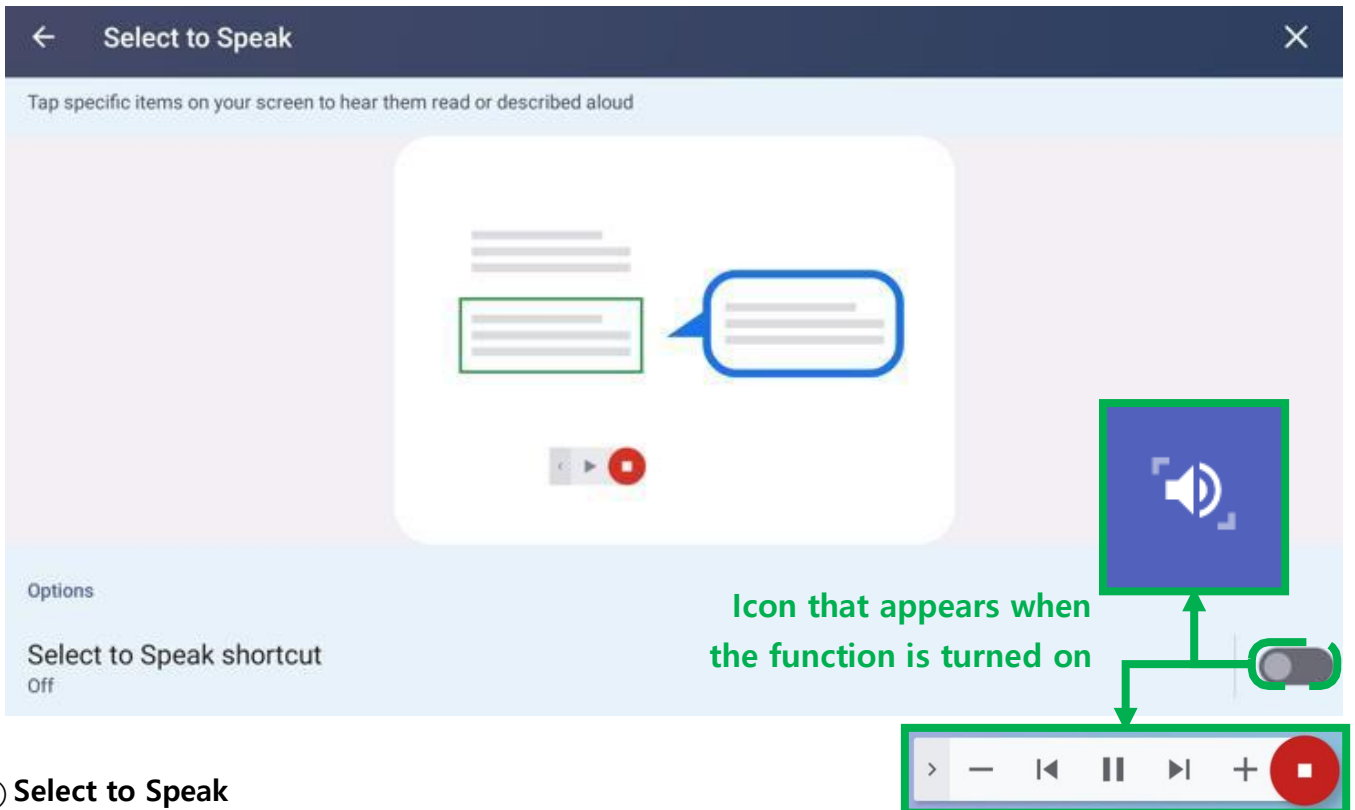

① Select to Speak

- Tap a specific menu on the screen to read or explain the contents aloud.
- When you turn on the feature, a small speaker-shaped icon appears on the right side of the screen, and a play button appears when you click on the speaker icon.

When you start playing in this state, read the selected menu aloud on the screen of IFPD.

5.10 Accessibility



Allow Select to Speak to have full control of your device?

Full control is appropriate for apps that help you with accessibility needs, but not for most apps.

View and control screen

It can read all content on the screen and display content over other apps.

View and perform actions

It can track your interactions with an app or a hardware sensor, and interact with apps on your behalf.

① Feature supplement descriptions

- It is recommended to give a perfect control to the app that provides access to accessibility, but it is not suitable for most Apps.
- Read all the content displayed on the screen and display the content on the other apps.
- Users can track your interactions with the App or hardware sensor and interact with the App on behalf of the user.

[How to use the select to speak feature]

1. Tap the menu, such as text or image.
2. To select multiple menus, drag the screen with fingers.
3. Tap the Play button to listen to all the menus displayed on the screen.
4. Select the text displayed in the camera view.

5.10 Accessibility

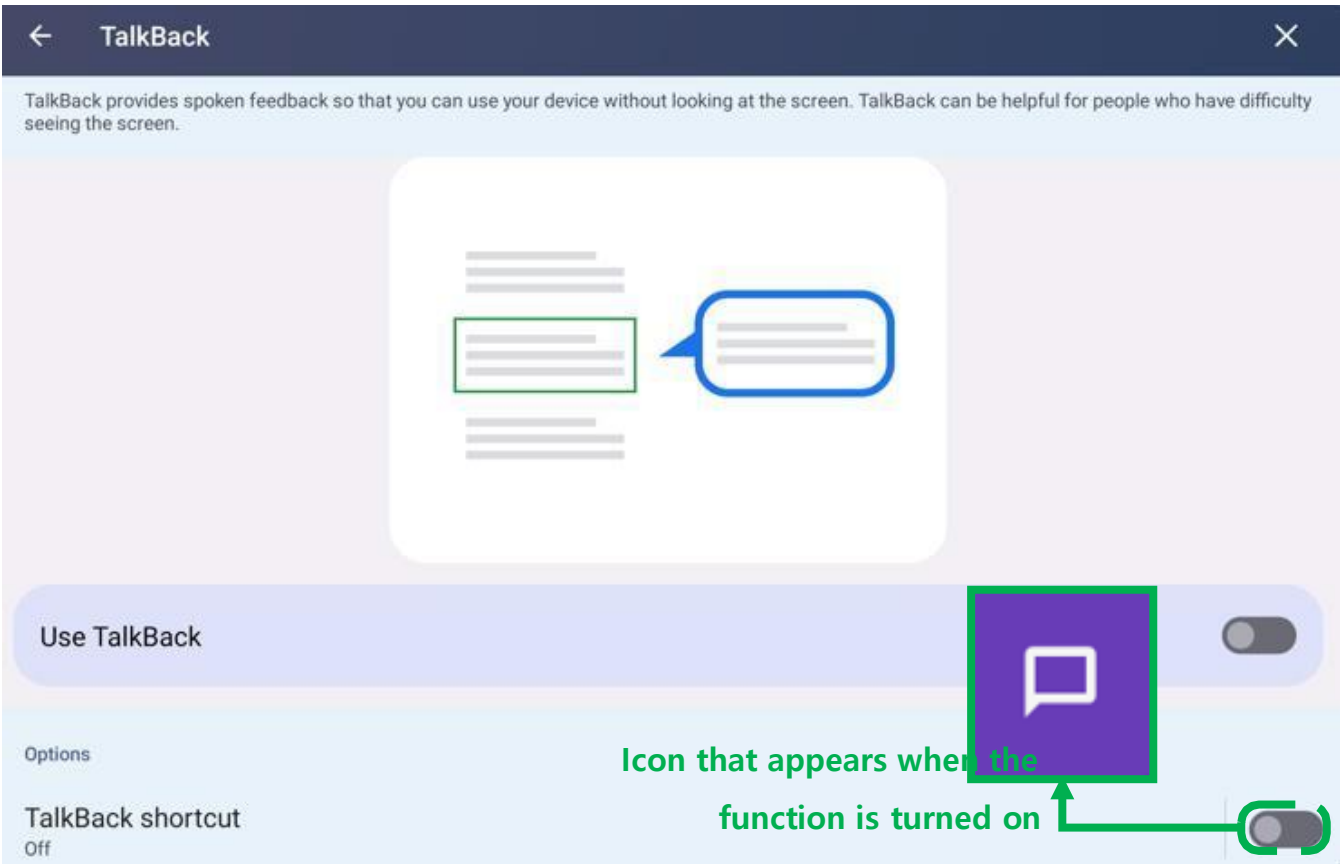

② TalkBack

- It provides voice feedback and users can use the device without looking at the screen. This feature can help users who are hard to see the screen.

① Feature supplement descriptions

- It is recommended to give a perfect control to the app that provides access to accessibility, but it is not suitable for most Apps.
- Read all the content displayed on the screen and display the content on the other apps.
- Users can track your interactions with the App or hardware sensor and interact with the App on behalf of the user.

5.10 Accessibility

① Feature supplement descriptions

[How to use the TalkBack feature]

- 1. Swipe to the right or left to move between several menus.
- 2. Double-tap the menu to activate it.
- 3. Drag with two fingers to scroll.

[How to stop using the Talkback feature]

- 1. Volume Key: Press 2 volume button for a few seconds at the same time.
- 2. set-up : Tap Enable TalkBack. The outline is displayed. Tap it twice.

When the confirmation message is displayed, tap the stop. The outline is displayed. Tap it twice.

Use accessibility button to open

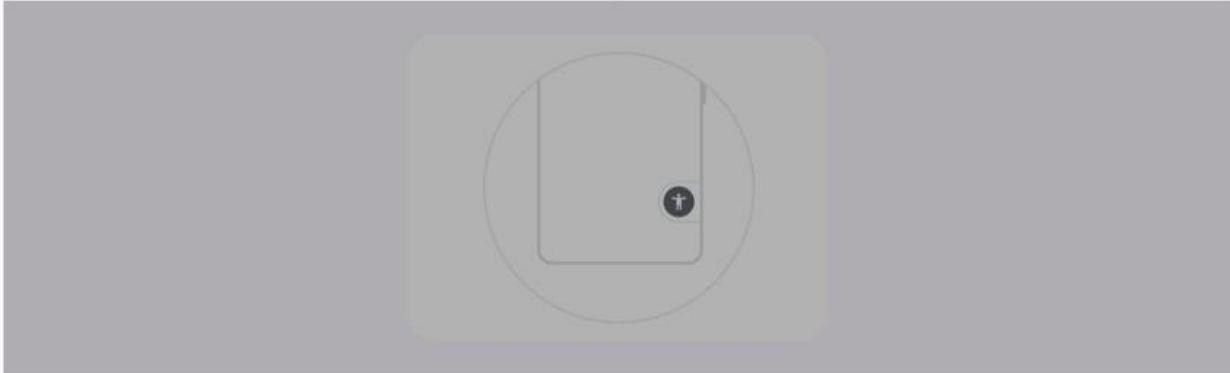

To use this feature, tap the accessibility button on your screen.

GOT IT

5.10 Accessibility

③ Display size and text

- This feature is the same as the description of the Display menu. Please refer to the Display page.

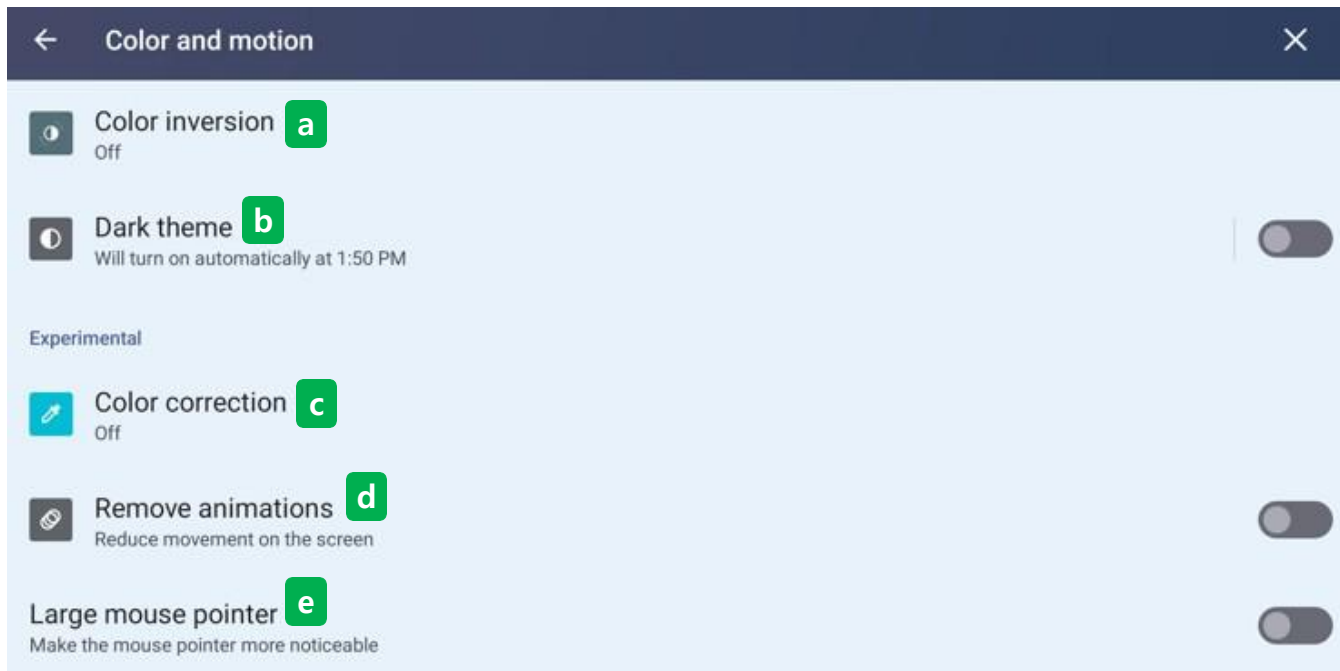

④ Color and motion

-Users can adjust the color users see on the Android screen or control the animation behavior.

Ⓐ Color inversion

- The color inversion function changes light colors to dark colors and dark colors to light colors.

Ⓑ Dark theme

- The Dark theme is the same as the Wallpaper setting, and changes the Android UI to an overall darker color.

- The details of the feature are the same as the Wallpaper menu. Please refer to the Wallpaper page.

Ⓒ Color correction

- Color correction functions are used to check the color more accurately or to remove colors to help users concentrate.

Ⓓ Remove animations

- Removes the animated UI on the Android screen to reduce screen movement.

Ⓔ Large mouse pointer

- Change the pointer size of the mouse connected to IFPD.

5.10 Accessibility

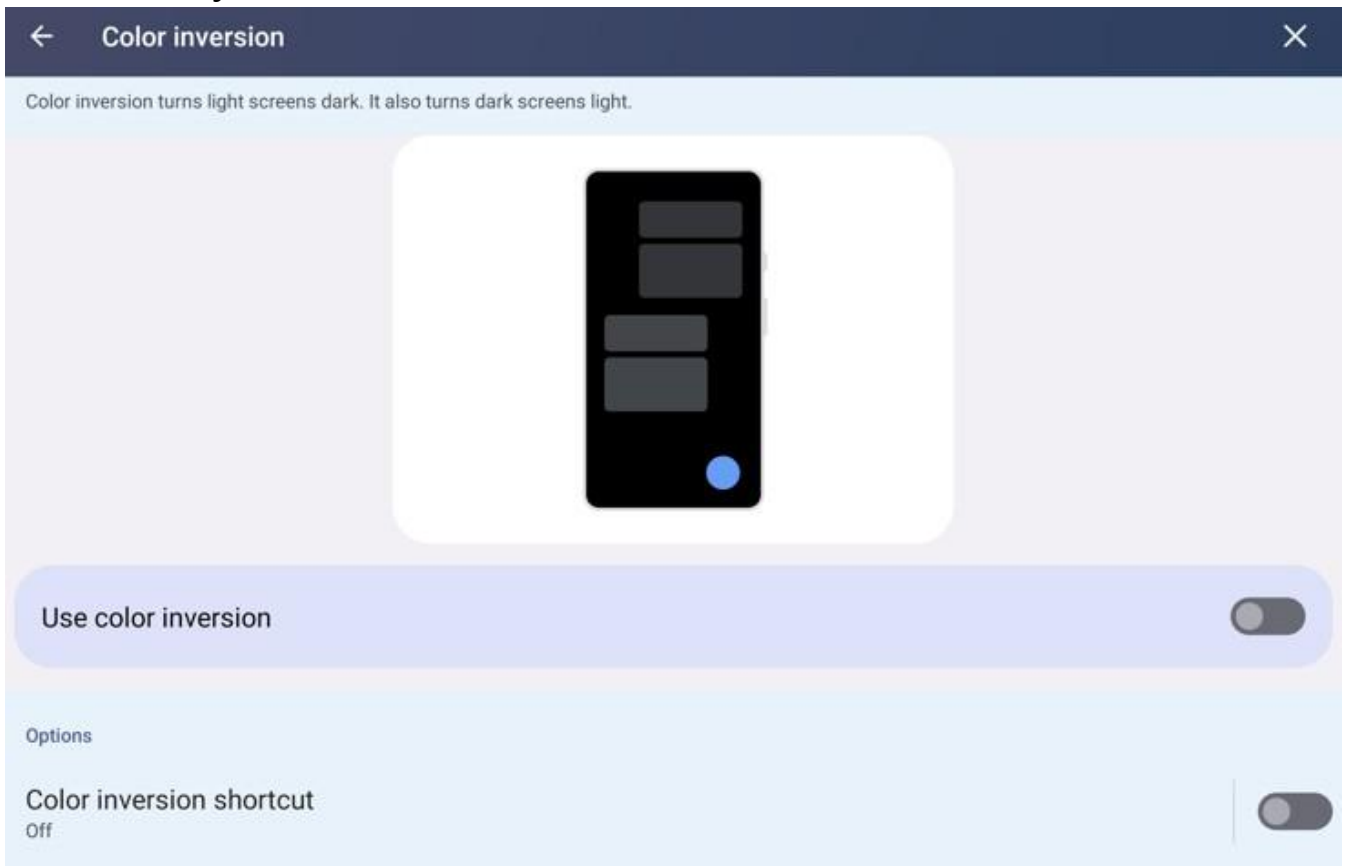

Ⓐ Color inversion

- The color inversion function changes light colors to dark colors and dark colors to light colors.

Ⓘ Feature supplement descriptions

- Colors change in media and images.
- Color inversion works in all apps.
- To display a dark background, a dark theme can be used instead.

5.10 Accessibility

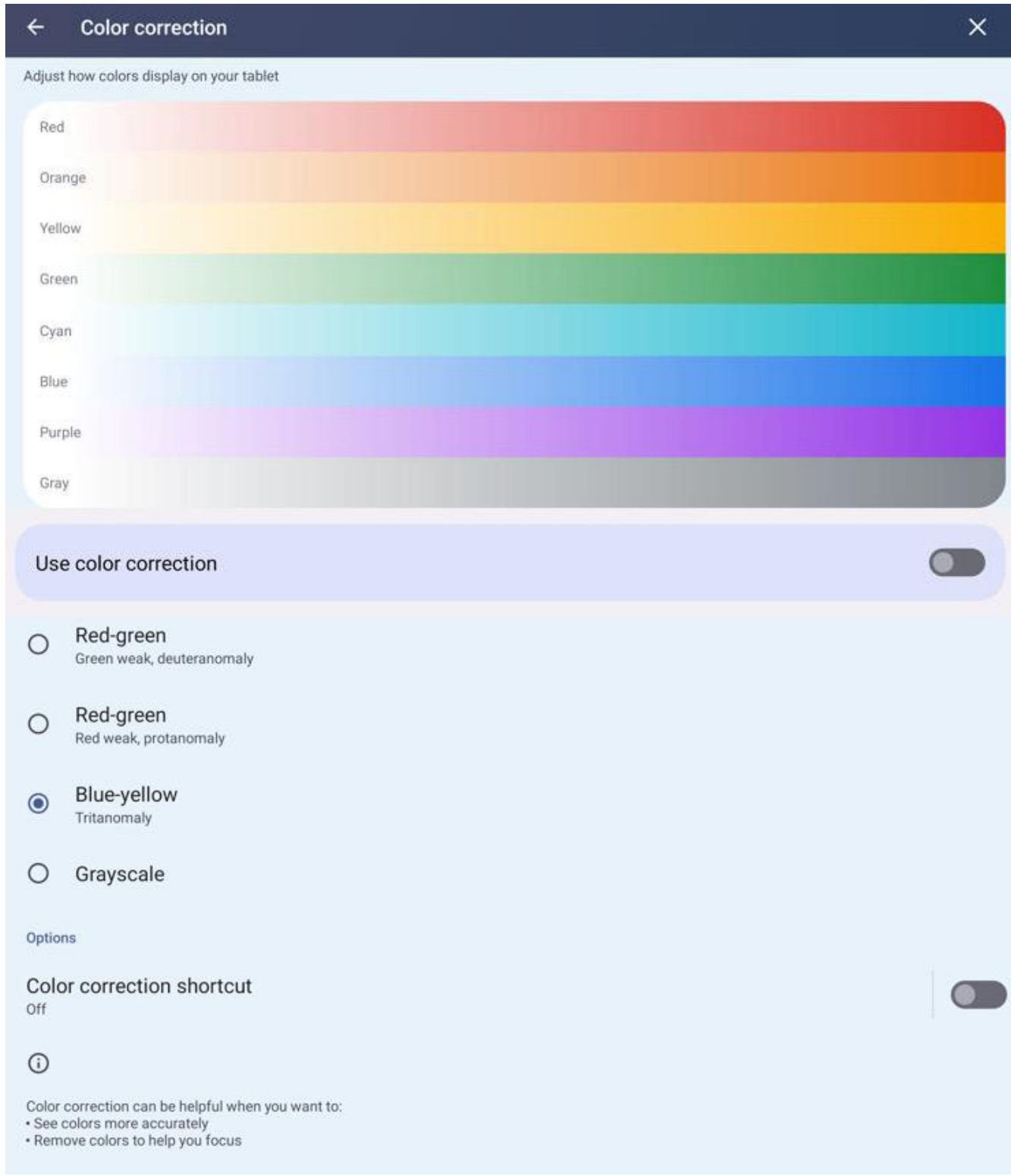

© Color correction

- Color correction functions are used to check the color more accurately or to remove colors to help users concentrate.

ⓘ Feature supplement descriptions

- Use to verify colors more accurately.
- Use to remove colors to help focus.

5.10 Accessibility

 **Remove animations**
Reduce movement on the screen

④ Remove animations

- Removes the animated UI on the Android screen to reduce screen movement.
- When turn on this function, all the movements that operate on Android will not change smoothly and change immediately.

Large mouse pointer
Make the mouse pointer more noticeable

⑤ Large mouse pointer

- Change the pointer size of the mouse connected to IFPD.



Large mouse pointer Off



Large mouse pointer On

5.10 Accessibility

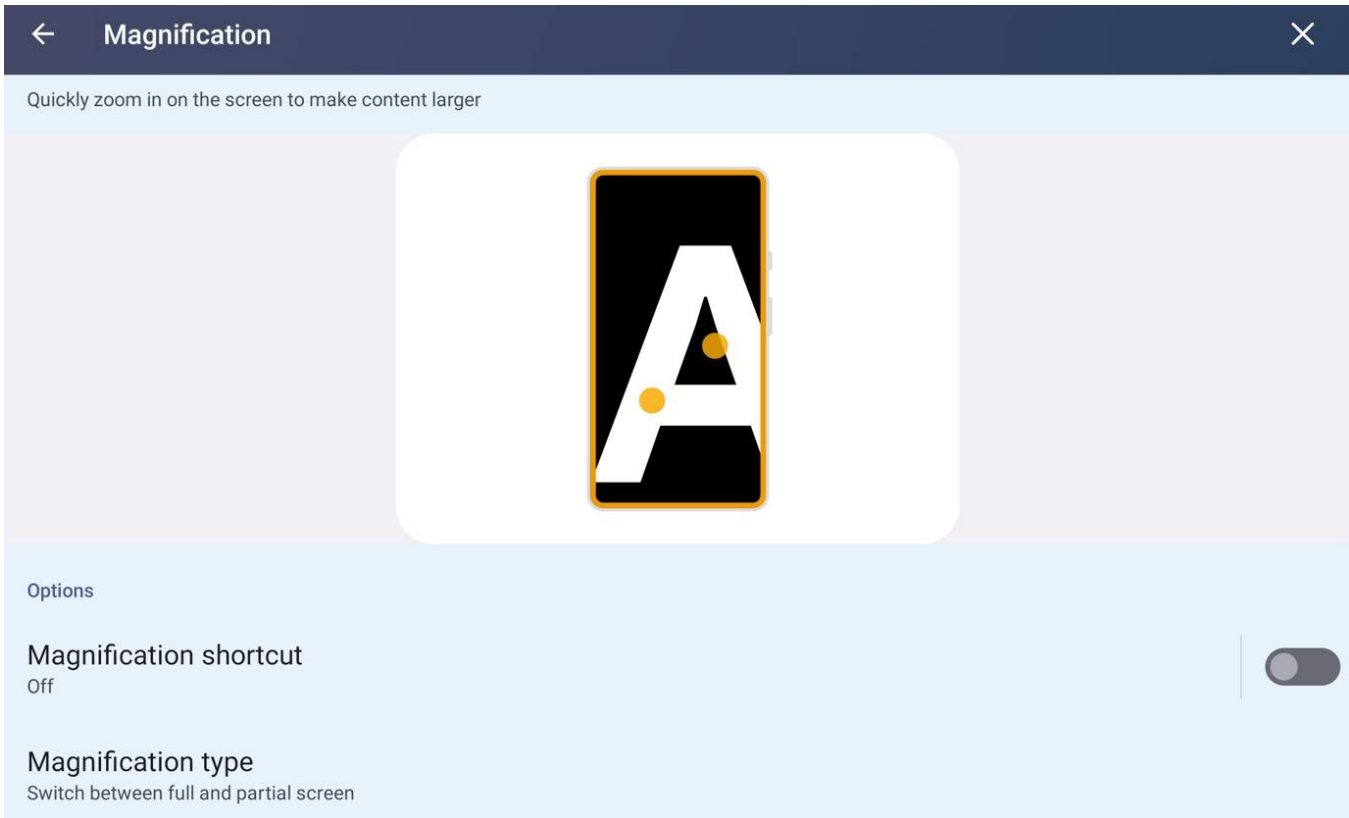

5 Magnification

- The zoom function is a feature that allows users to zoom in on the screen and display them in a separate window.

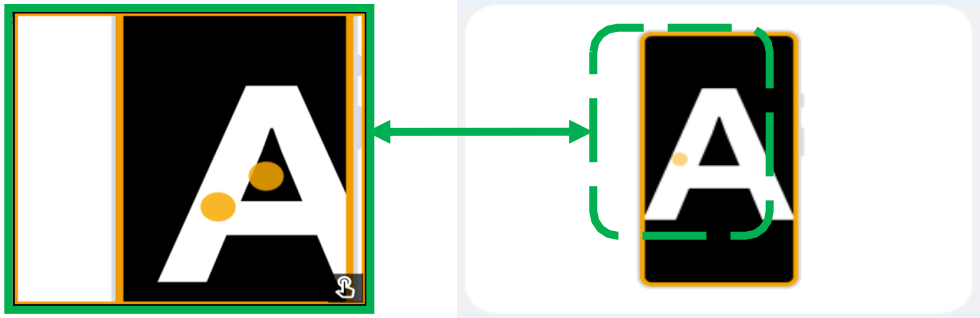

1 Feature supplement descriptions

[How to zoom in]

1. Use hotkeys to start zooming in.
2. Tap the screen.
3. Drag two fingers to move around the screen
4. To adjust the zoom in/out, open and close two fingers.
5. Use hotkeys to stop zooming in.

[How to temporarily zoom in]

1. Make sure that the zoom type is set to Full Screen.
2. Use the hotkeys to start zooming.
3. Touch and hold anywhere on the screen.
4. Drag two fingers to move around the screen
5. Release your finger to stop zooming in.

5.10 Accessibility

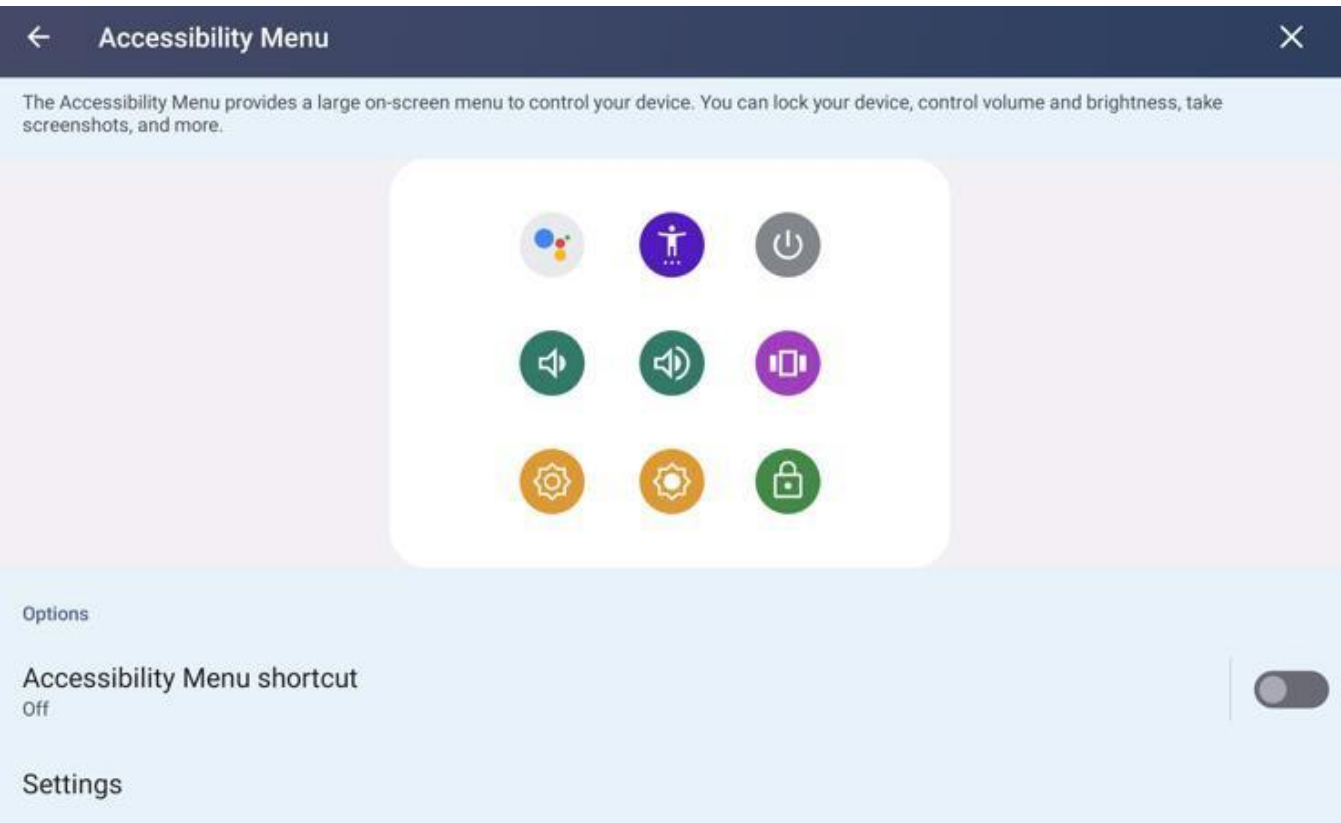
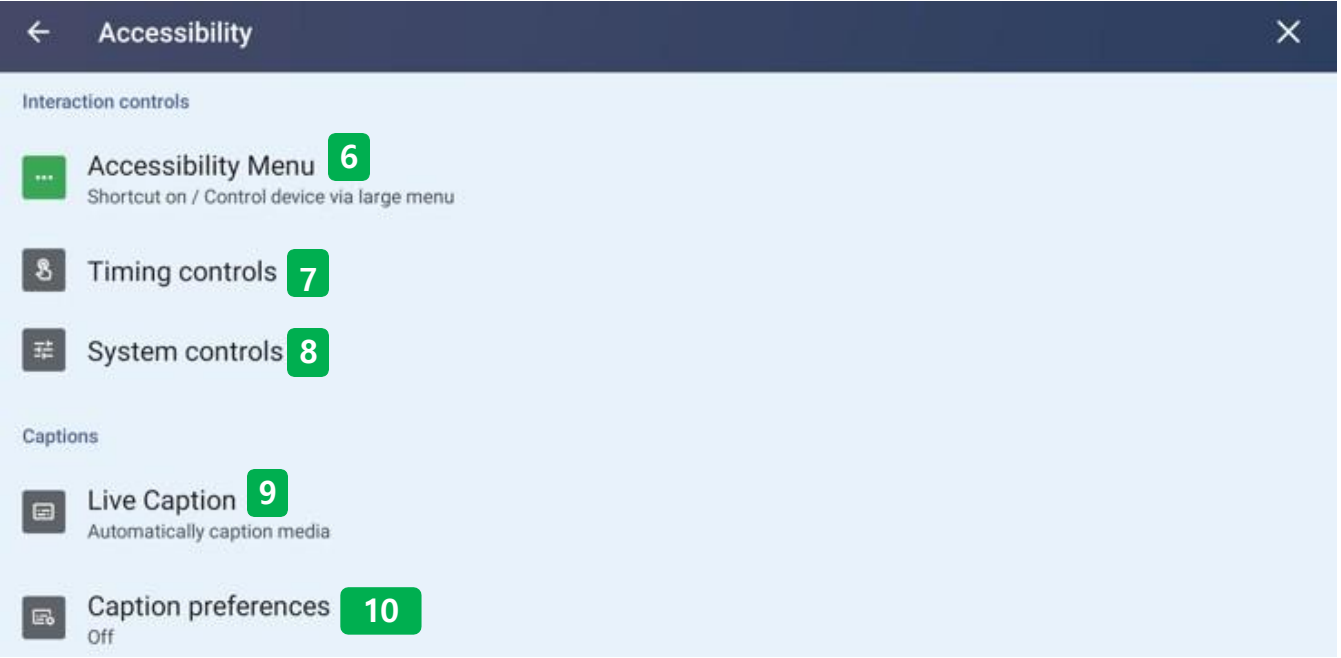

⑥ Accessibility Menu

- The Accessibility menu allows users to control your device with a menu that appears large on the screen.
- Tasks such as device lock, volume and brightness control, and screenshot are supported.

5.10 Accessibility

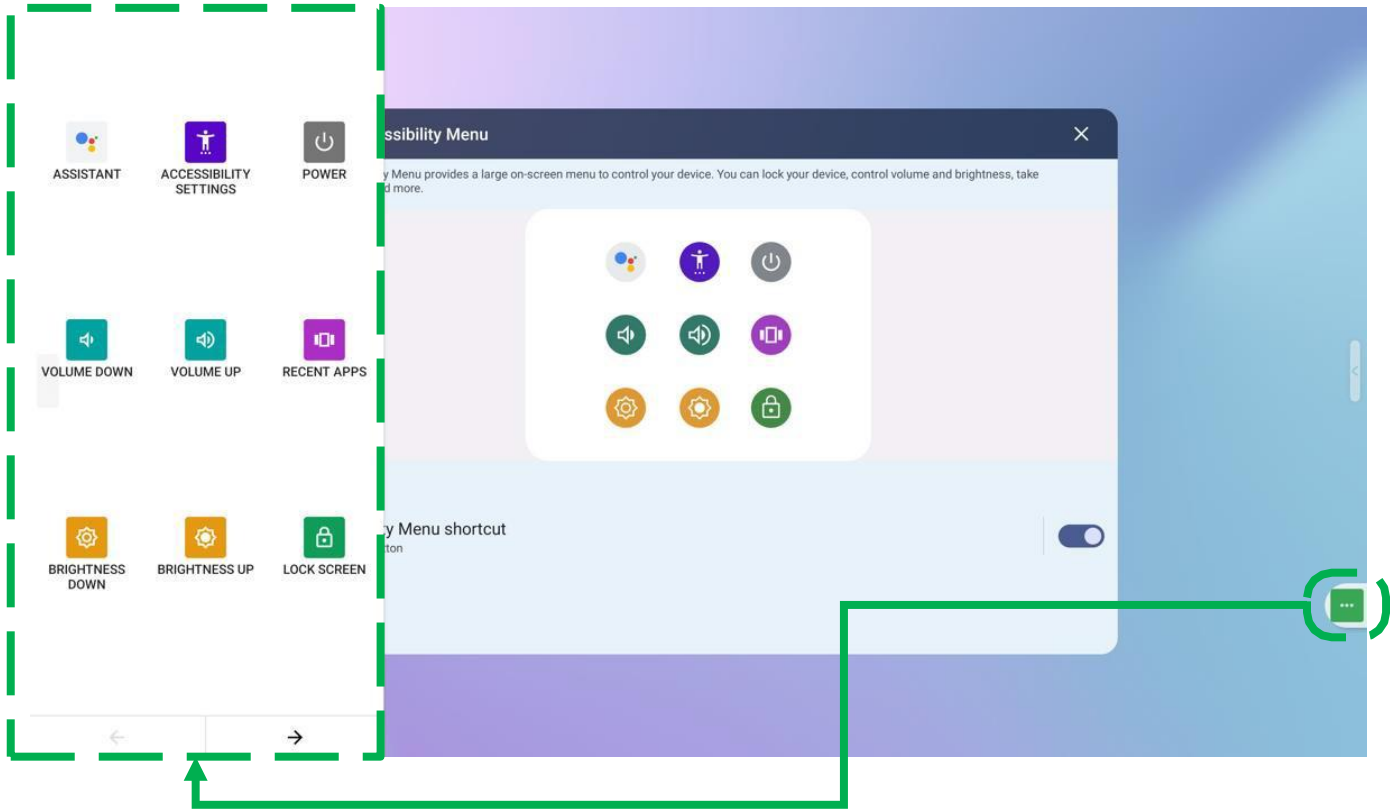

⑥ Accessibility Menu

- When turn on the feature, the accessibility menu icon appears on the right, and when you select the icon, the menu appears on the left.
- This menu makes it easy and fast to run features such as brightness, volume, power, lock, notification, and screenshots etc.

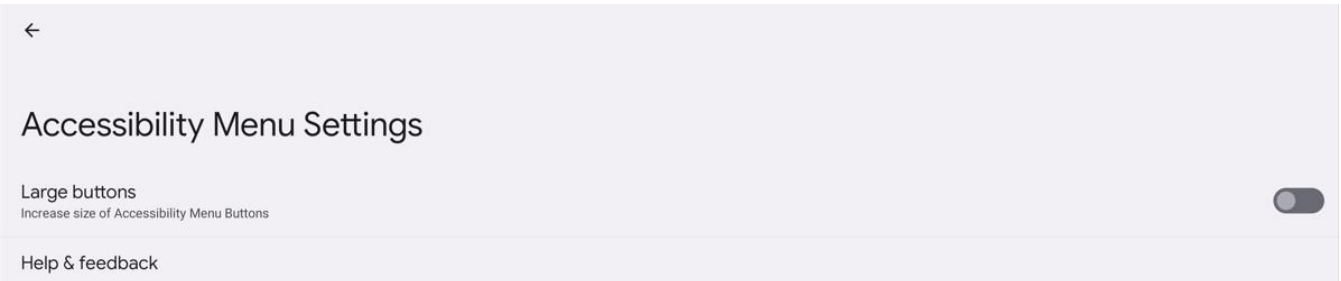

⑥ Accessibility Menu

- In the detail settings, users can change the icon size of the accessibility menu to make it larger.

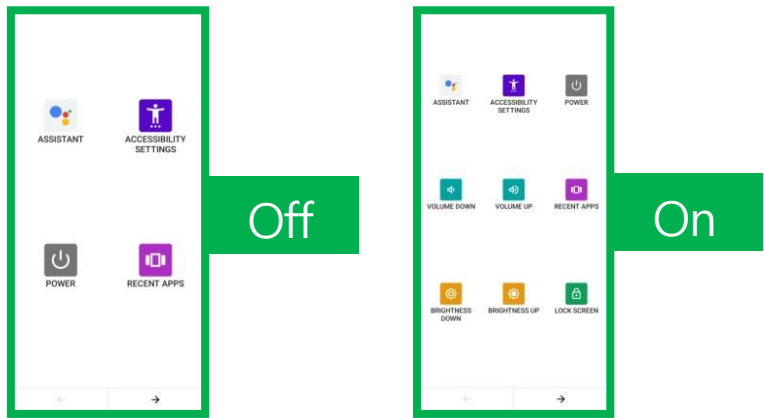

5.10 Accessibility

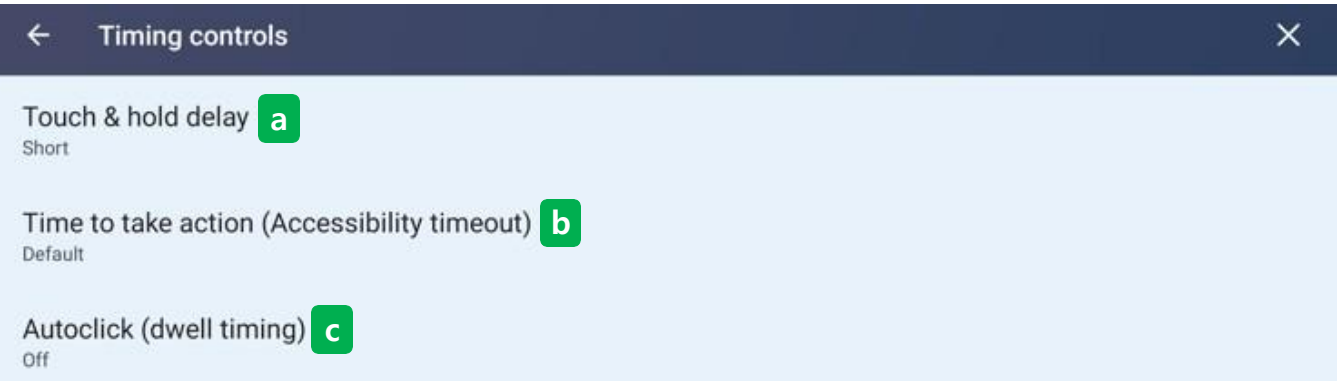

⑦ Timing controls

- The timing control function controls long-pressing touch, time to take action, and automatic clicking mouse.
- Timing preferences are not supported on all apps.

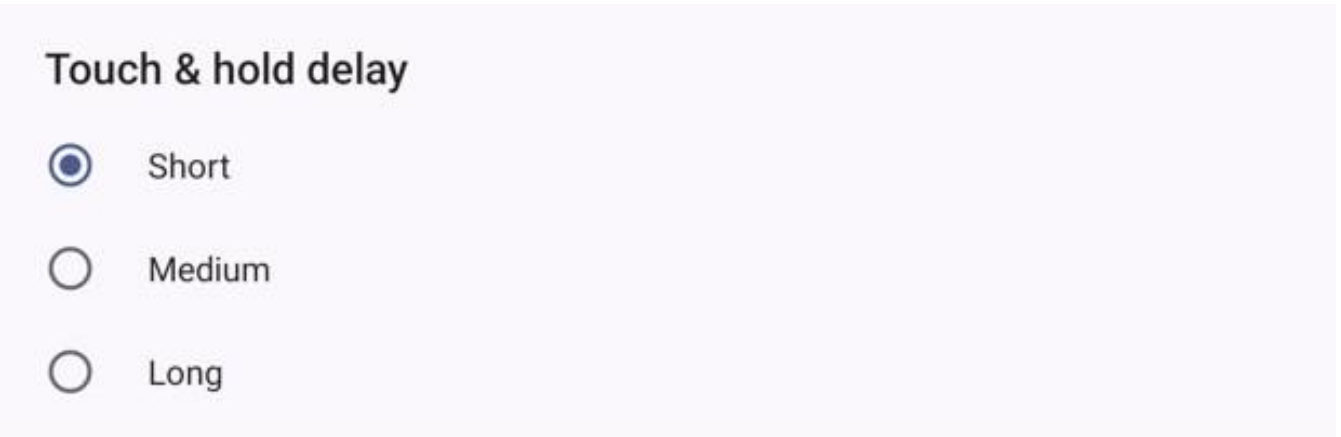

⑧ Touch & hold delay

- Users can select the delay time of the functions that operate by pressing the touch long in three steps: short, medium, and long.

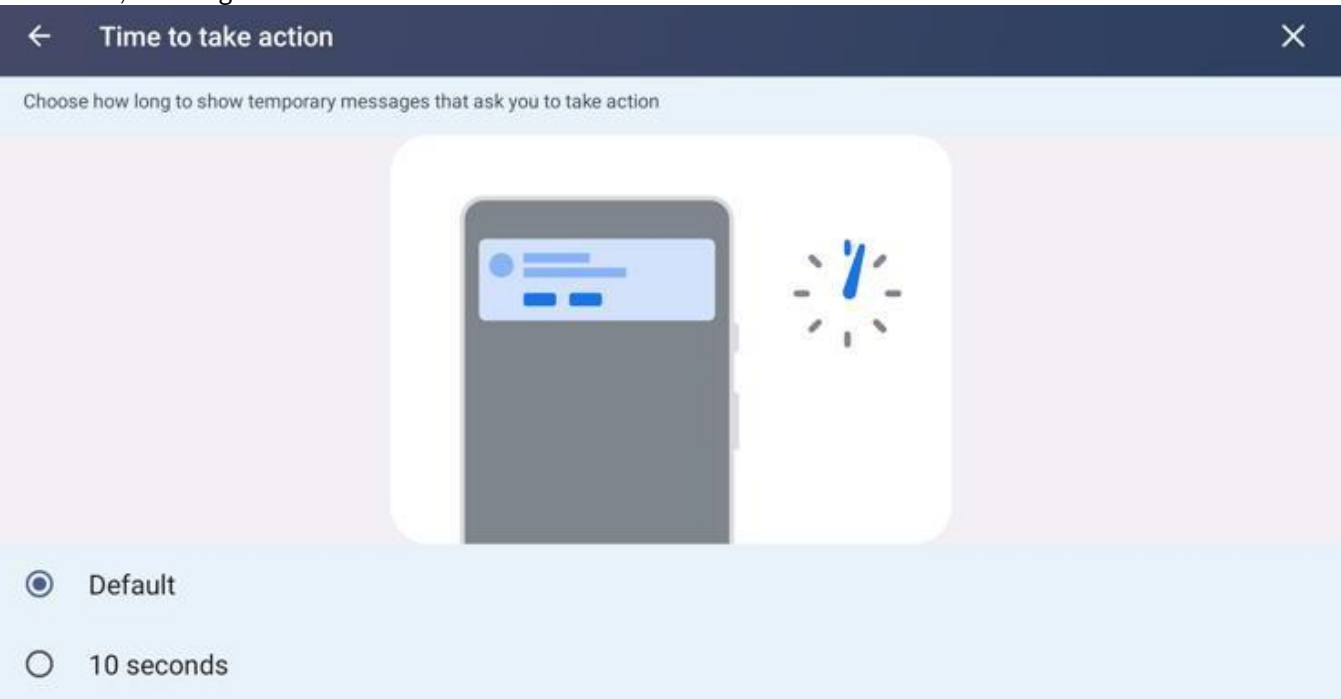

⑨ Time to take action (Accessibility timeout)

- Select the time at which users are prompted to take action.
- Users can set it to default, 10 sec, 30 sec, 1 min, 2 min.

5.10 Accessibility

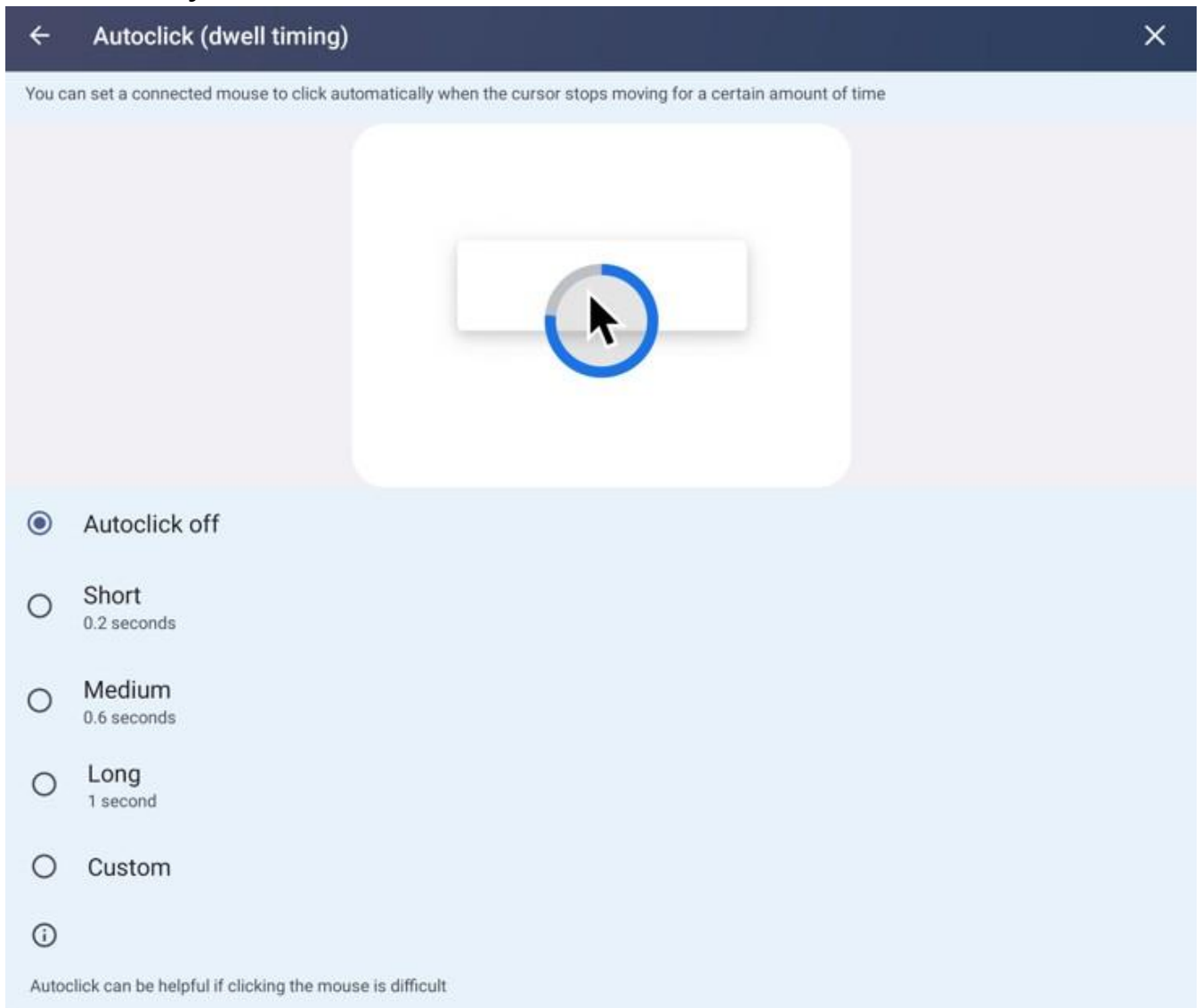

© Auto click (dwell timing)

- If the cursor stops the movement for a certain time, users can set the connected mouse to automatically click.
- Users can choose Not to use, 0.2 sec, 0.6 sec, 1 sec, custom (0.2 sec to 1 sec).
- Automatic clicks can be useful when mouse clicks are difficult.

5.10 Accessibility

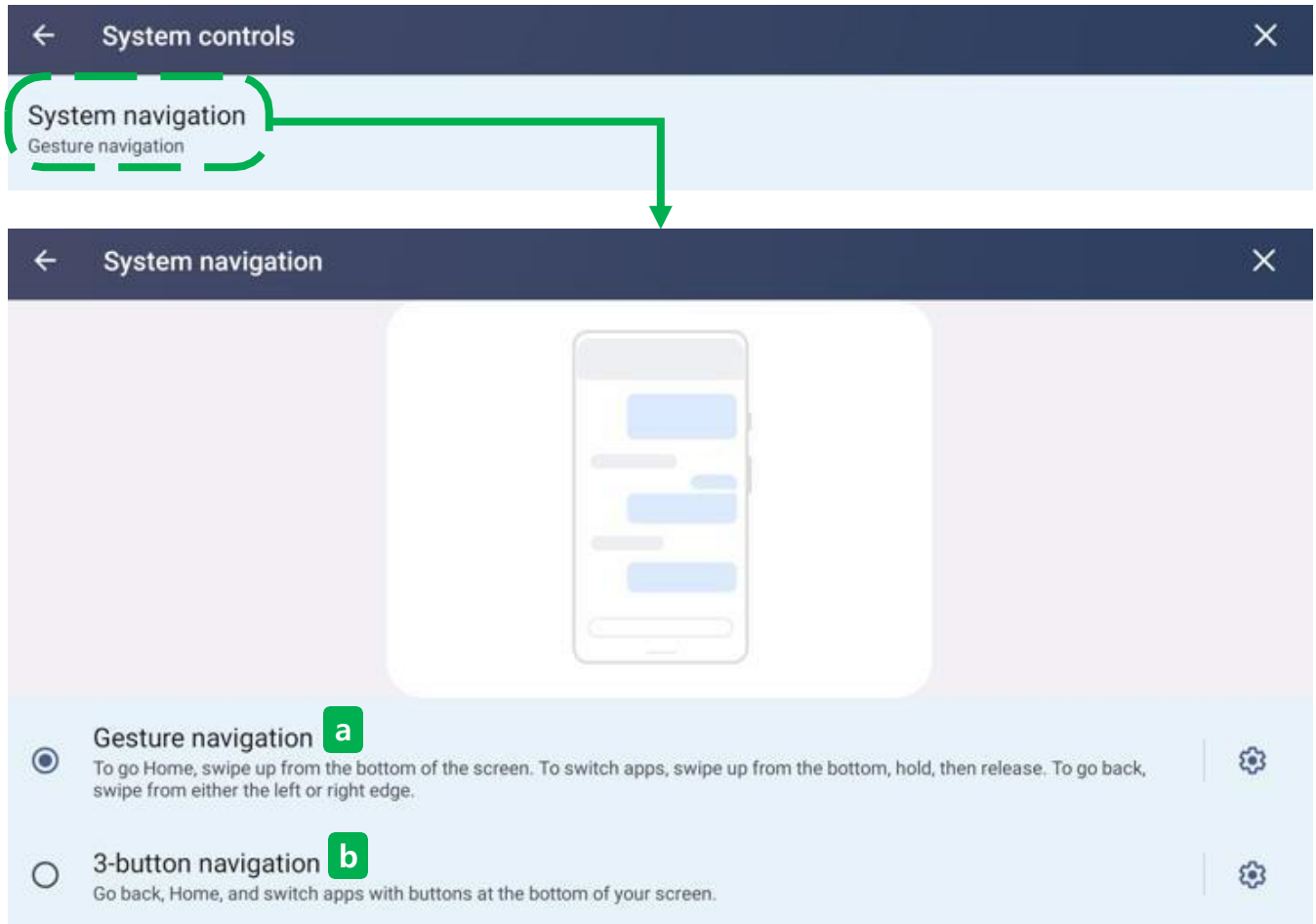

8 System controls

- The System Control feature sets up functions related to moving to the Home screen or switching to the App screen.



a Gesture navigation

- Users can use gestures to navigate to the Home screen, switch apps, and set sensitivity.

5.10 Accessibility

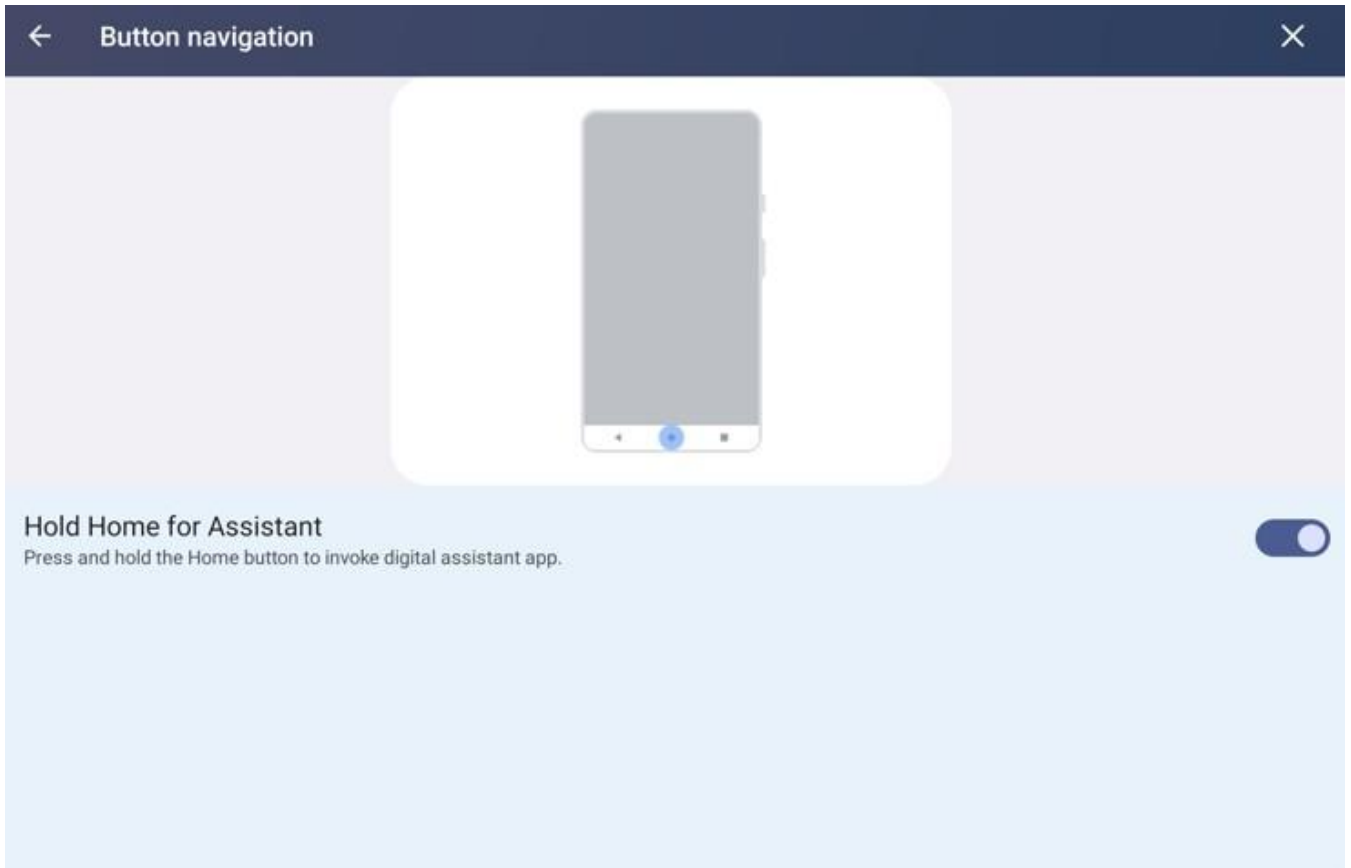

⑥ 3-button navigation

- Use the three buttons at the bottom of the screen to go to the Home screen or switch apps.
- To launch the Digital Assistant app, press and hold the Home button.

5.10 Accessibility

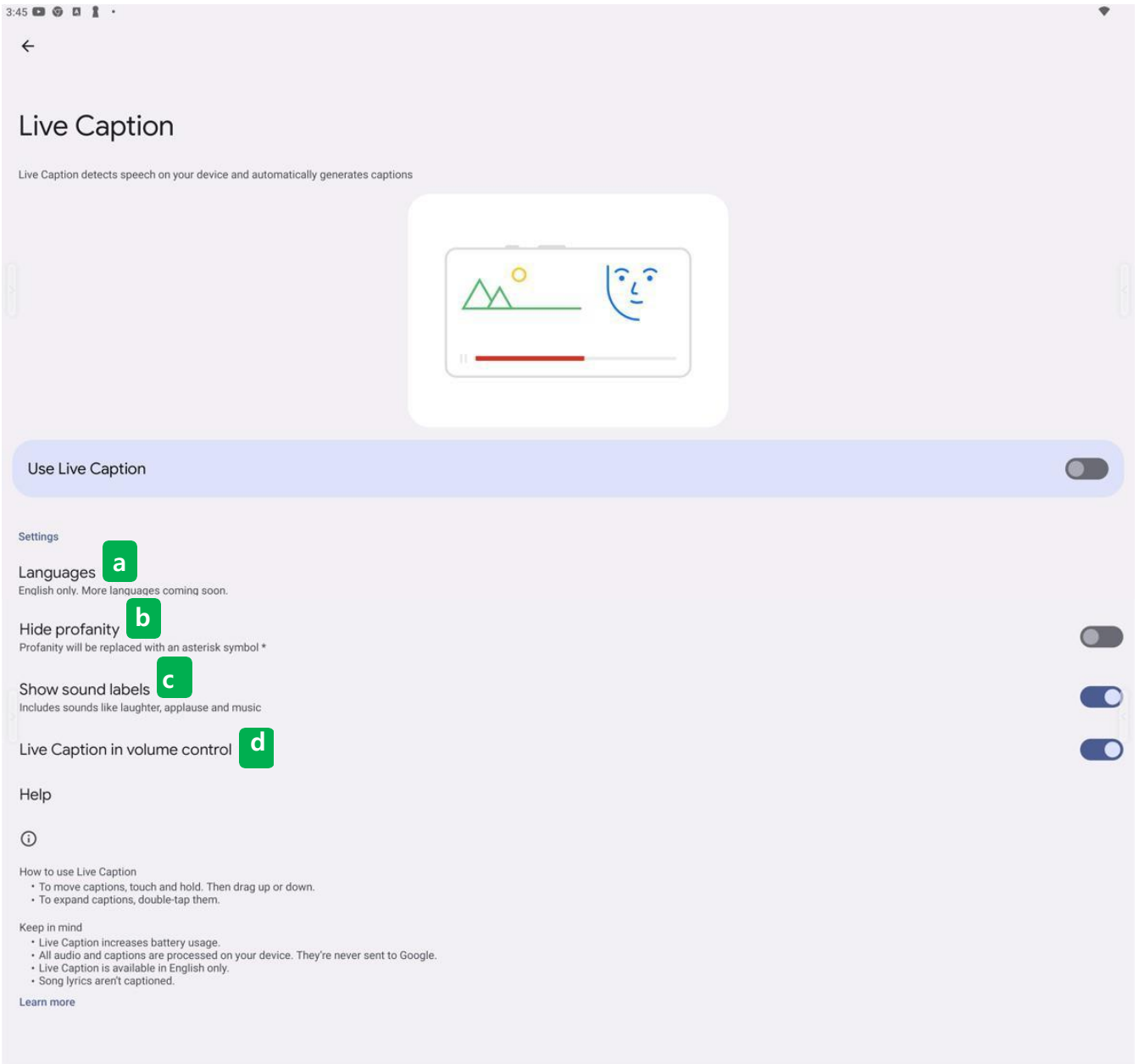

⑨ Live Caption

- The real-time subtitle feature detects voice on the device and automatically generates subtitles.

a. Languages

- Currently, it is only available in English and other languages will be supported soon.

b. Hide profanity

- The swear words of the subtitles are replaced by the asterisk (*).

c. Show sound labels

- It includes sounds such as laughter, clapping and music.

d. Live Caption in volume control

- Set the use of real-time subtitles in volume adjustment.

5.10 Accessibility

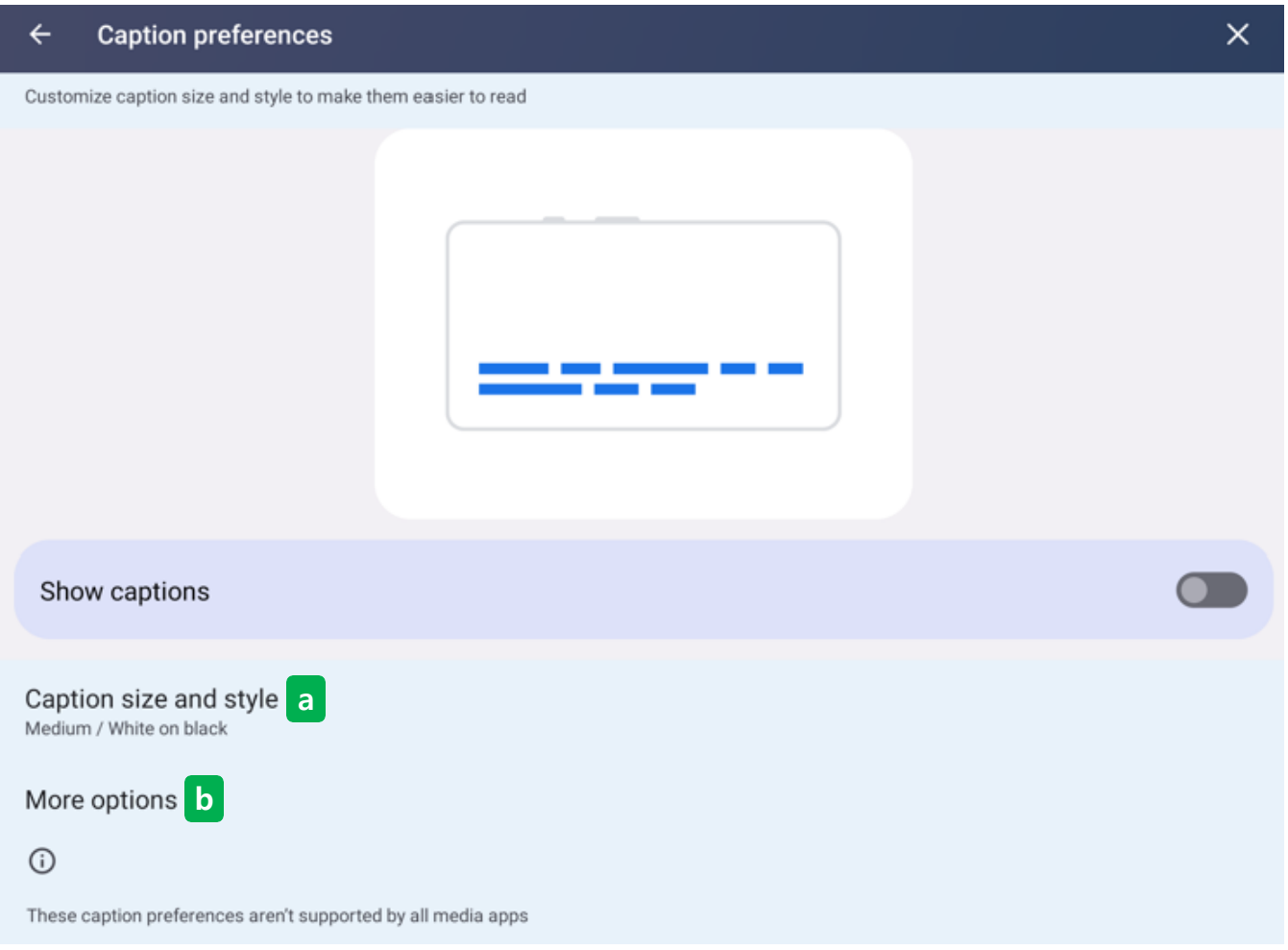

⑩ Caption preferences

- Users can set how subtitles are displayed.

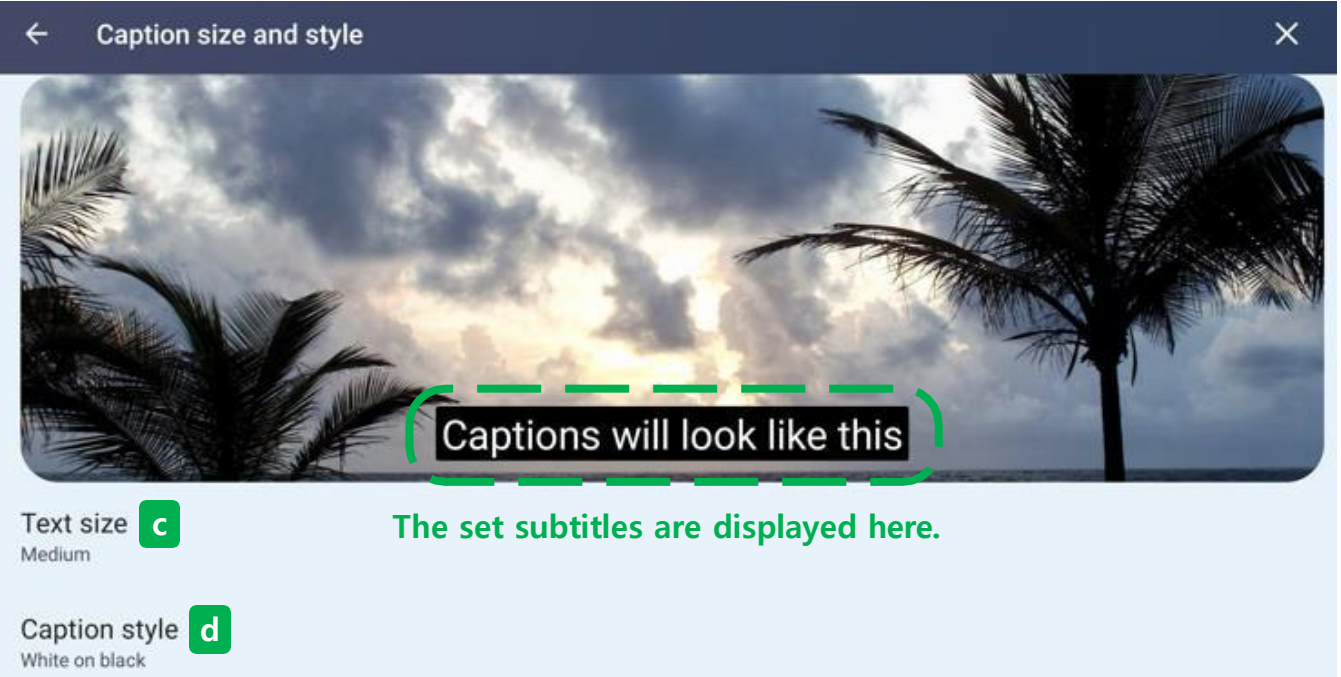

③ Caption size and style

- Users can set the size and font style of the subtitles.

5.10 Accessibility

Text size Medium

Text size

Very small

Small

Medium

Large







Very large

© Text size

- Set the text size of the subtitles.

Caption style White on black

Caption style

 Set by app	 White on black	 Black on white	 Yellow on black	 Yellow on blue
 Custom				

Ⓓ Caption style

- Sets the style of subtitles.

5.10 Accessibility

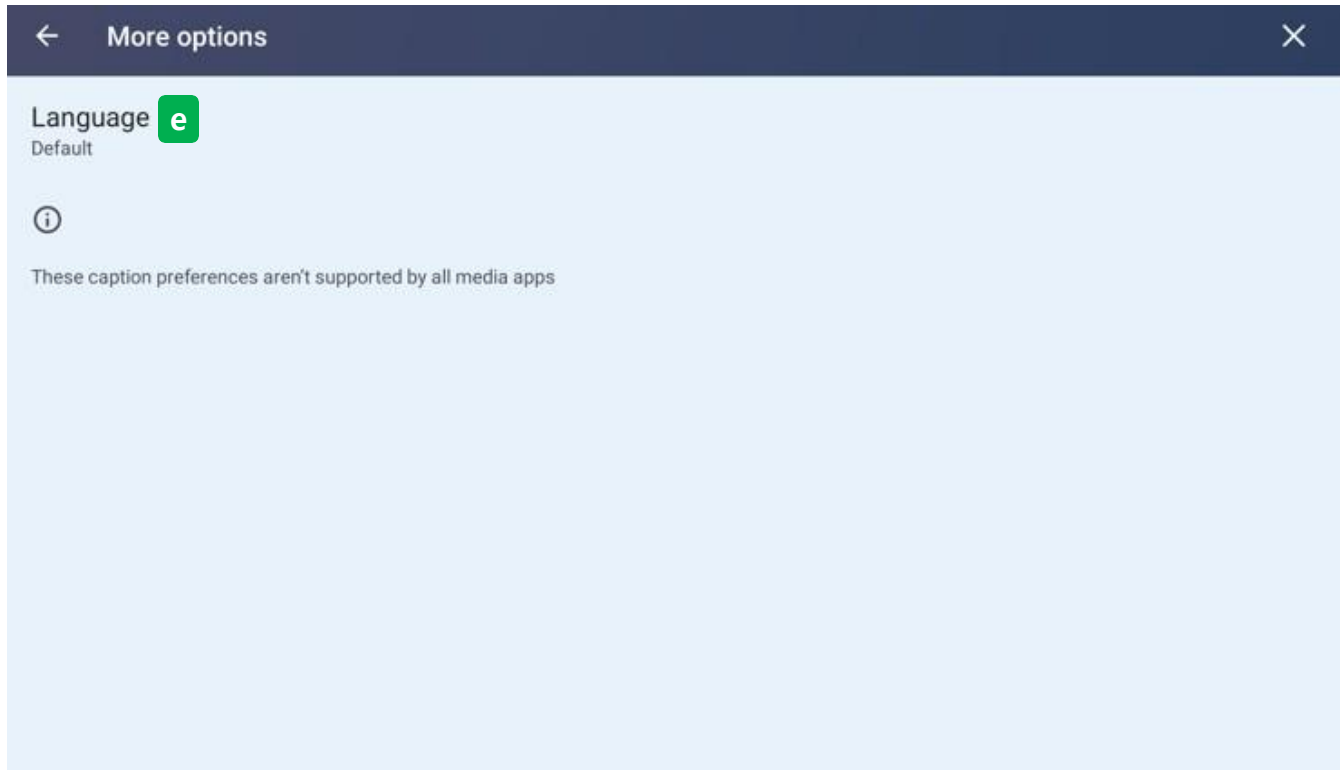

ⓑ More options

- Additional options set the language displayed as subtitles.

Ⓢ Feature supplement descriptions

- These subtitle preferences are not supported by all media apps.

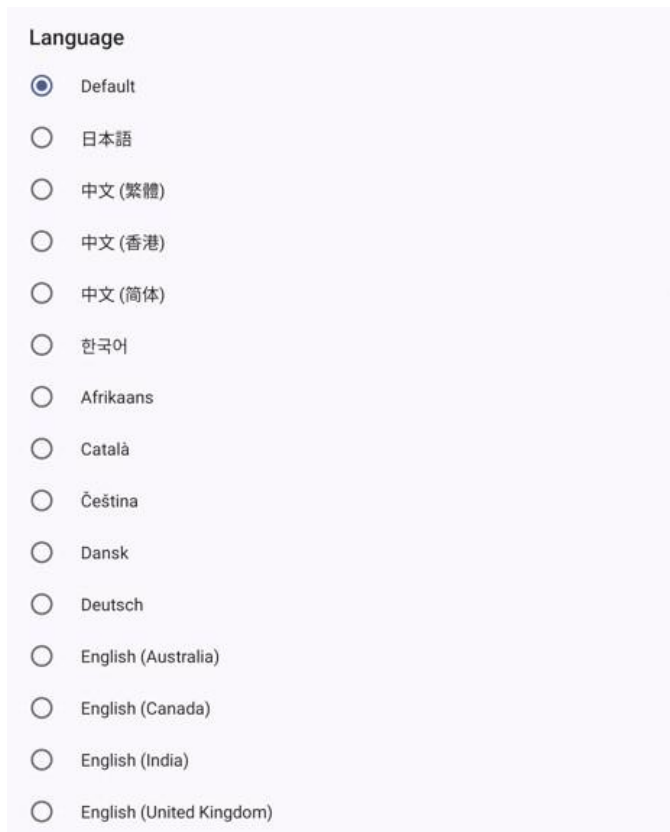

Ⓣ Language

- An additional option is available to set the language in which the subtitles are displayed. Currently, only English is supported.

5.10 Accessibility

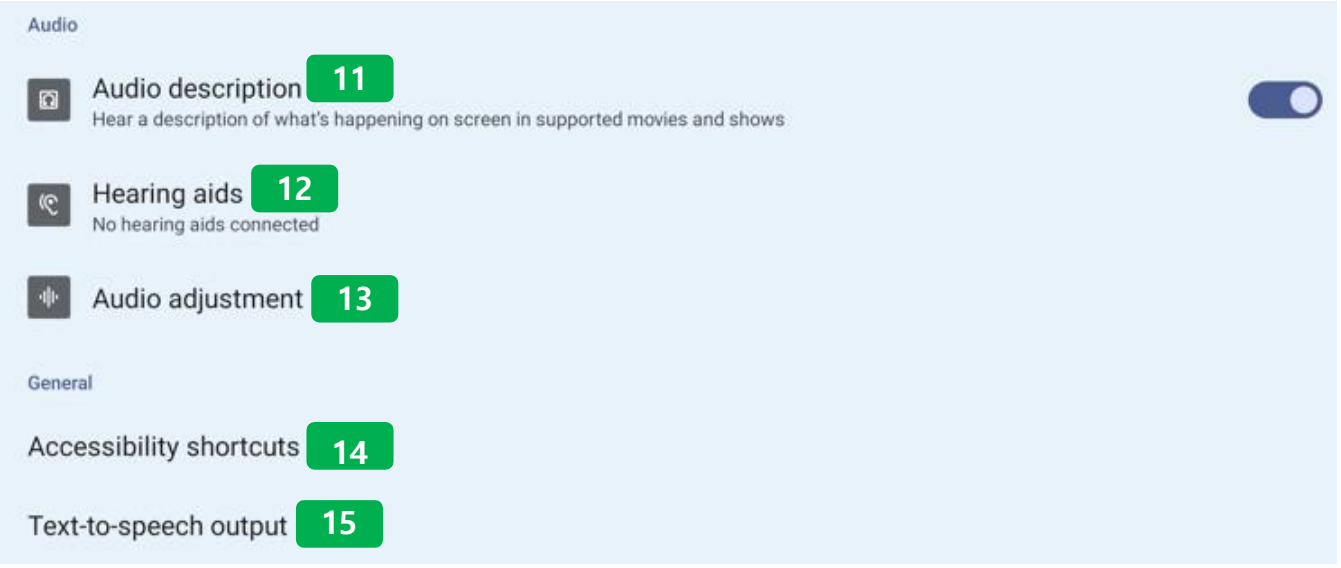

11 Audio description

- Listen to the situation of movies and programs with audio description as a voice description.

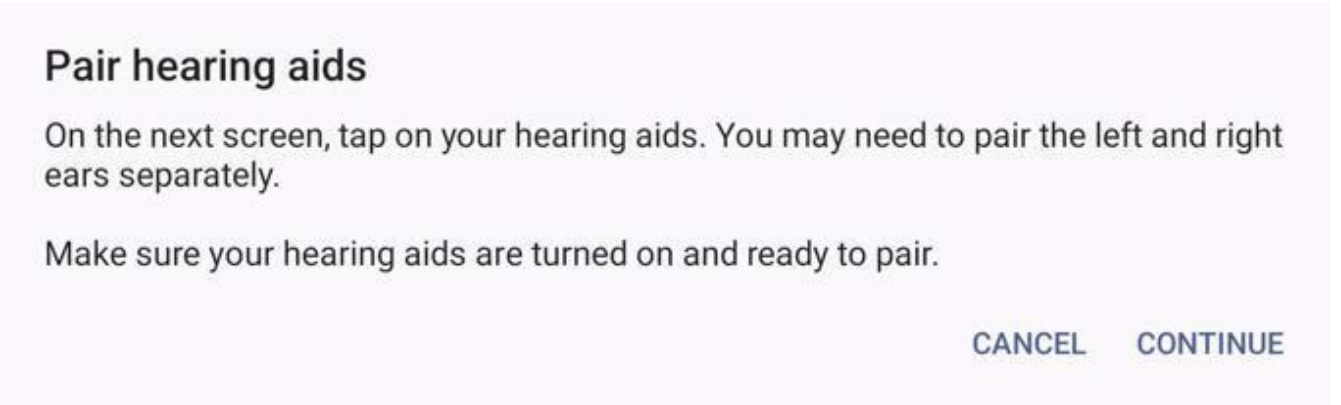

12 Hearing aids

- Pair the hearing aid and connect.

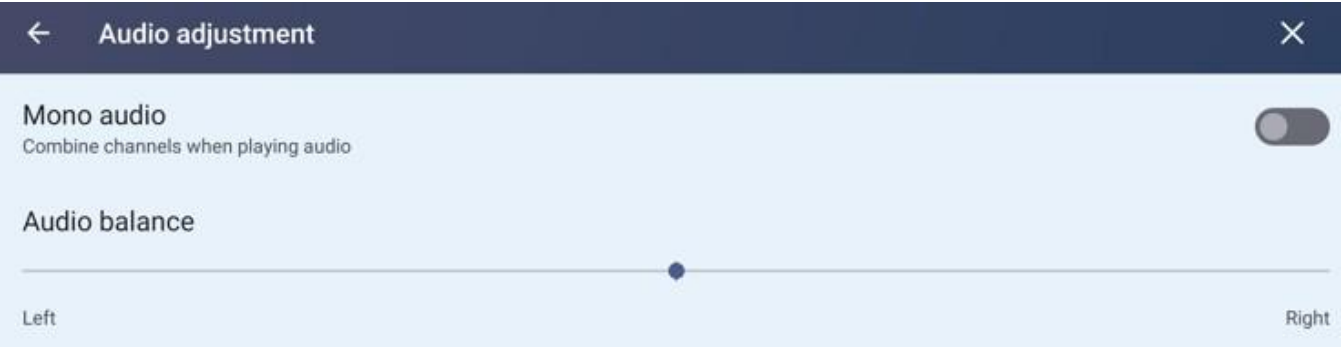

13 Audio adjustment

- When playing audio, unify the channel or adjust the left and right speaker direction.

5.10 Accessibility

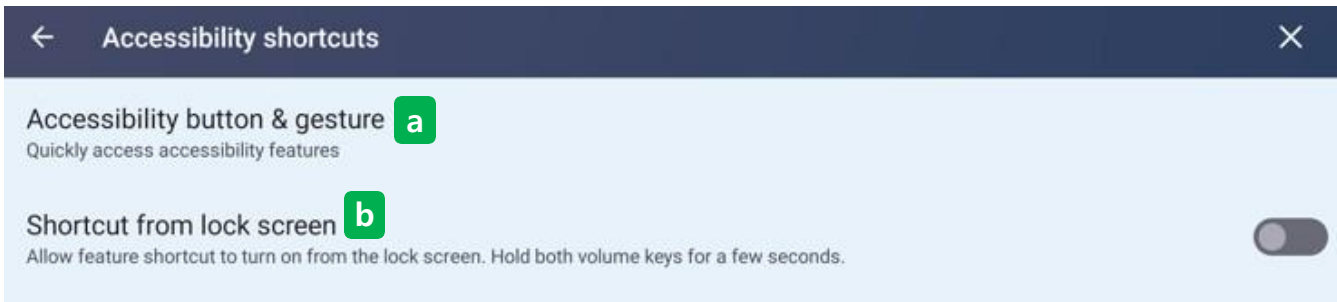

14 Accessibility shortcuts

- Set it to run quickly to accessibility functions.

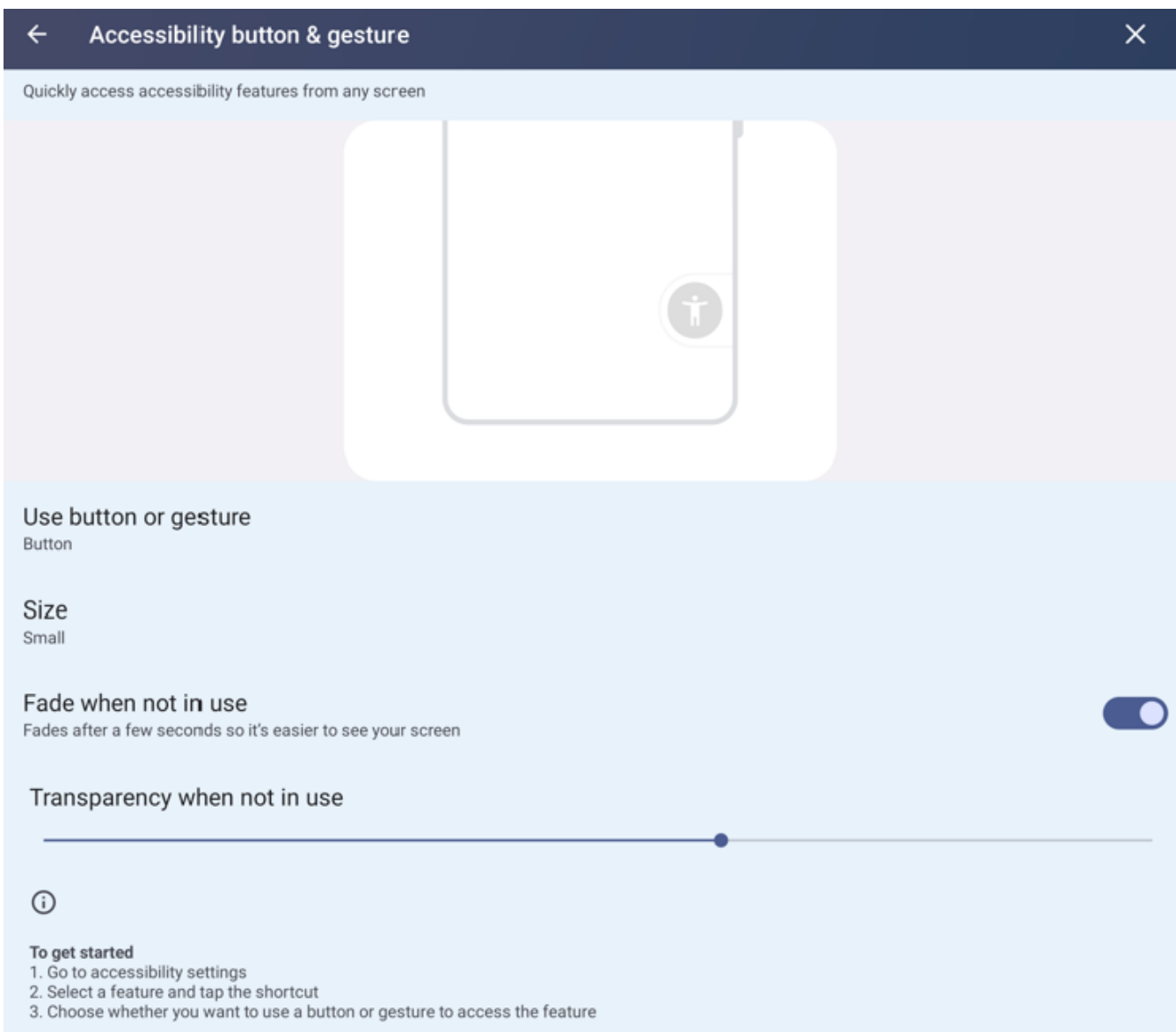

a Accessibility button & gesture

- Users can set the accessibility function quickly on any screen.
- You can enable shortcut keys on the lock screen, or adjust the shortcut icon size and transparency.

b Shortcut from lock screen

- Allows the use of feature shortcuts on the lock screen.

5.10 Accessibility

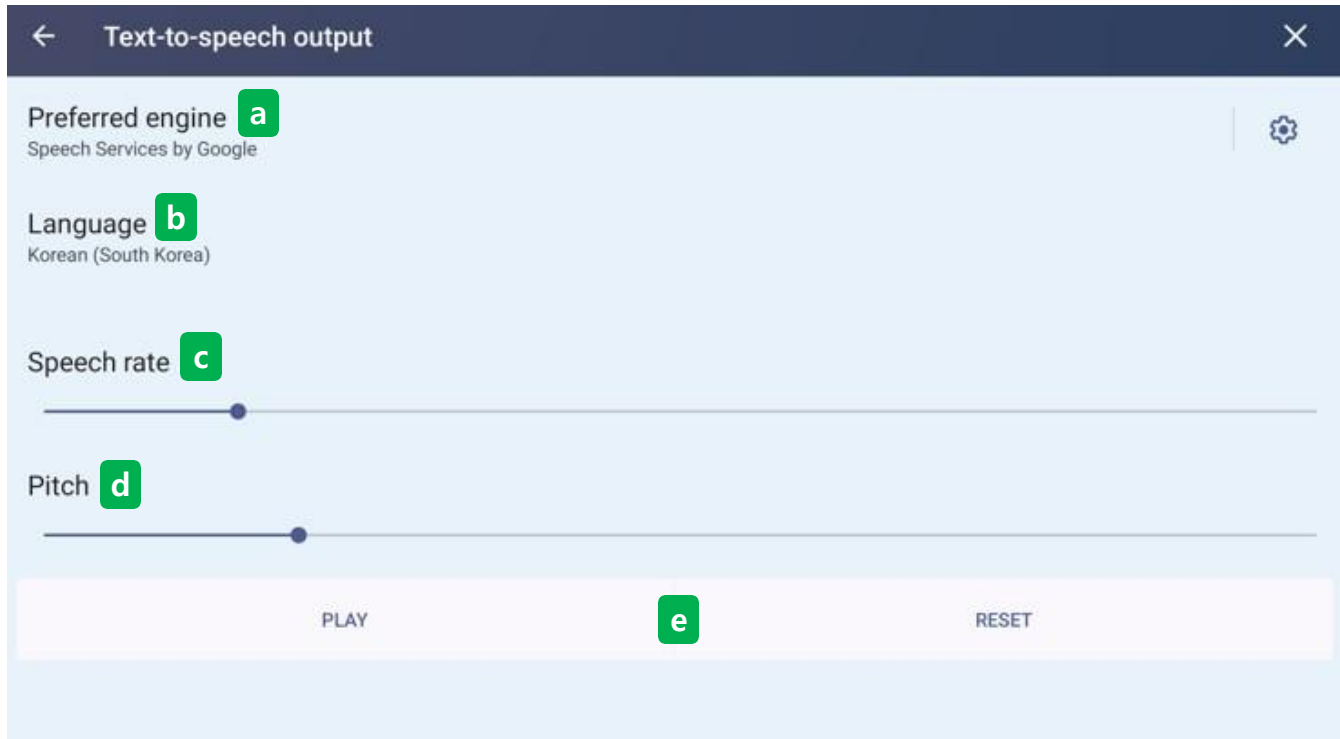

15 Text-to-speech output

- Sets the feature when the system reads text aloud.

a Preferred engine

- Select the default engine that reads the voice. Basically support Google Voice Service.

b Language

- Set a language with voice.

c Speech rate

- Adjust the speed of voice.

d Pitch

- Adjust the tone of the voice.

e Play & reset

- Users can listen to the set voice by pressing the play button.

- To return to the default setting, press the initialization button.

5.11 Security



❖ Security

- Users can check or upgrade the product's Android internal security system.

5.11.1 Security status

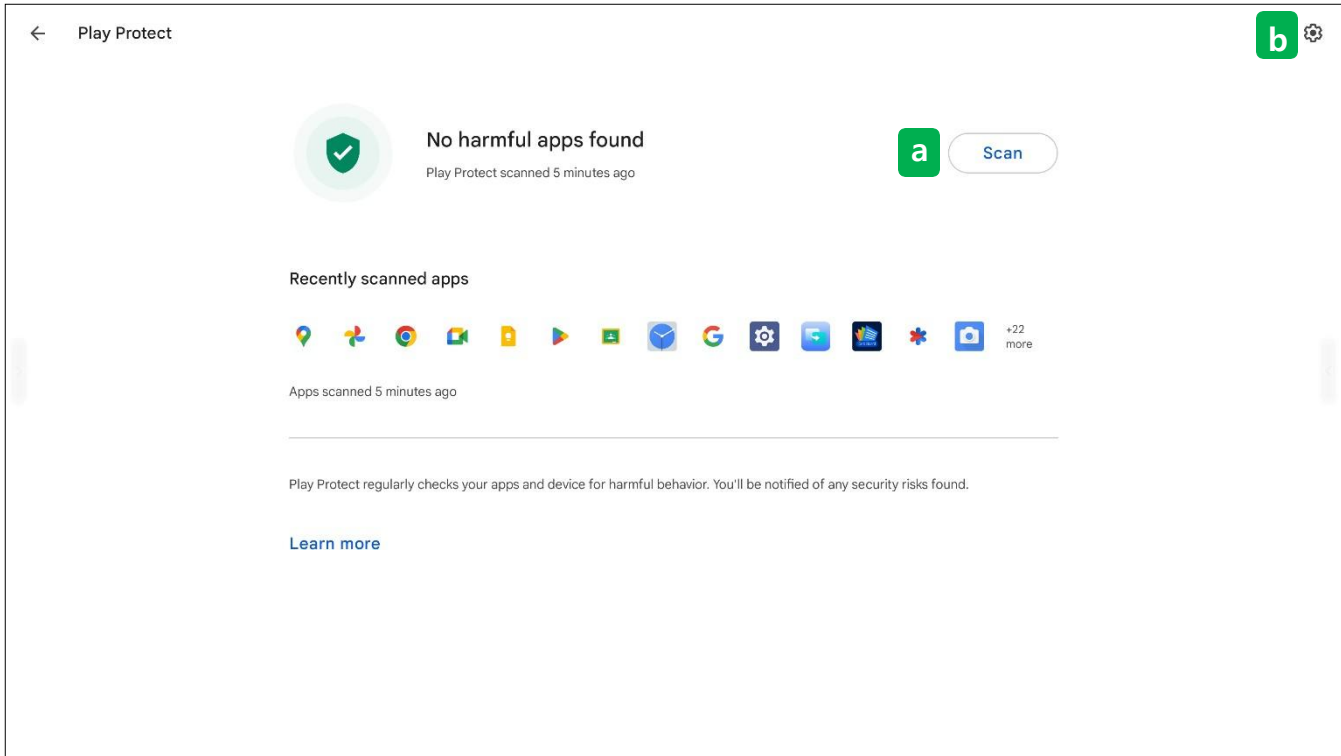

1 Google play protect

- It inspects the harmfulness of the product internal Android App to increase the systemic stability of the product.

a. Scan

- Press the SCAN button to proceed with the hazardous test for the installed app.

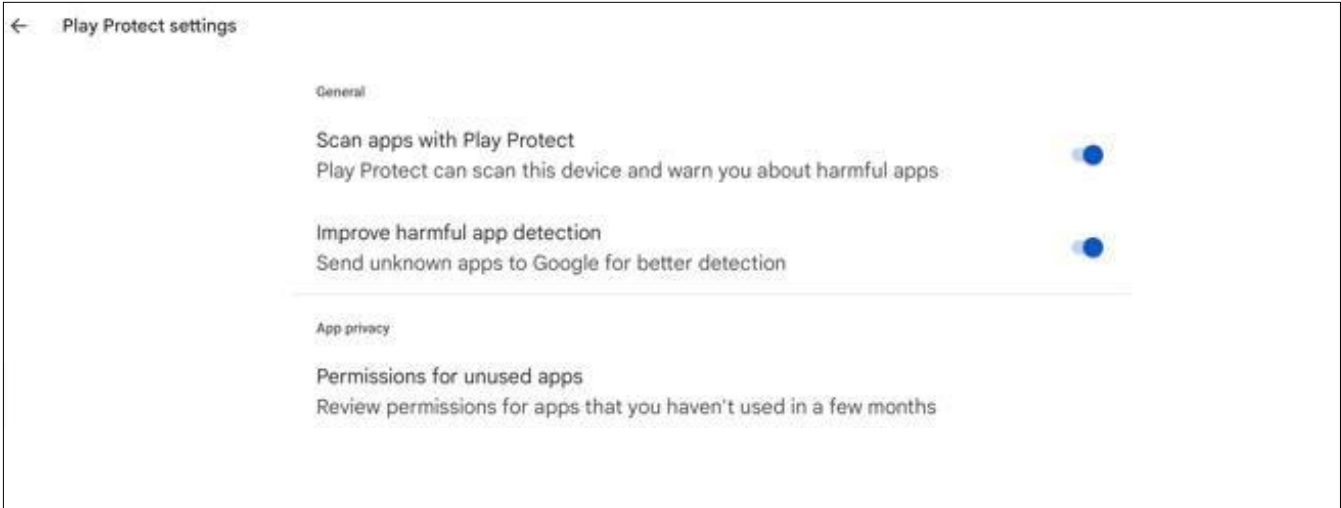

b. Google play protect settings

- Users can change the settings for the hazardous test of the Android App.

5.11.1 Security status

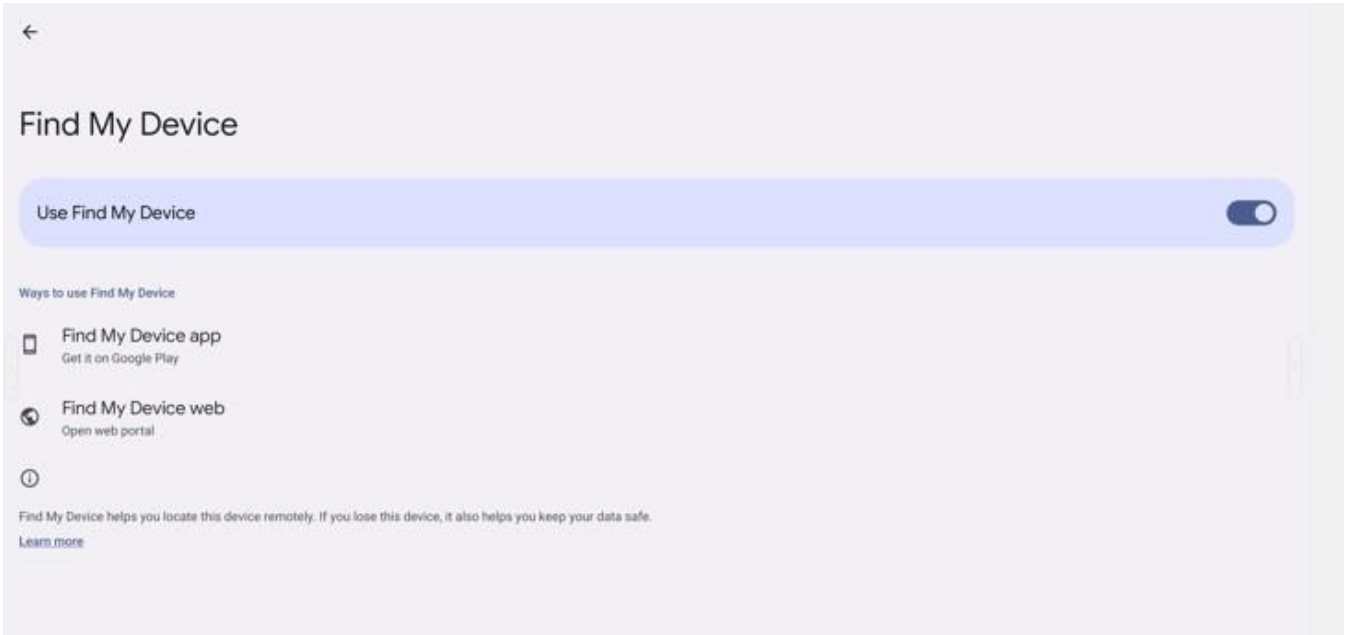

② Find my device

- Find the peripherals logged in with this Google account like this product.

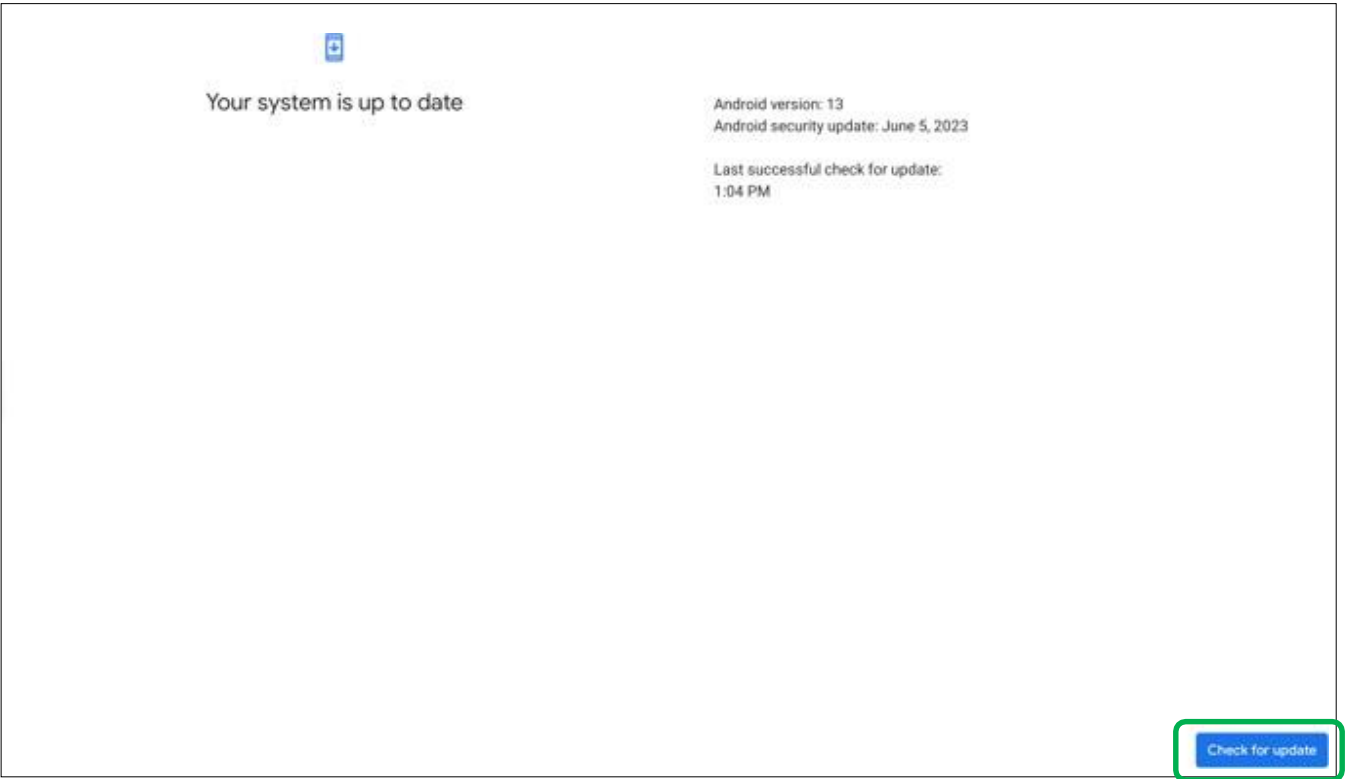

③ Security update

- Users can check the current status of the security update version.
- Users can update the update version by pressing the check for update button.

5.11.1 Security status

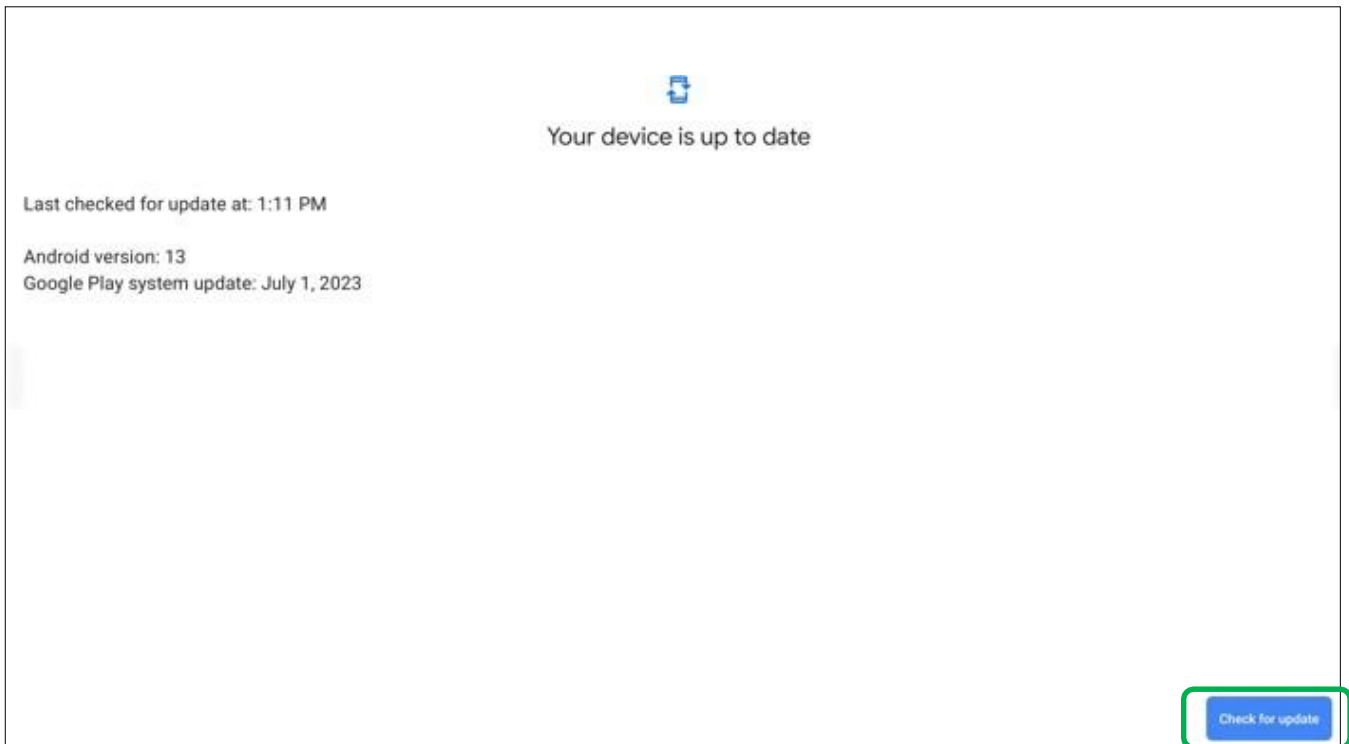

④ Google play system update

- Users can check the current status of the update version of Google Play System.
- Users can update the update version by pressing the check for update button.

5.11.2 Device security

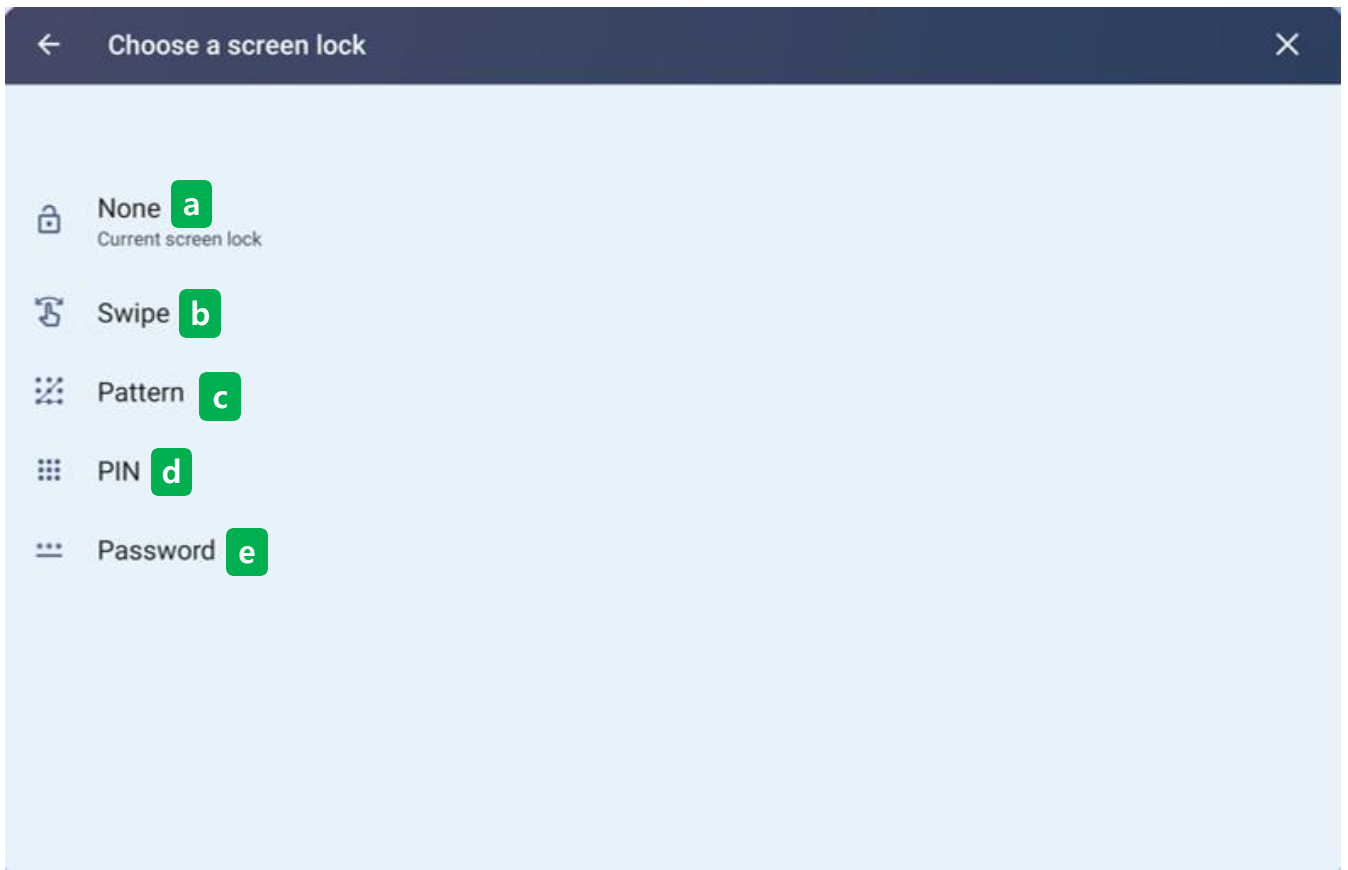

① Screen lock

- Background screen lock is available.

- a. None : Disable the lock feature.
- b. swipe : The locking function can be released by hand sweeping.
- c. Pattern : Users can unlock the lock function by drawing a specified pattern.
- d. PIN : Users can unlock the lock function by entering the specified PIN number.
- e. You can unlock the lock function by entering the specified password.

5.11.2 Device security

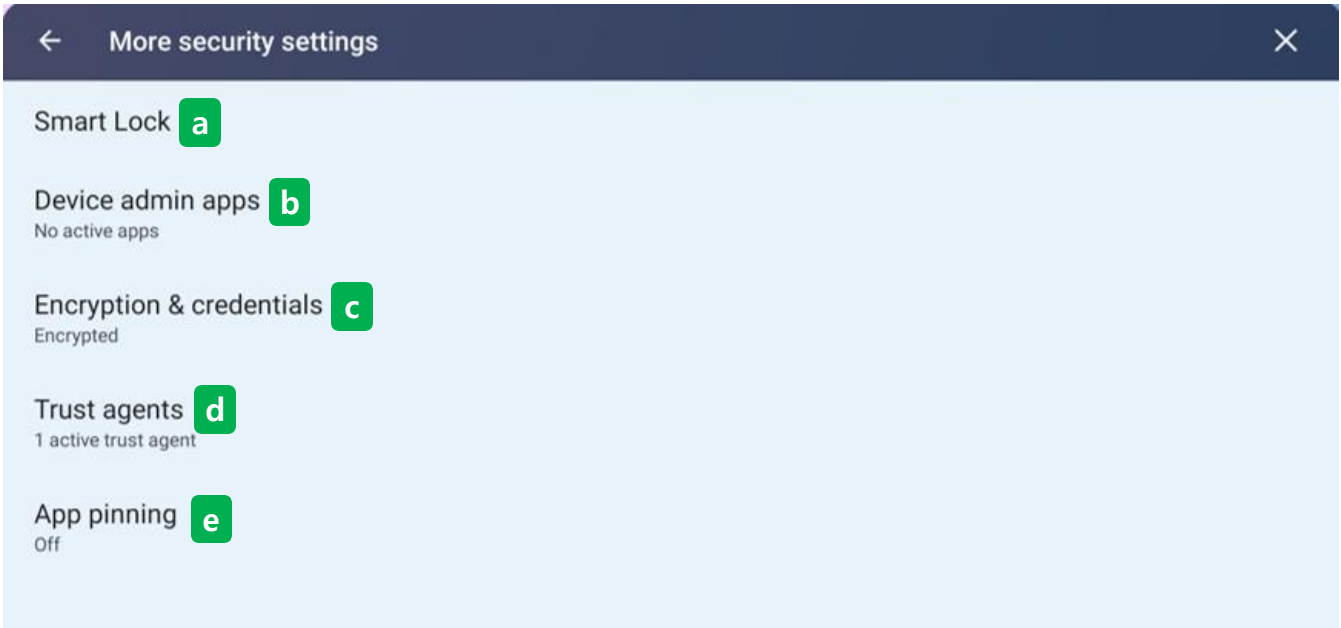

② More security settings

- Additional security settings can be checked.

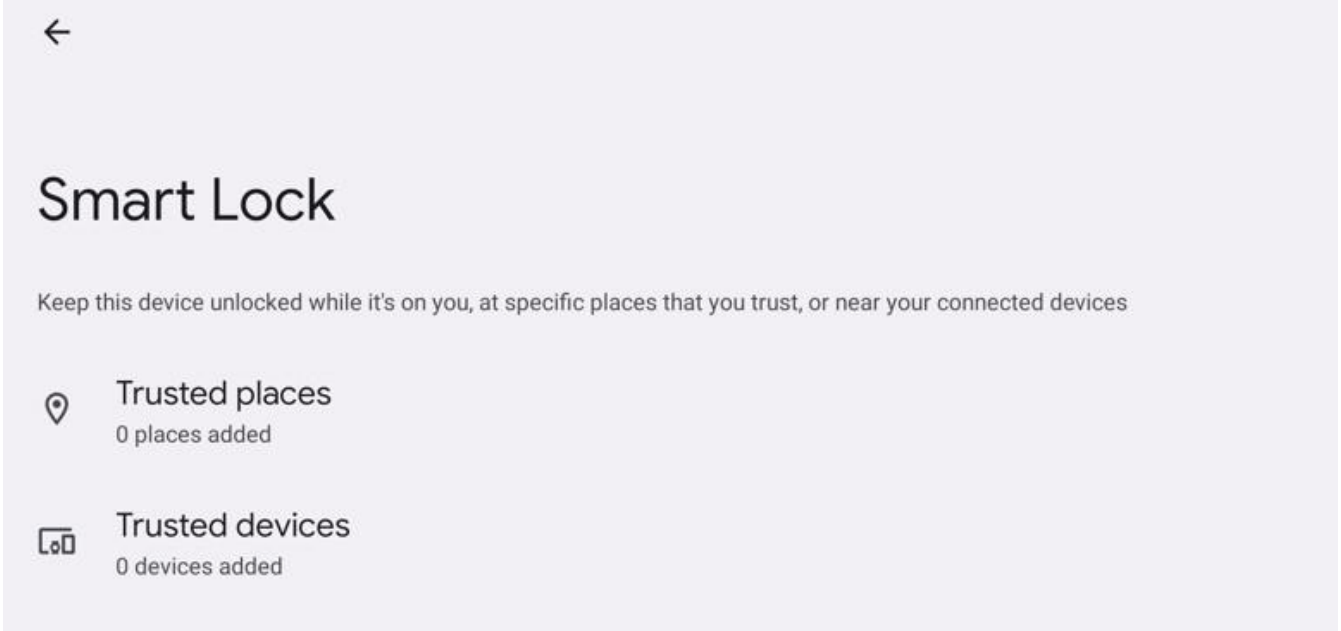

a. Smart Lock

- Trusted places : Locking is automatically released when placed in place by specifying a place.
- Trusted devices : The device is specified and the lock is automatically released when the device is around.

5.11.2 Device security

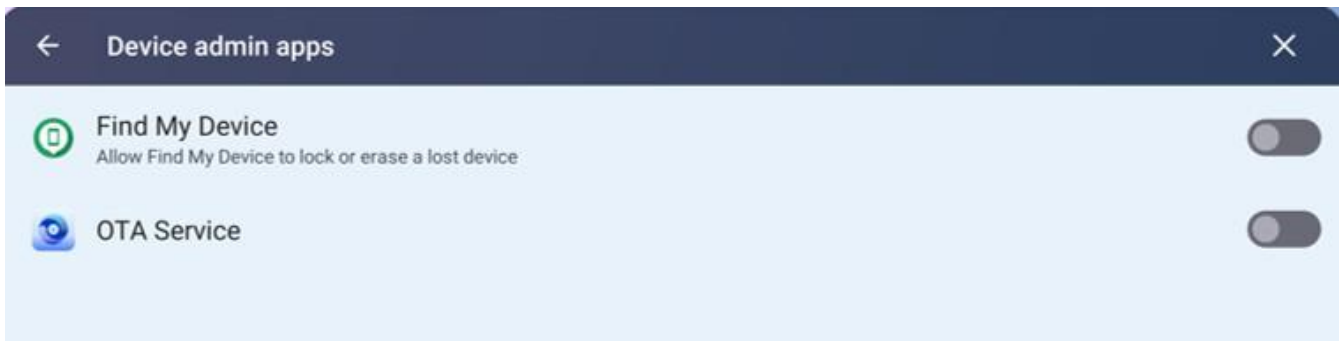

b. Device admin apps

- Find my device app can be enable/disable.
- OTA Service app can be enable/disable.

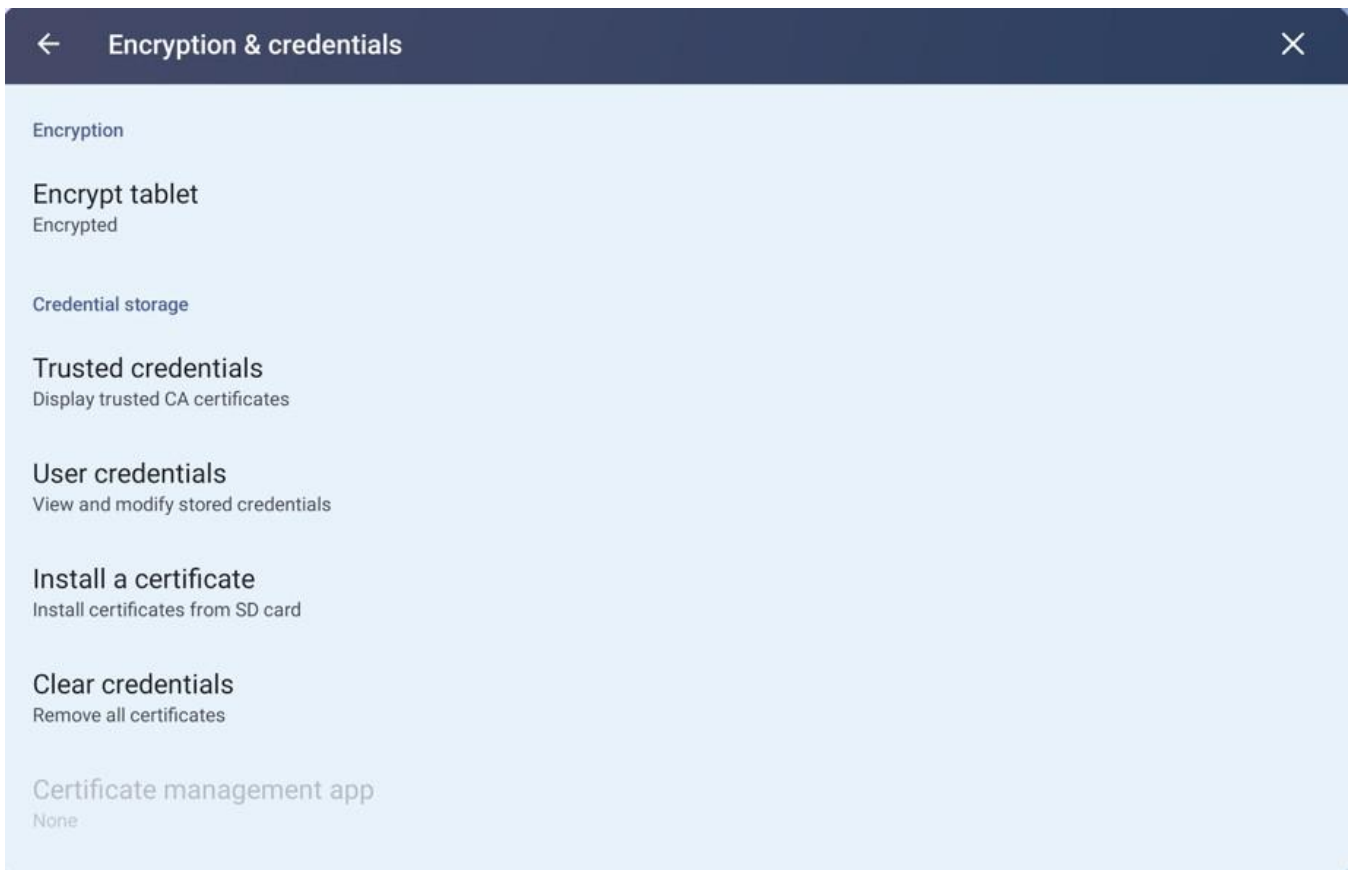

c. Encryption & credentials

- Encrypt tablet : Users can check the tablet encryption.
- Trusted credentials : Displays a list of trusted users' credentials.
- User credentials : View and modify stored user credentials.
- Install a certificate : Install a certificate on device.
- Clear credentials : Delete the certificate installed on the device.

5.11.2 Device security



d. Trust agents

- Smart lock function can be enable/disable.

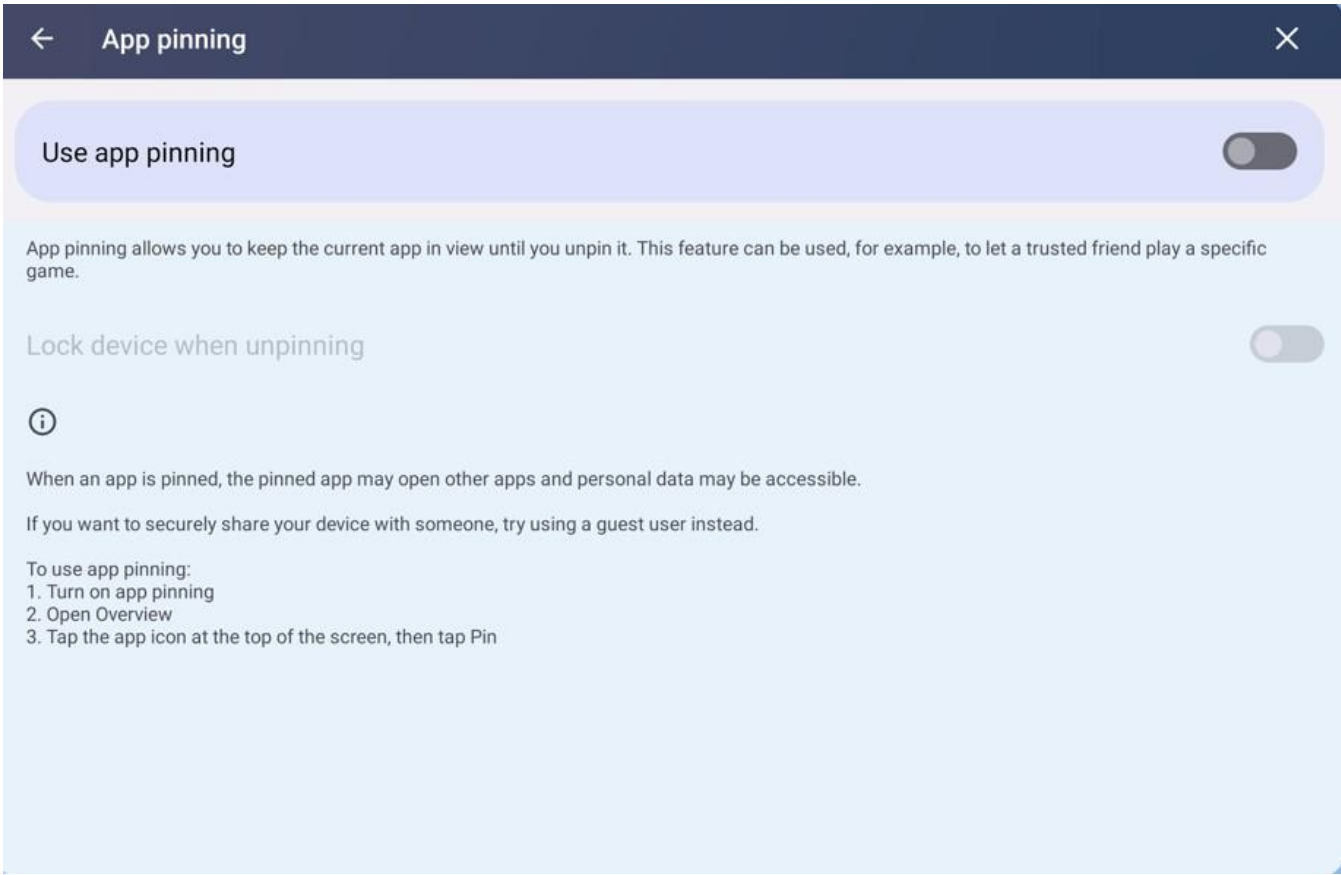

e. App pinning

- Even if the screen of the device is switched by fixing the currently used app, the app will run as it is.

5.12 Privacy

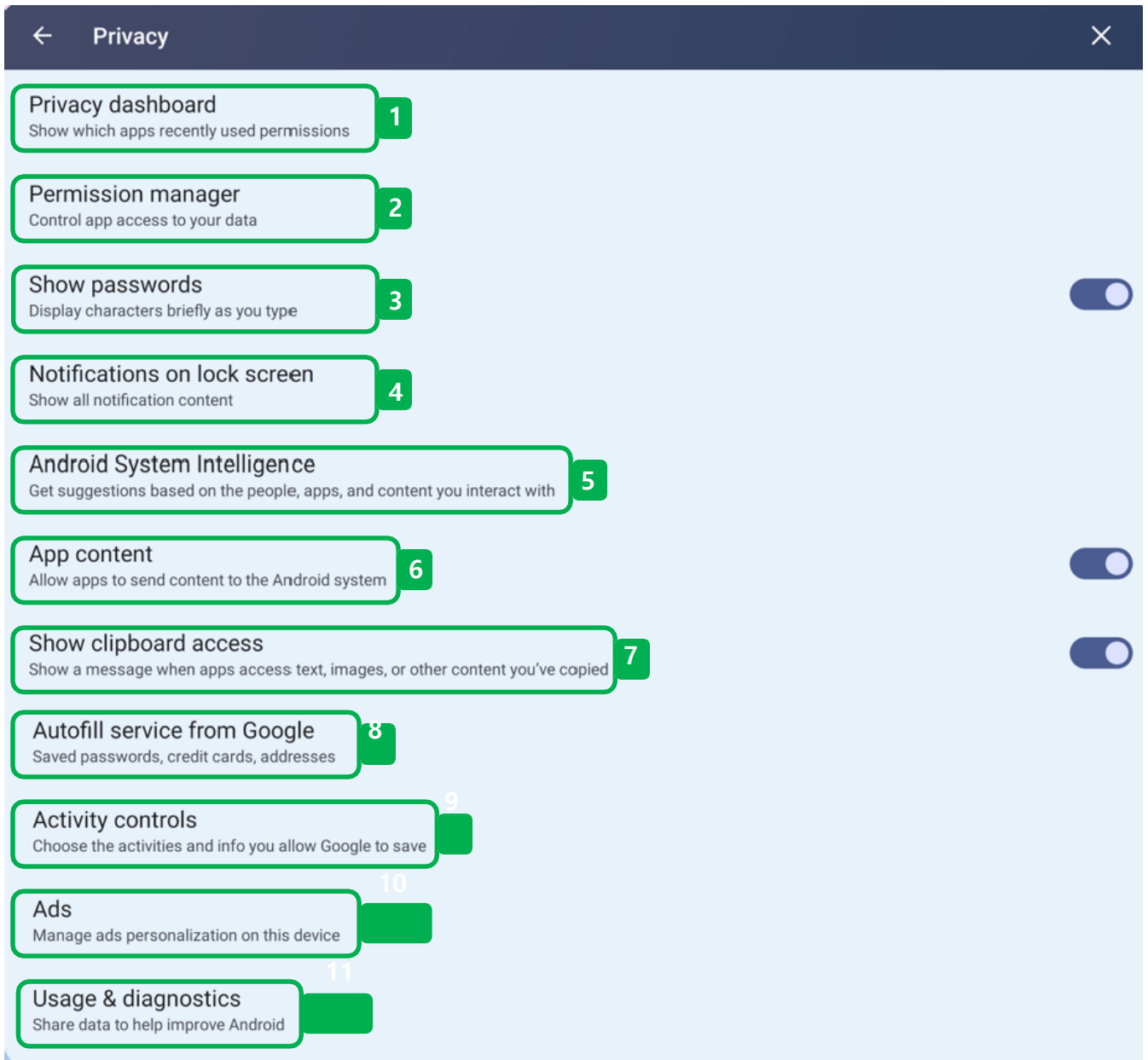

❖ Privacy

- You can manage privacy, permissions, locks, and more.

5.12 Privacy

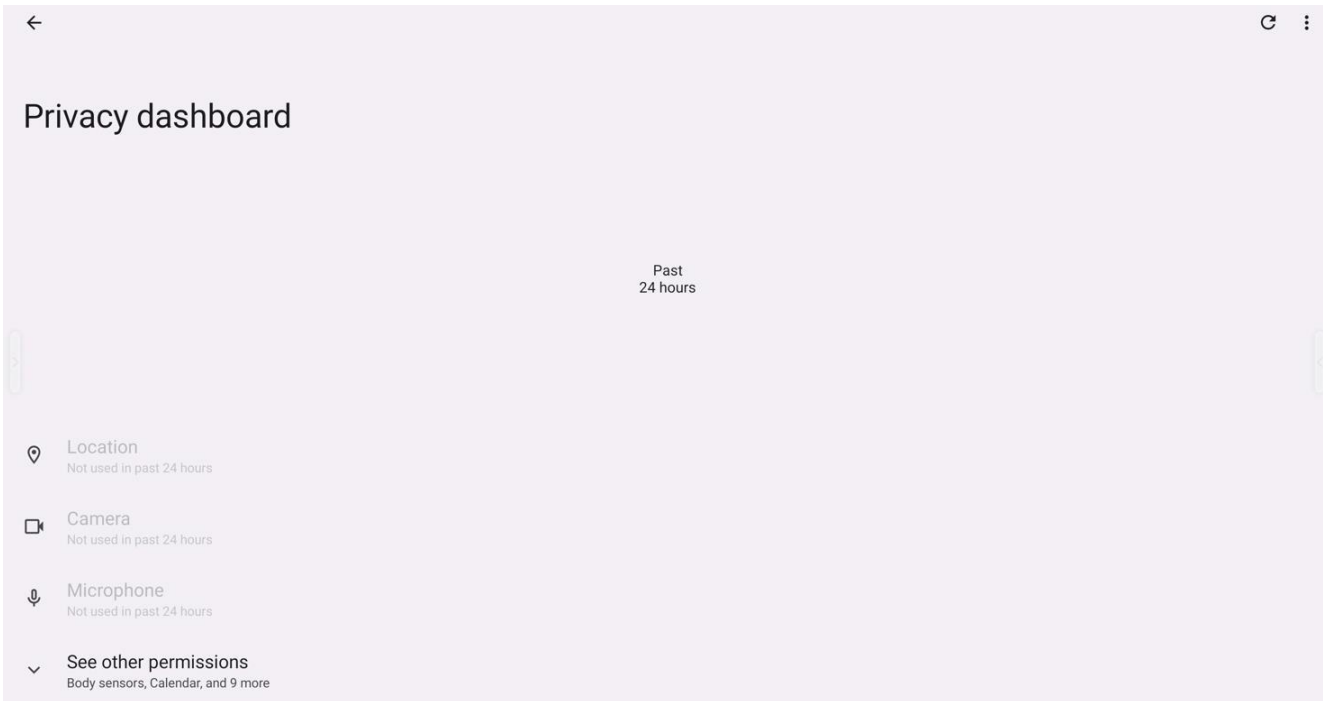

Privacy dashboard

- Shows apps that have recently used permissions.

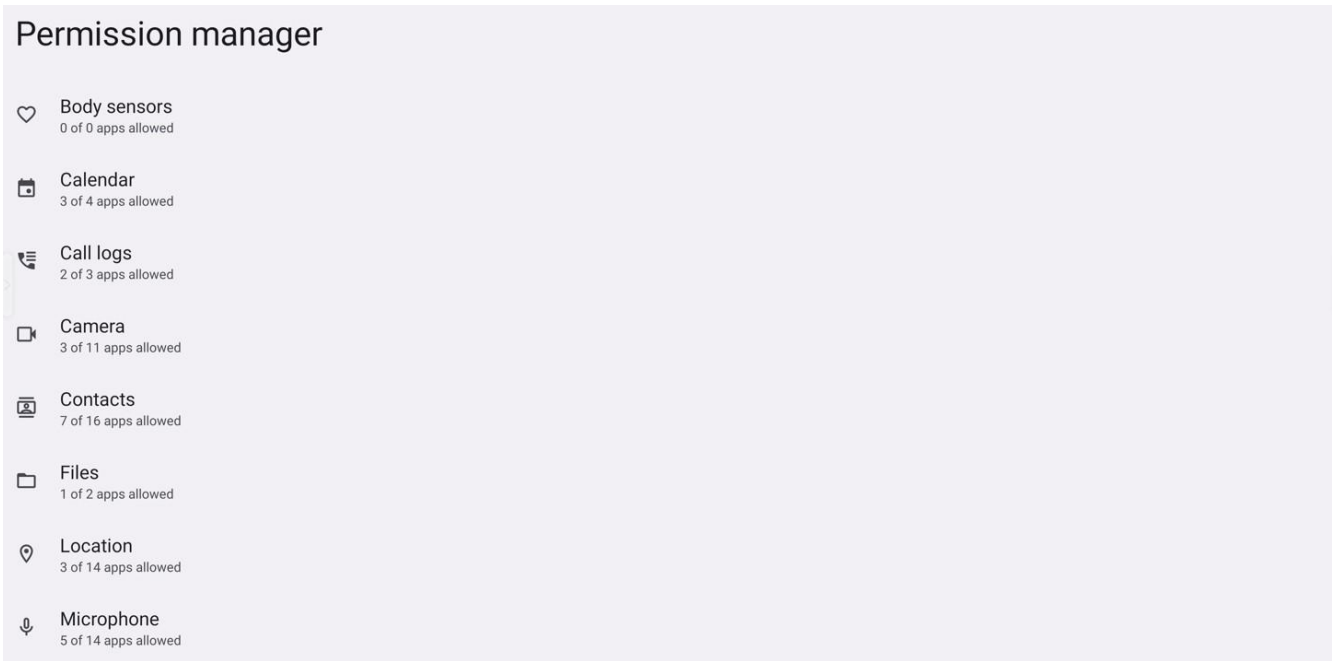

Permission manager

- Manage permissions for apps and other contents on your device.

5.12 Privacy

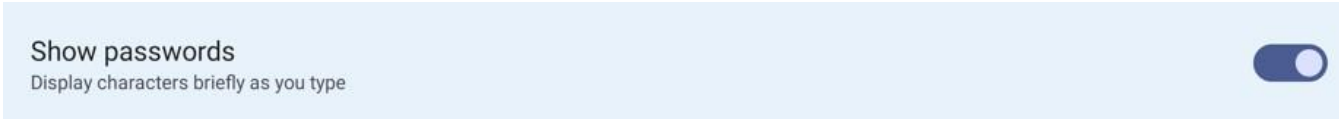

③ Show passwords

- Display characters briefly as you type.

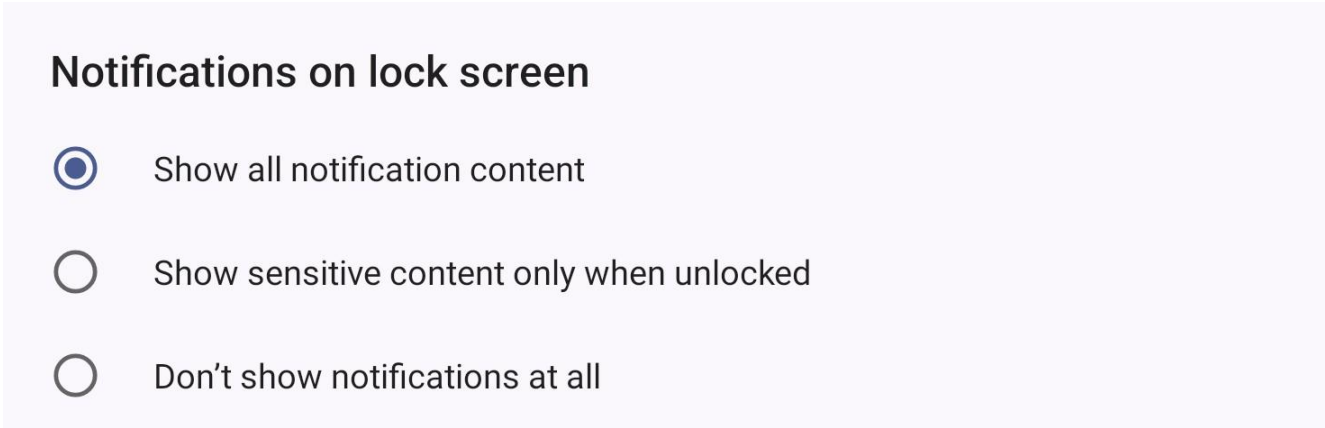

④ Notifications on lock screen

- Choose how you want notifications displayed on the Lock Screen

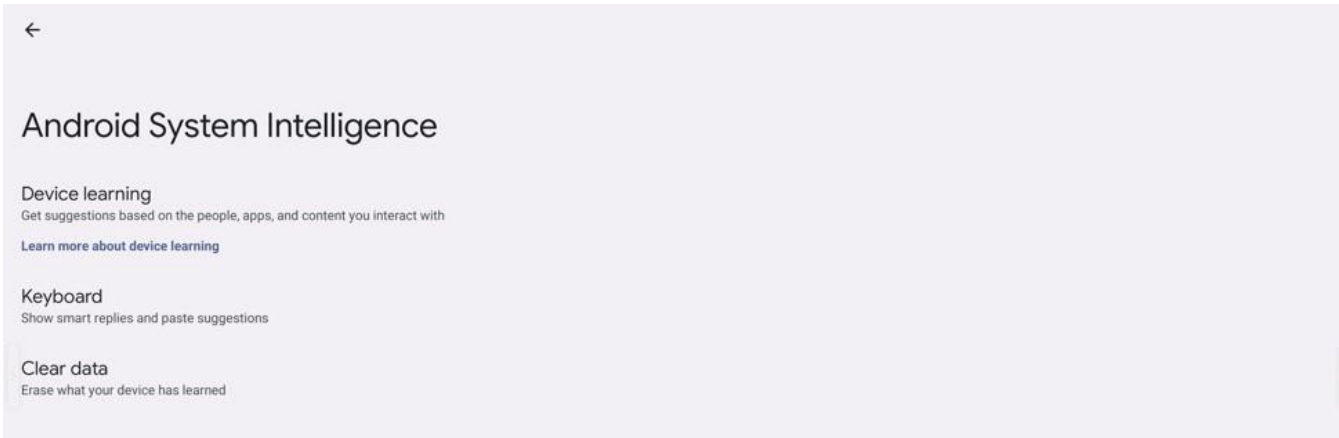

⑤ Android System Intelligence

- Support a variety of smart features that improvement of user experience by learning from your device.

5.12 Privacy

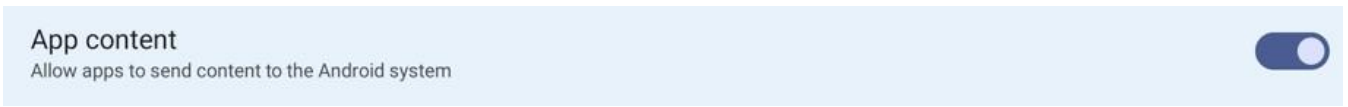

⑥ App content

- Send the content of your apps to the Android system.

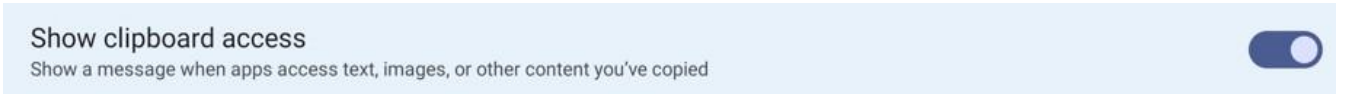

⑦ Show clipboard access

- Show a message when apps access text, images, or other content you've copied



⑧ Autofill with Google

- Instantly recall long sentences of saved passwords, addresses, and more.

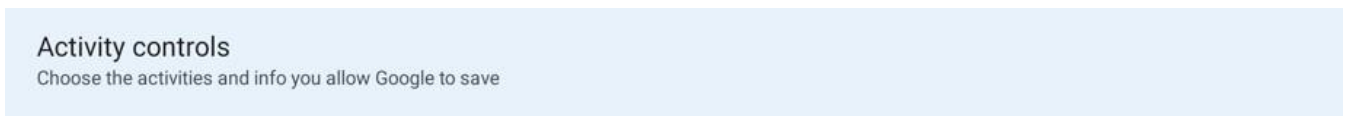

⑨ Activity controls

- Choose the activities and info you allow Google to save (web, location, Youtube, ads, etc)

5.12 Privacy



10 Ads

- Manage Ads settings by Google.

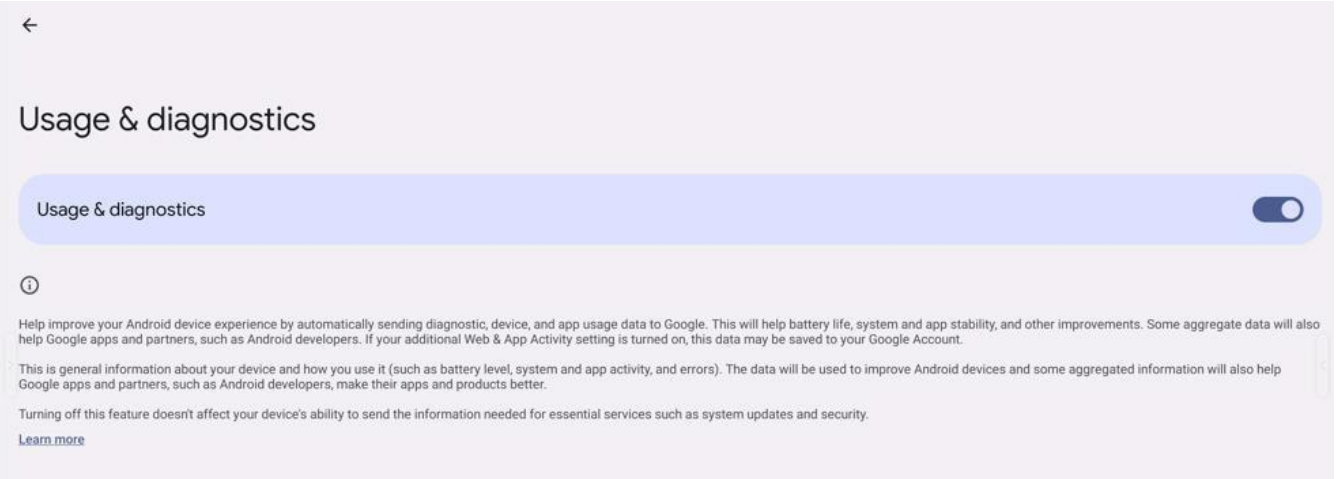

11 Usage & diagnostics

- Connecting data in your device with Google to improve user's device experience.

5.13 Location

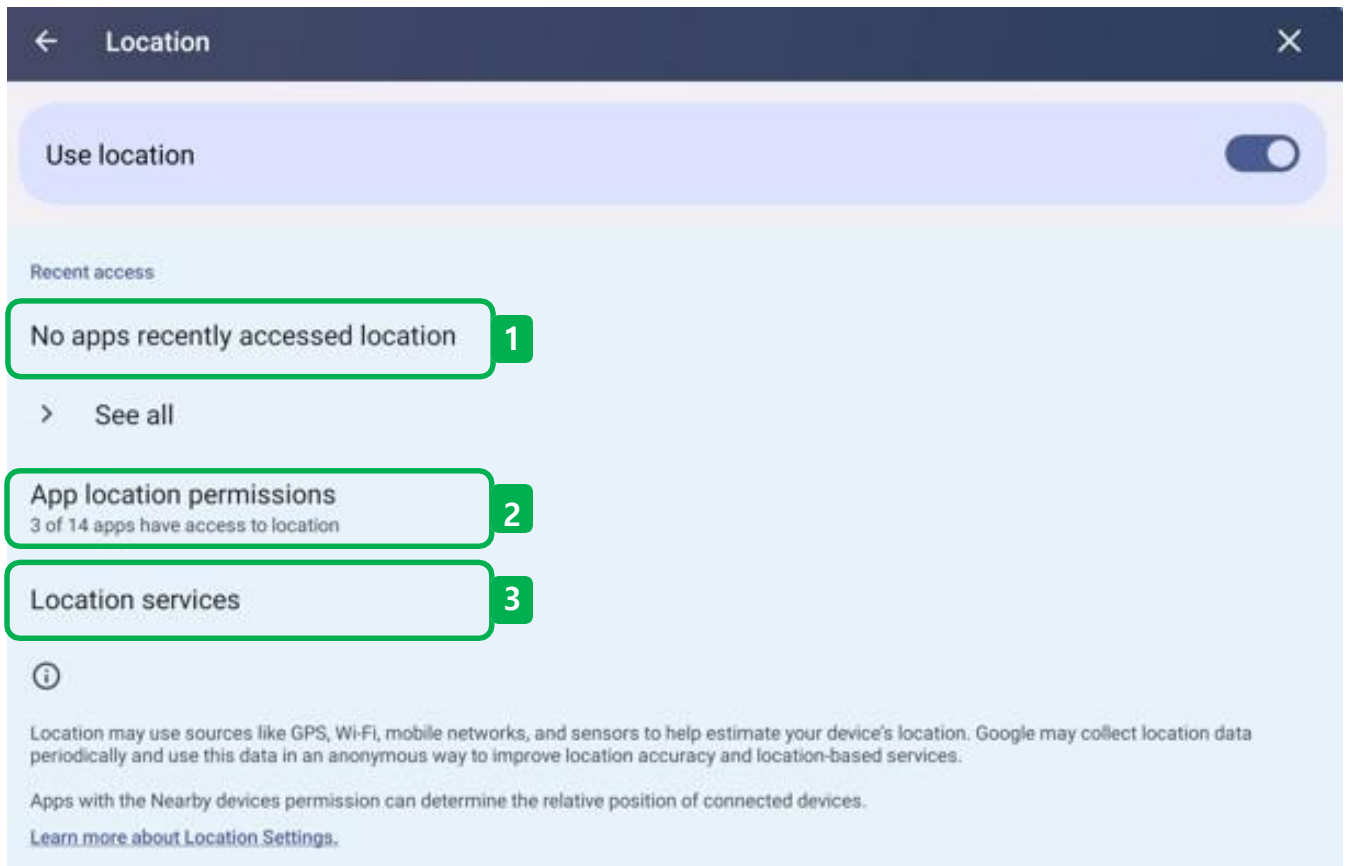

① Recent access

- Get the apps information that have recently requested your location

② App location permissions

- Get the apps information that have recently requested your location

5.13 Location



③ Location services

- Get the view a list of location services that your product is using.

5.14 Safety & emergency

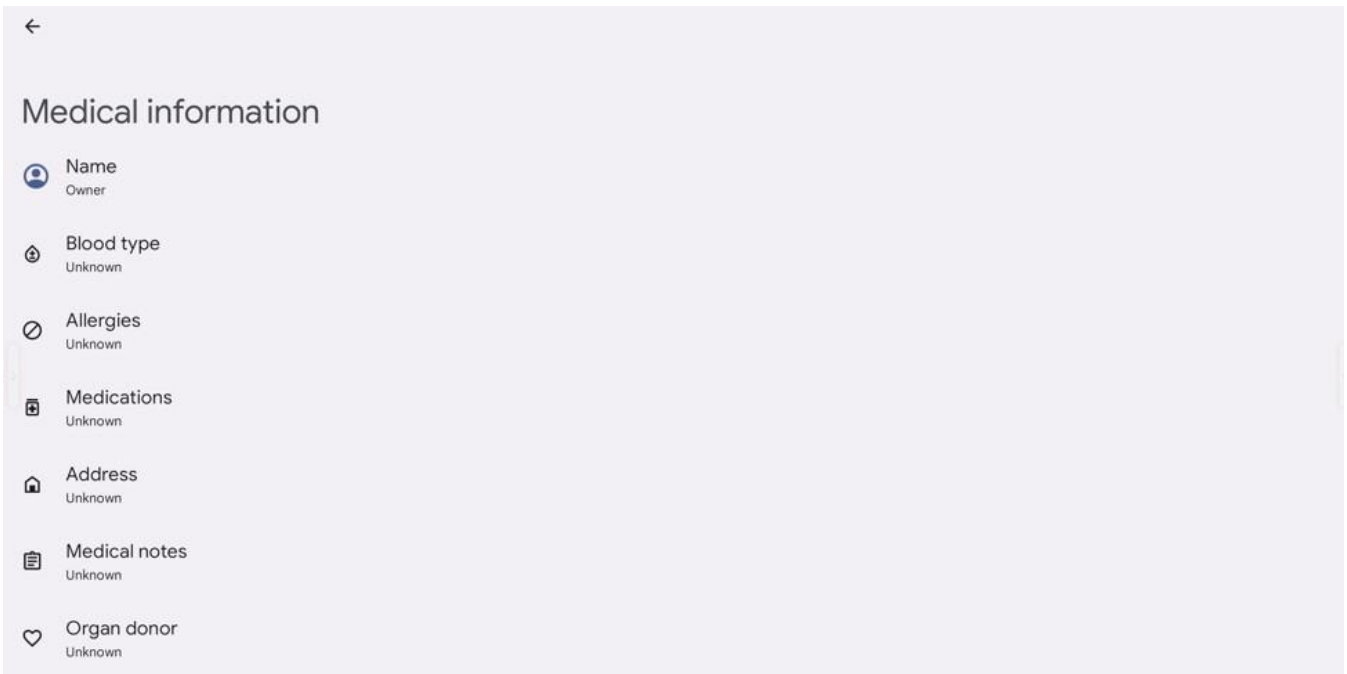
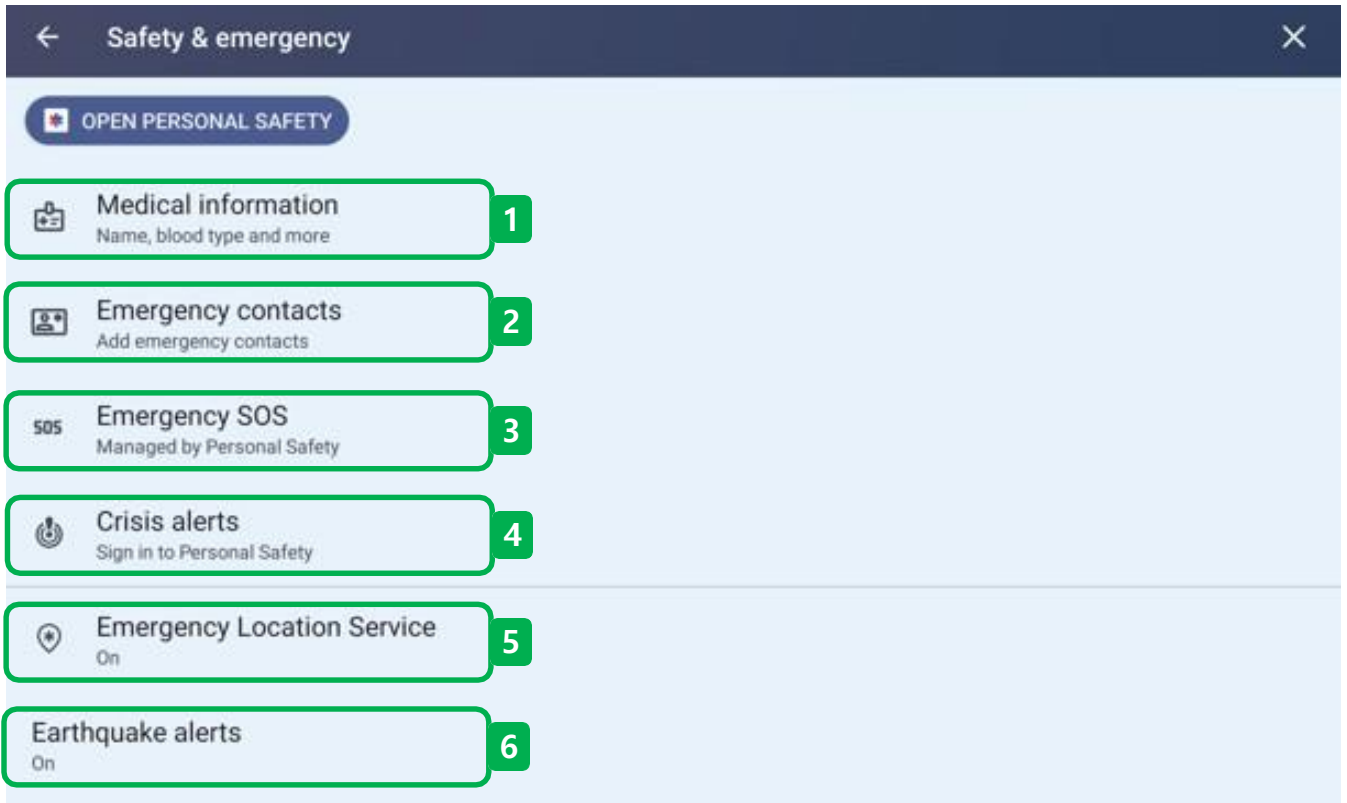

① Medical information

- Enter your medical information.

5.14 Safety & emergency

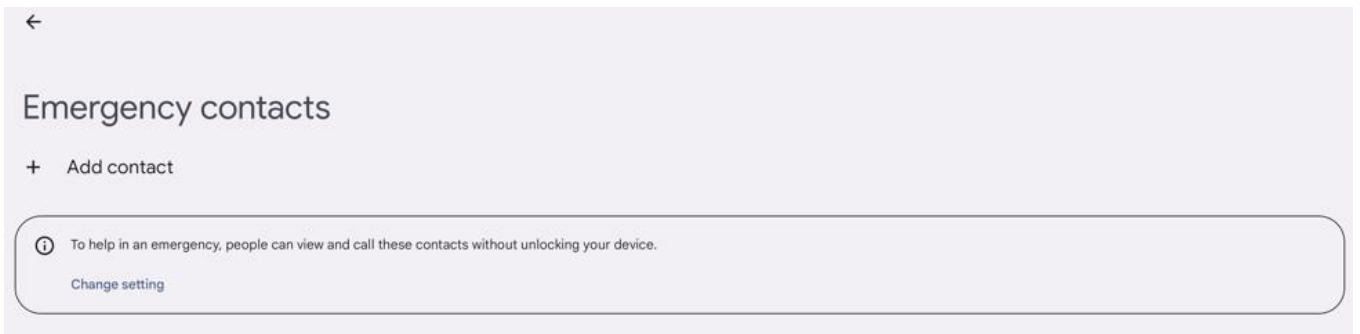

② Emergency contacts

- Add an emergency contact.



③ Emergency contacts

- Press the power key quickly five(5) times to call an set number when you are in an emergency situation

5.14 Safety & emergency

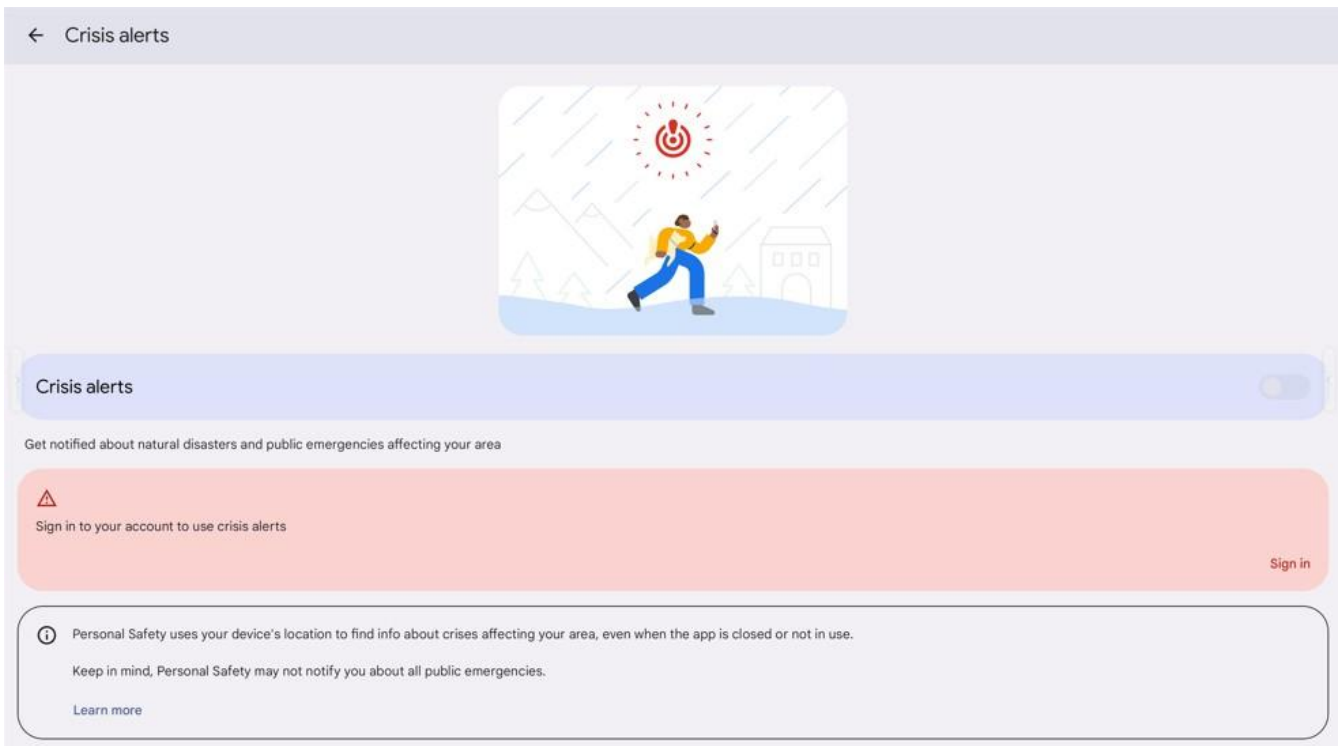

④ Crisis alerts

- Enable/disable the disaster notification feature.

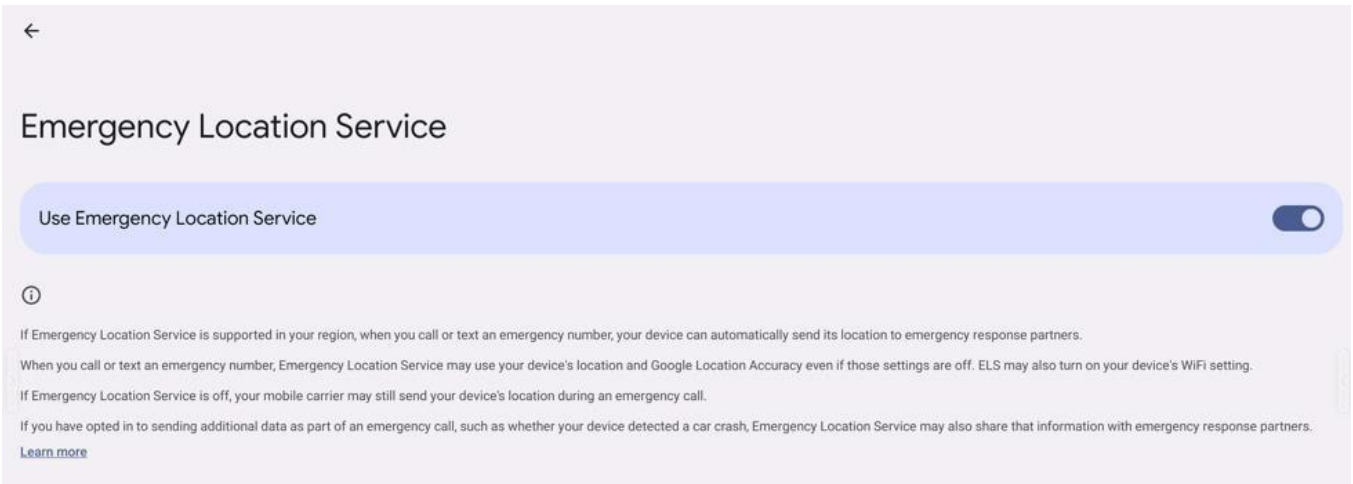

⑤ Emergency Location Service

- Enable/disable the Emergency location alert feature.

5.14 Safety & emergency



⑥ Earthquake alerts

- Enable/disable earthquake alerts.

5.15 Passwords & accounts

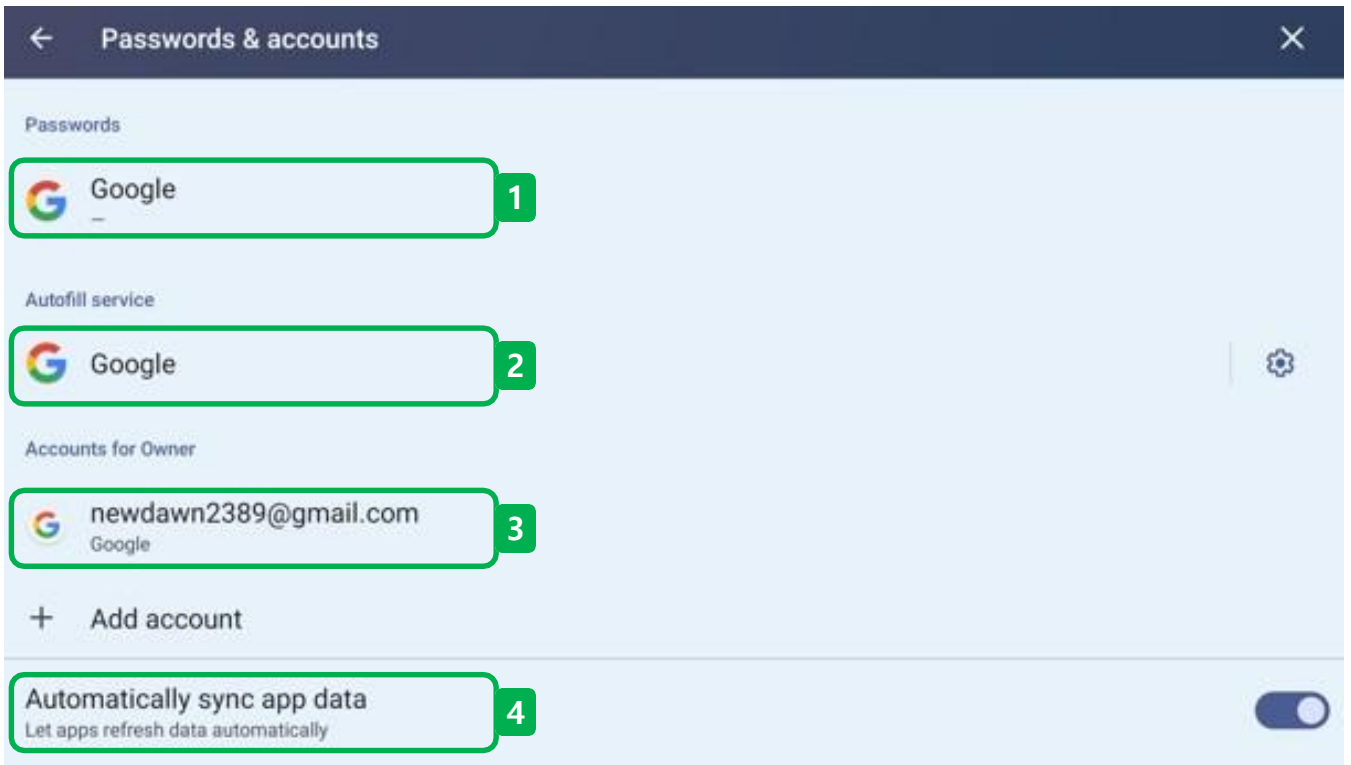

① Passwords

- Manage your saved passwords in your Google account

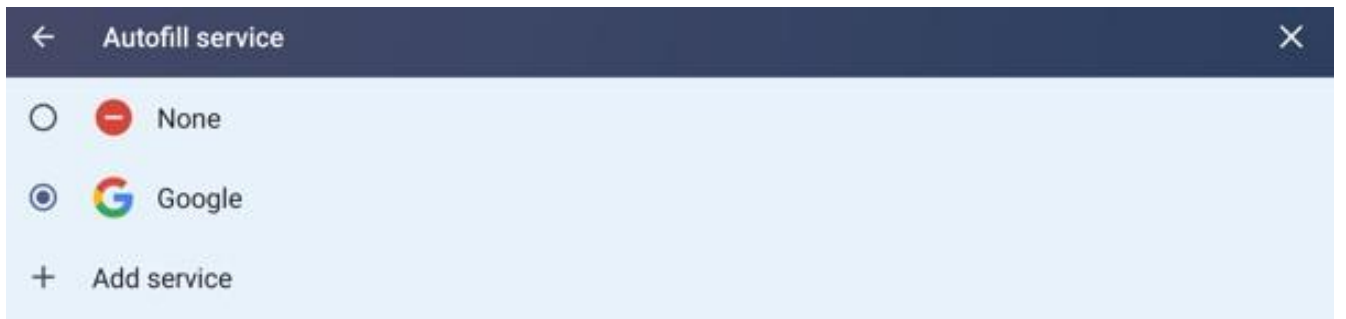

② Autofill service

- Add autocomplete functionality.

5.15 Passwords & accounts

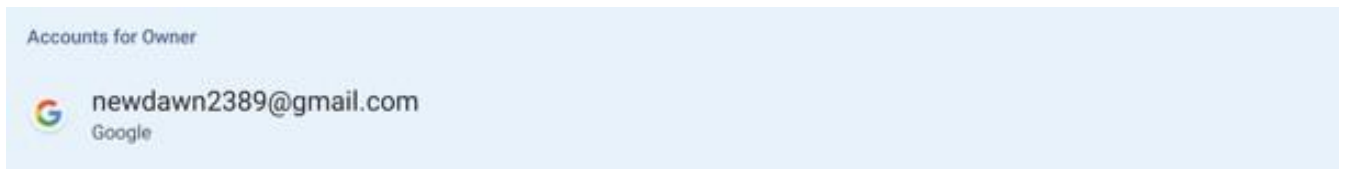

③ Accounts for owner

- You can view your currently registered google account, or add a new one.

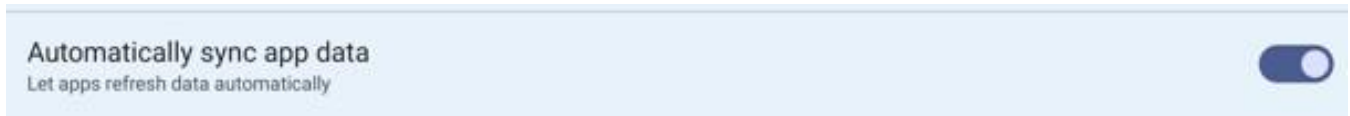

④ Automatically sync app data

- Enable / disable let apps refresh data automatically on the device

5.16 Digital wellbeing & parental controls

Digital Wellbeing & parental controls

Your Digital Wellbeing tools



Unlocks ①

19 Notifications

Ways to disconnect

Dashboard 1
No timers set

Bedtime mode 2
Tap to set up

Focus mode 3
Tap to set up

Reduce interruptions

Manage notifications 4

Do Not Disturb 5

Heads Up 6
Tap to set up

Show icon in the app list 7

Families

Parental controls 8
Add content restrictions and other limits to help your child balance their screen time

[Set up parental controls](#)

❖ Digital wellbeing & parental controls

- Manage to see the device usage history and manage kids' device use

5.16 Digital wellbeing & parental controls

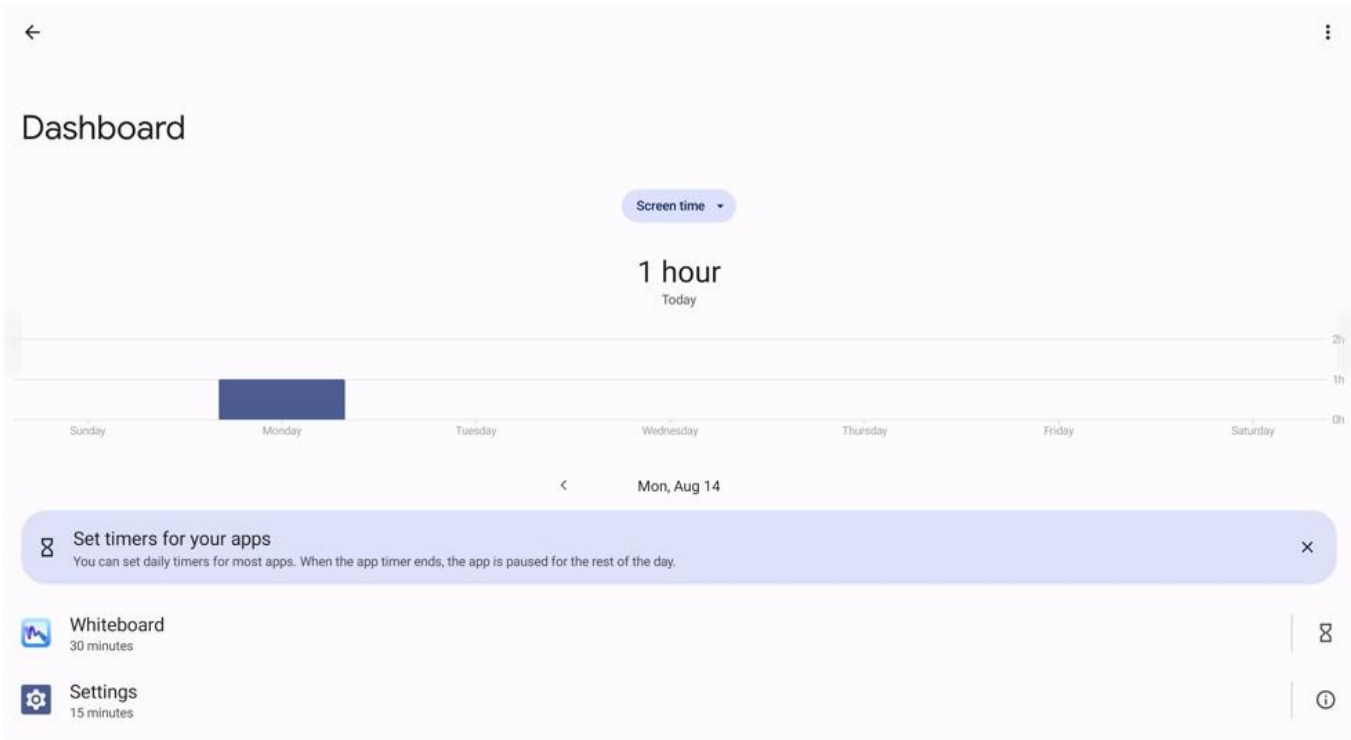

① Dashboard

- You can see the usage time of the apps on your device, and set a daily timer for each app so that when the set time is reached, the app stops for the rest of the day.

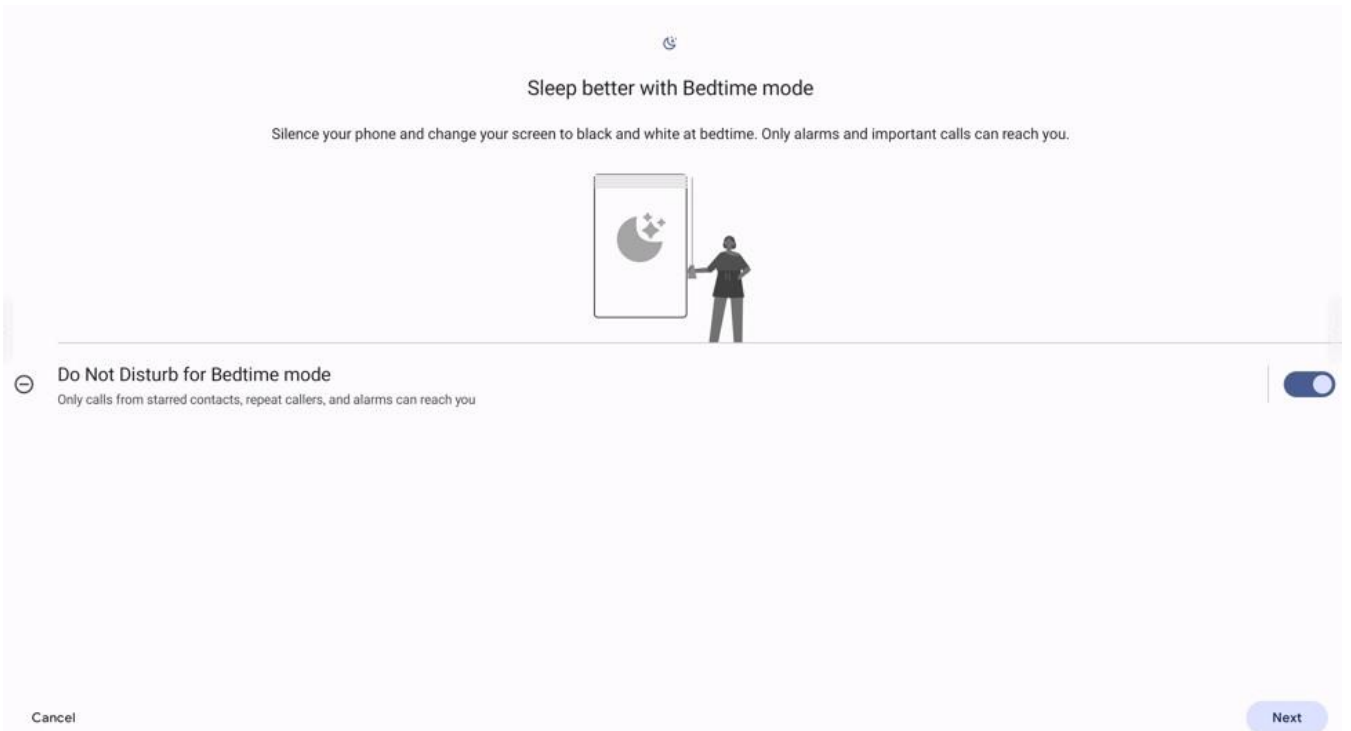

② Bedtime mode

- Mute your device and dim the screen brightness.
- Bedtime mode is available for calls and notifications from separately saved contacts and repeat callers

5.16 Digital wellbeing & parental controls



③ Focus mode

- Focus mode will also silence those apps' notifications until you're ready to switch out of the mode

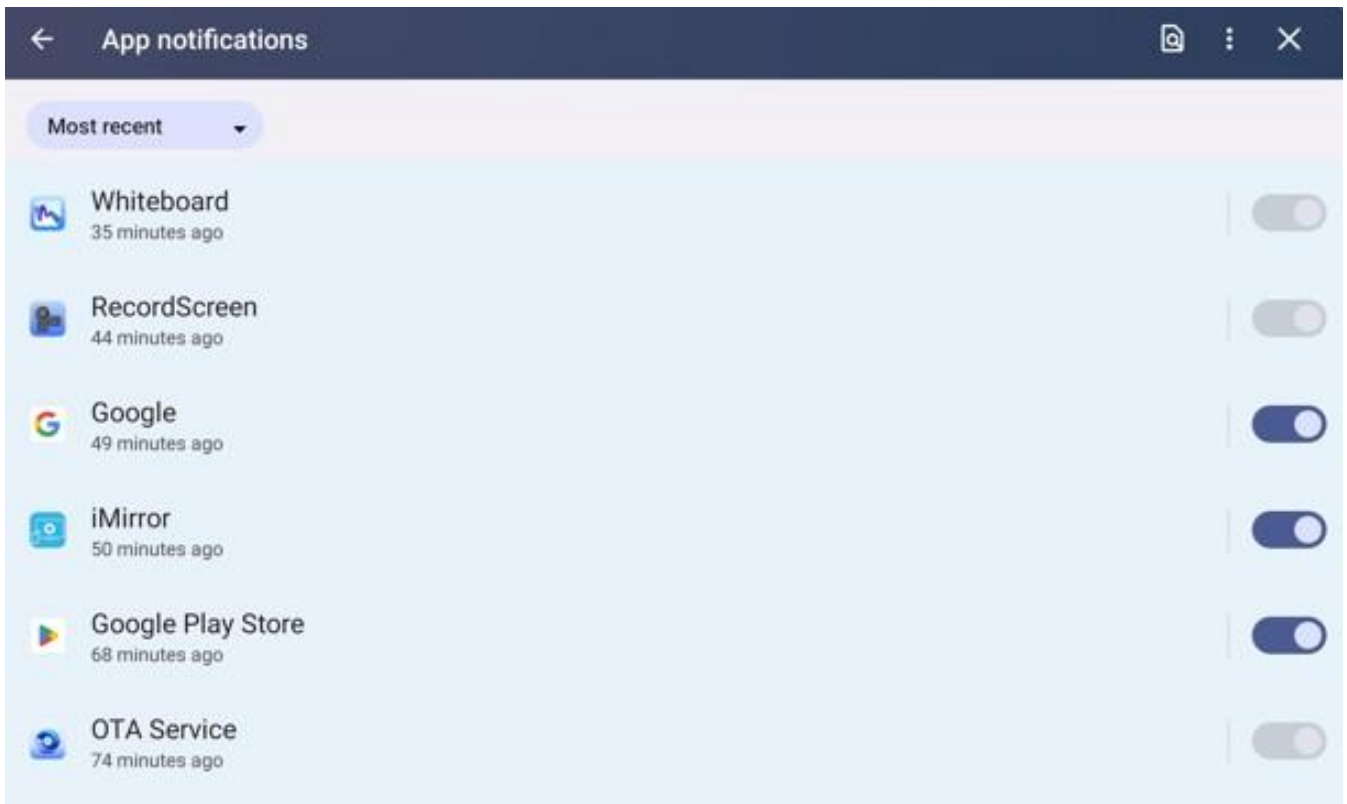

④ Manage notifications

- Enable/disable notifications for apps on your device.

5.16 Digital wellbeing & parental controls

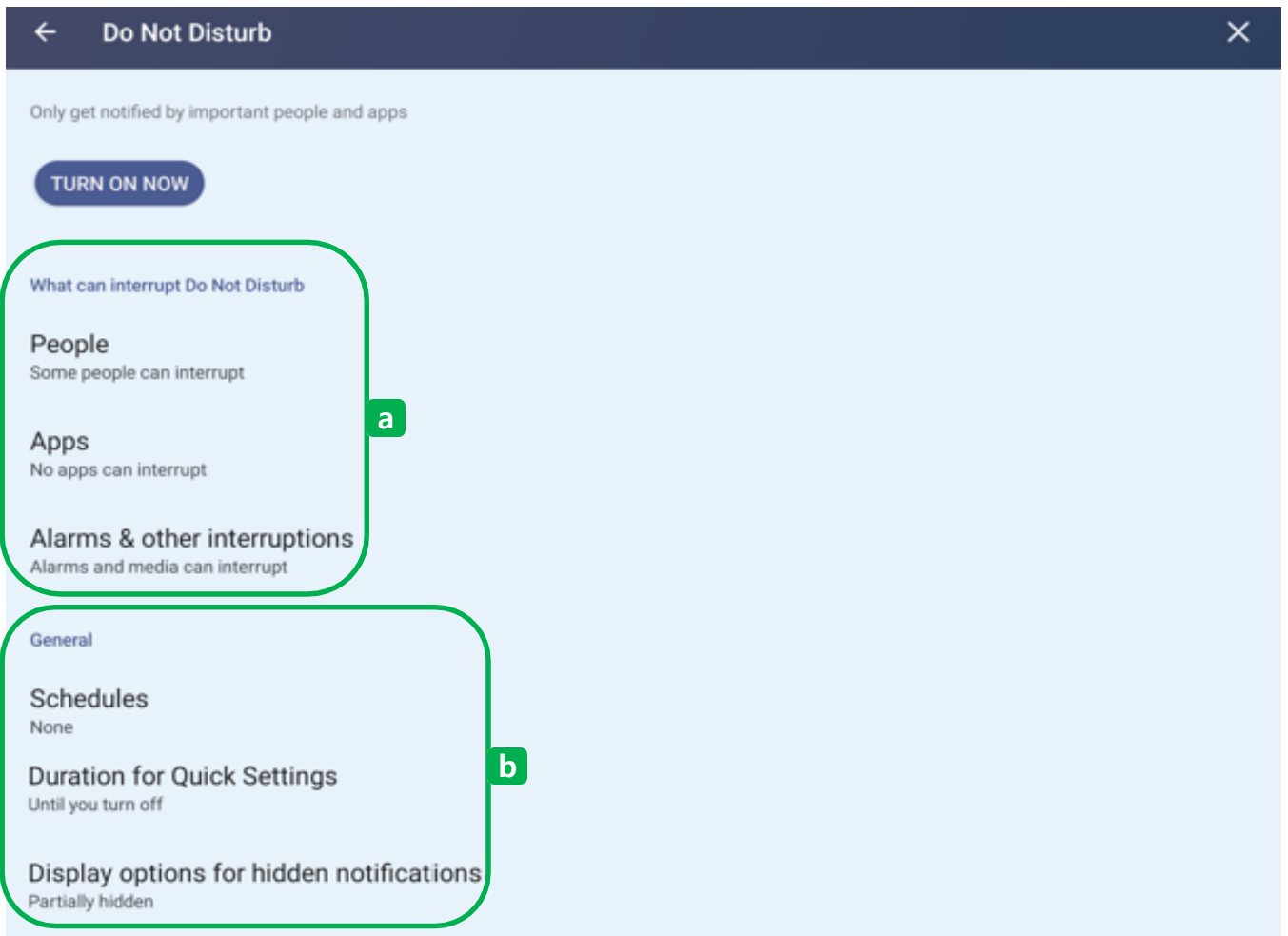

⑤ Do Not Disturb

- Enable/disable with Do Not Disturb

- You can receive separately designated apps, contacts, notifications, etc. even when Do Not Disturb is active.
- Schedule or manage the activation of Do Not Disturb by specifying a time.

⑥ Heads up

- Set to receive a caution notification when using the device while walking.

⑦ Show icon in the app list

- Shows the icon in the app list.

5.16 Digital wellbeing & parental controls

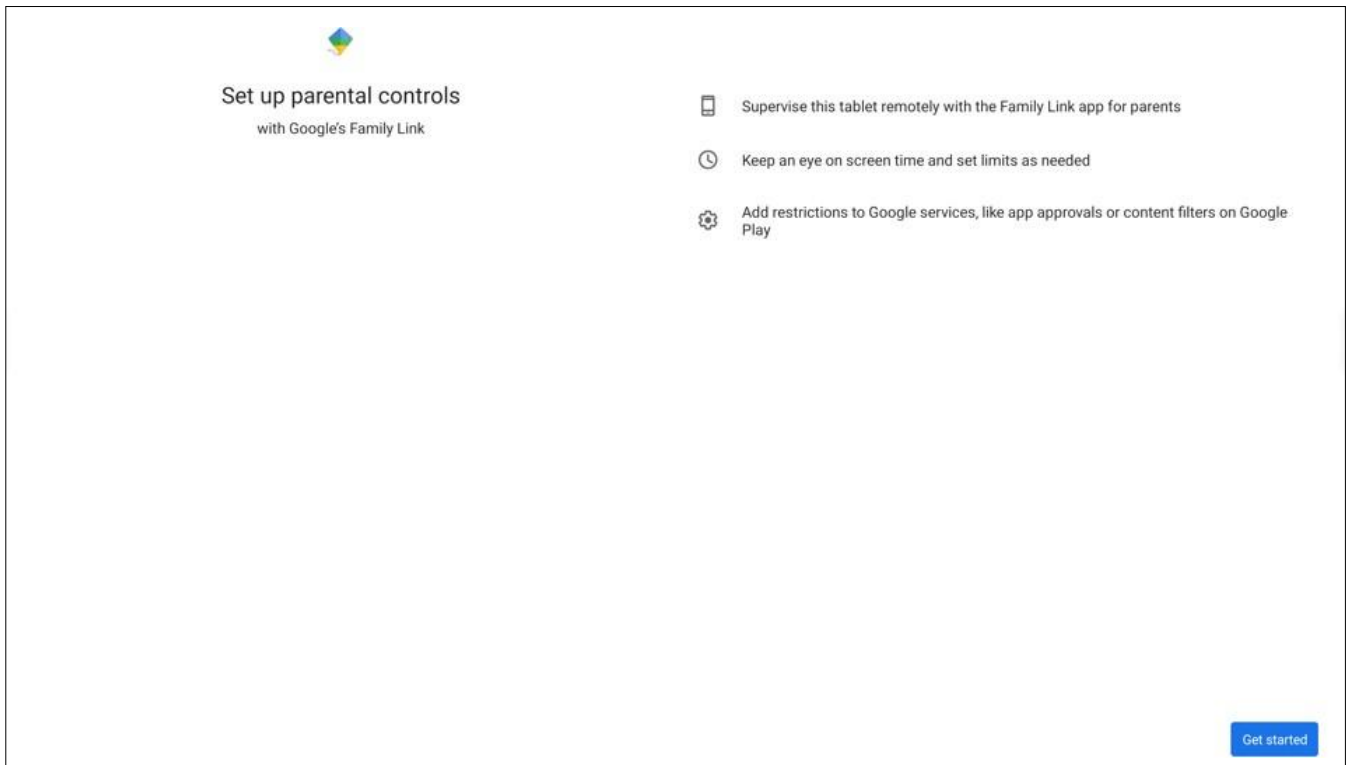

⑧ Parental controls

- You can manage this device remotely with a separate Family link app.
- You can manage your kids' device usage by restricting app and service approvals, and more.

5. System setting

5.17 Google

5.18

❖ Google

- You can manage your Google account, apps, backups, and many other related features.

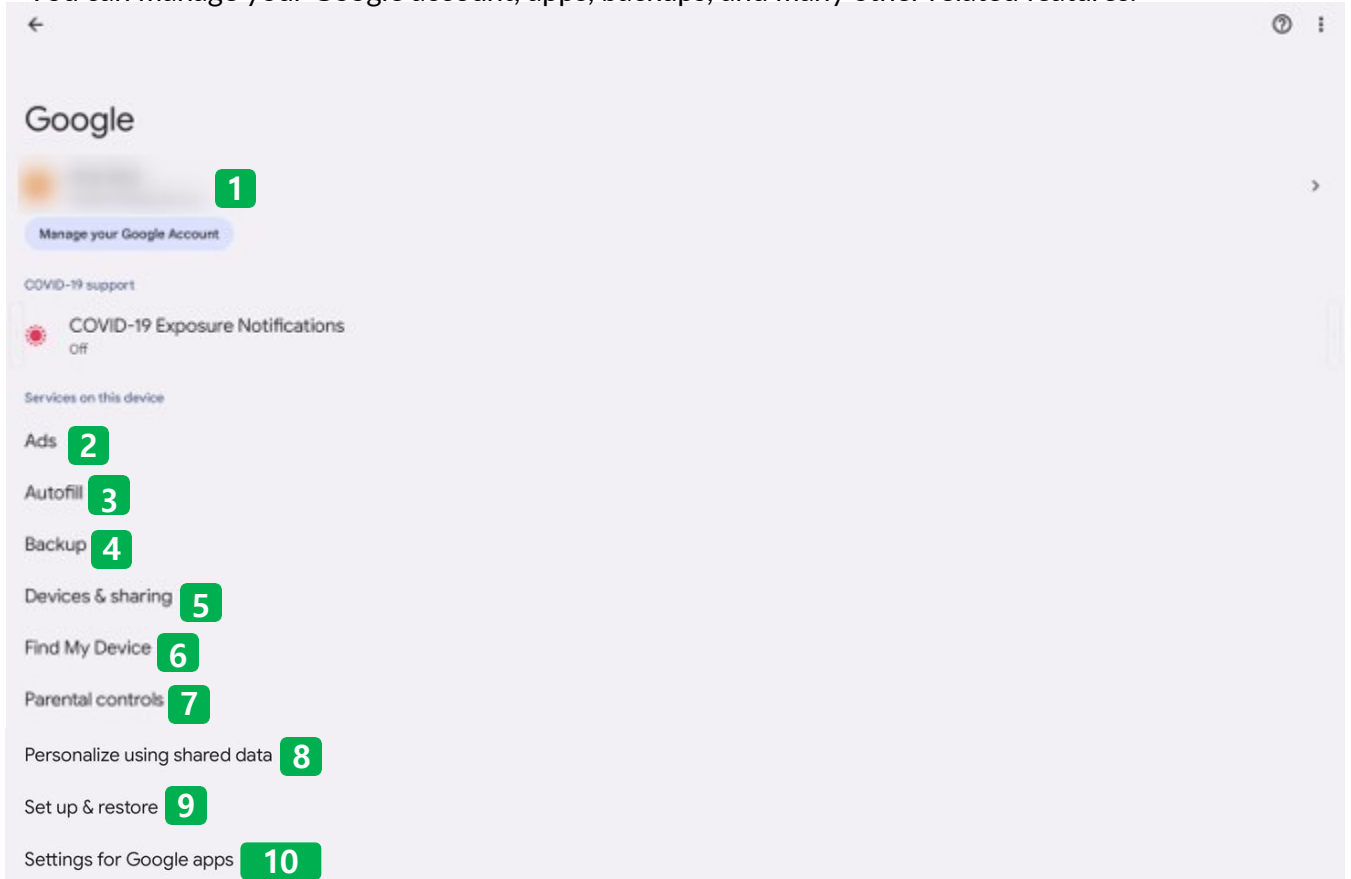

① Google account

- You can manage your google account logged into currently

5.17 Google

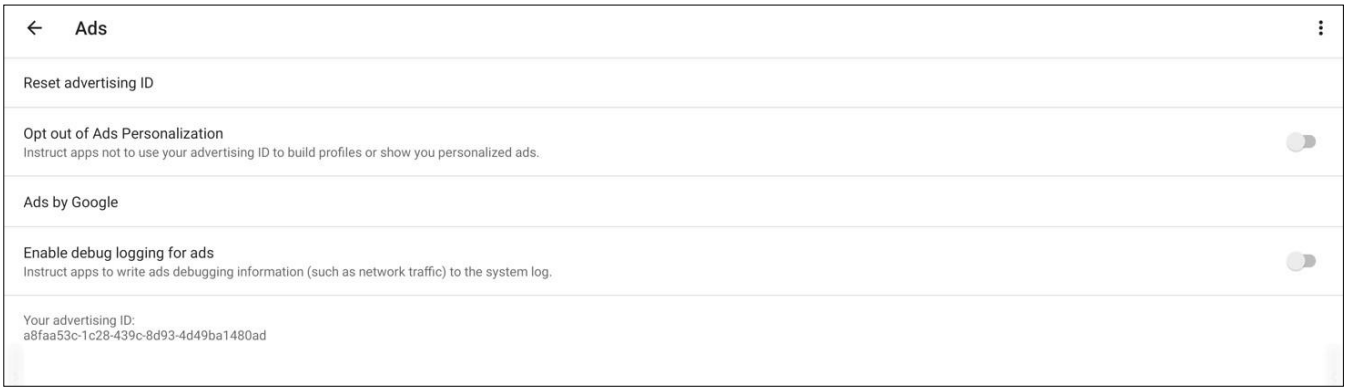

② Ads

- Manage Ads settings by Google

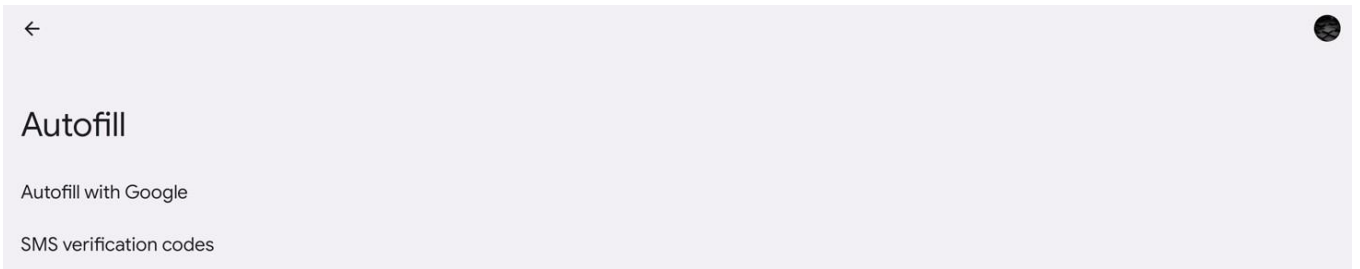

③ Autofill

- Manage the Google autocomplete feature.

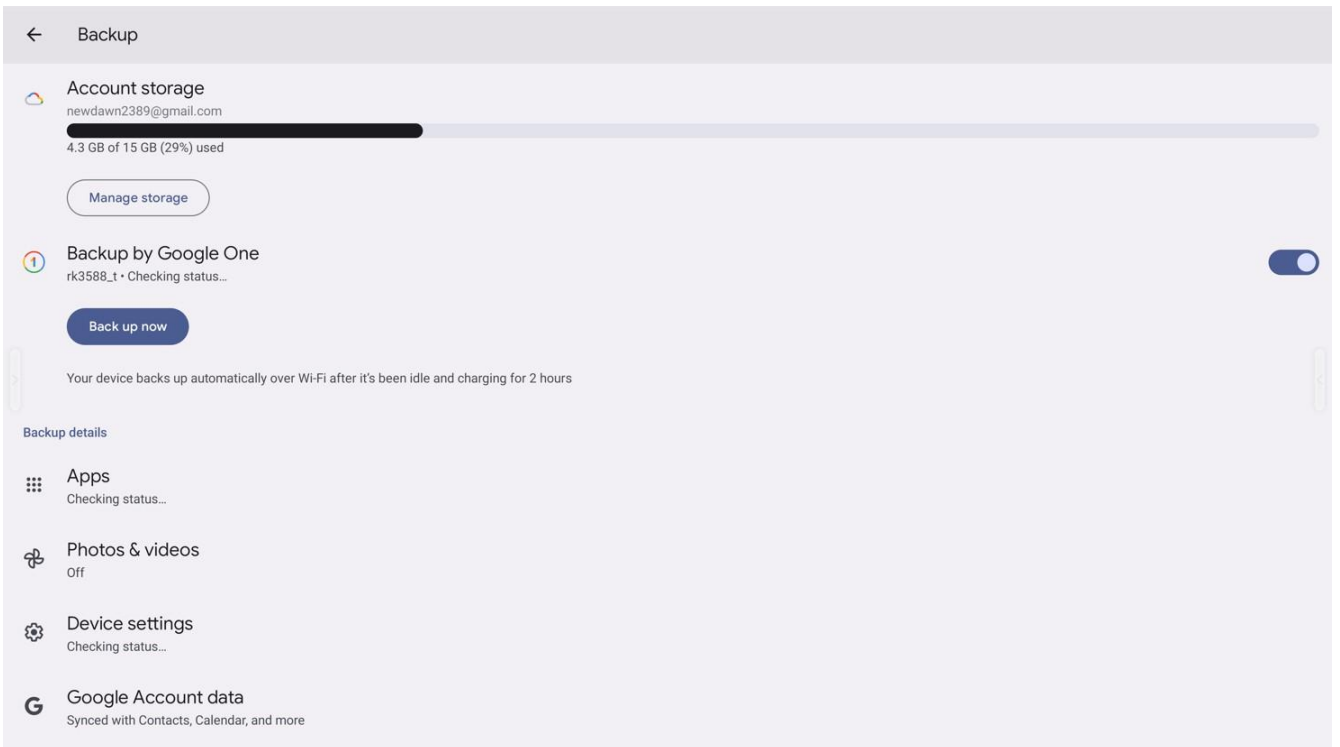

④ Backup

- Manage data backup, recovery, and more with your Google account.

5.17 Google

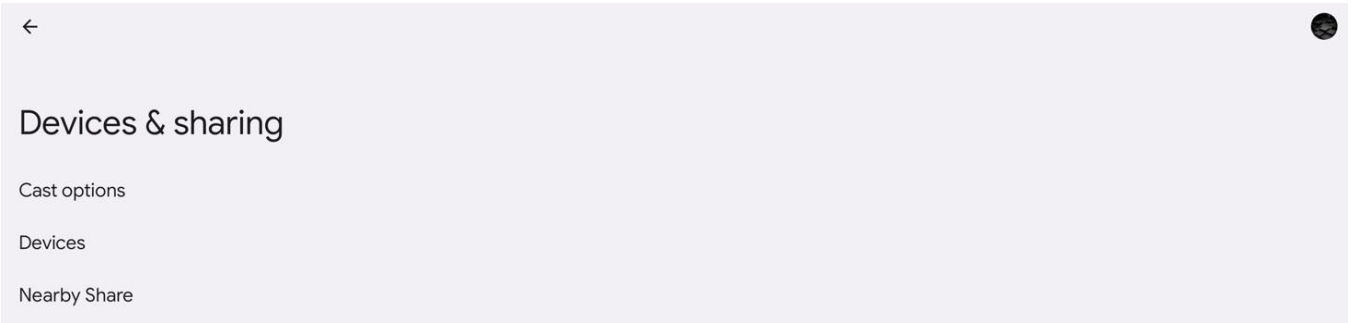

⑤ Devices & sharing

- You can share data, documents, photos, and more with nearby devices by using Wi-Fi, etc.

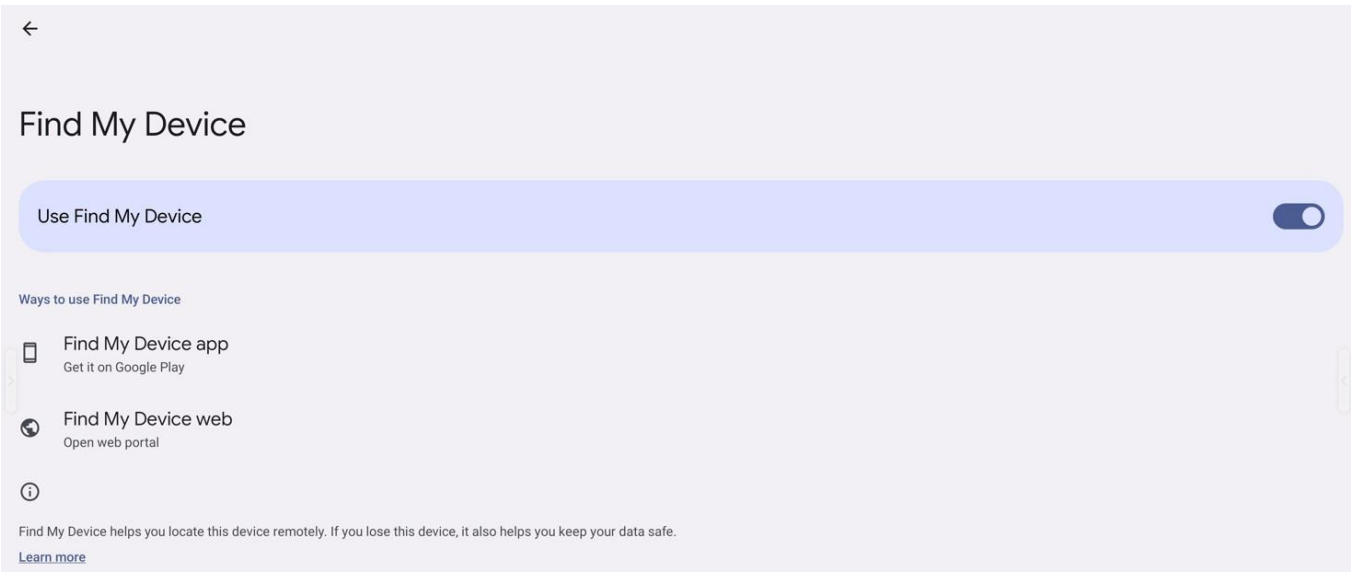

⑥ Find My Device

- You can find your devices connected to your Google account in the app or on the website

5.17 Google

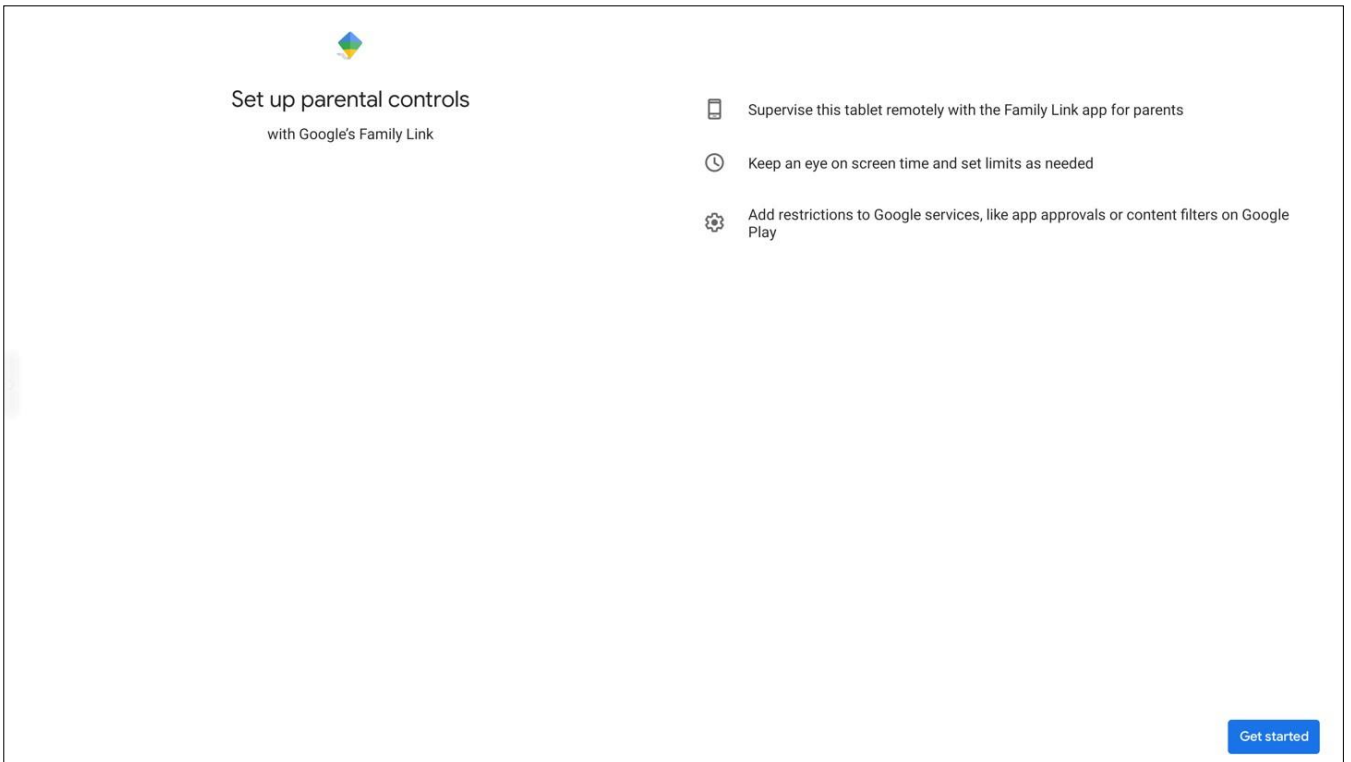

7 Parental controls

- You can manage this device remotely with a separate Family link app.
- You can manage your kids' device usage by restricting app and service approvals, and more.

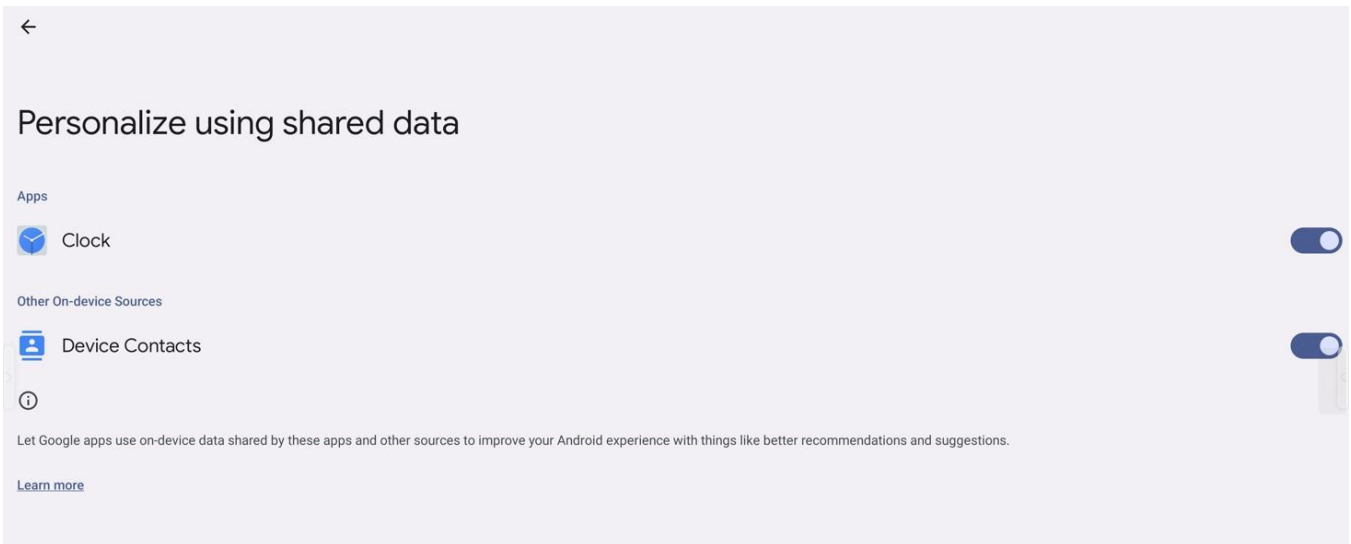

8 Personalize using shared data

- Google apps share data with other apps on your device to make your Android experience better with recommendations and suggestions.

5.17 Google

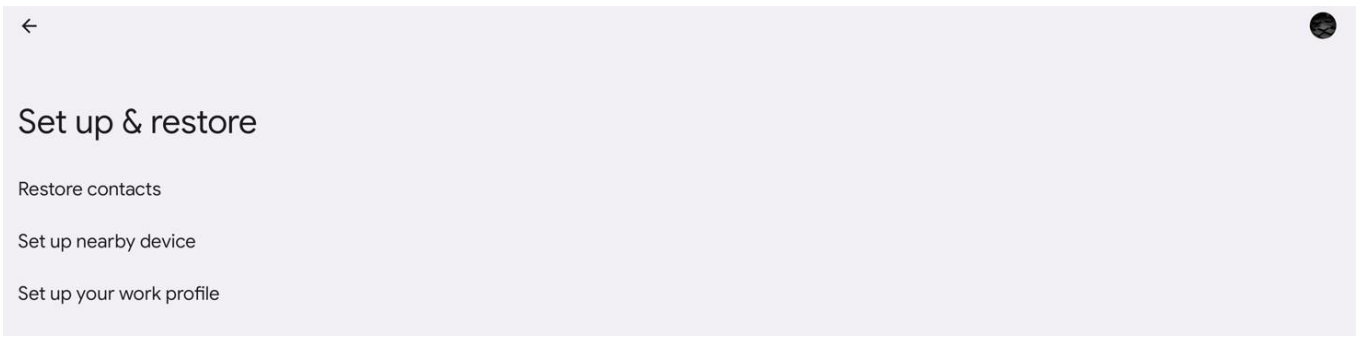

⑨ Set up & restore

- Manage the setup and restoration of Google data on your device.

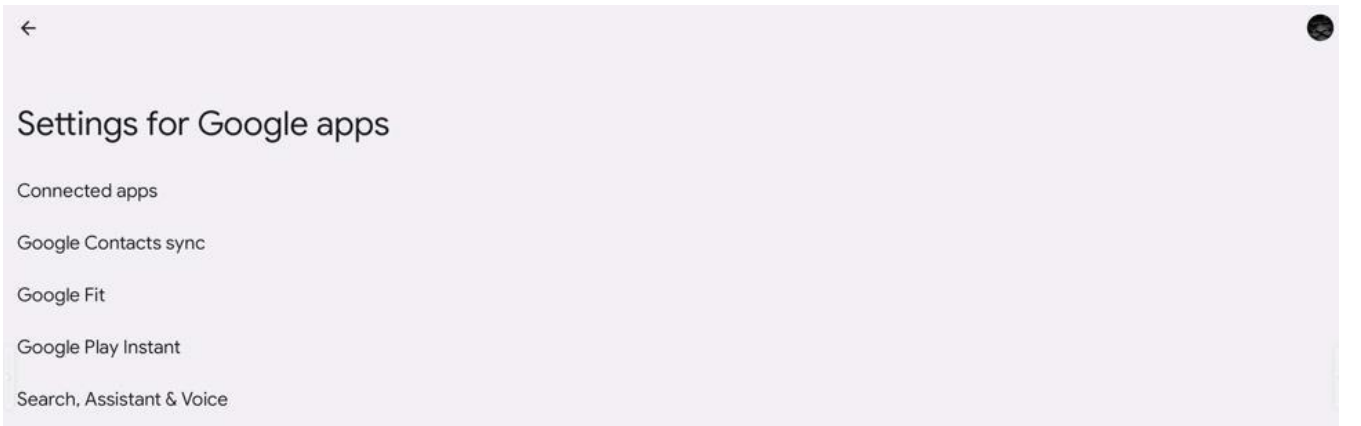

⑩ Settings for Google apps

- Manage settings related to the integration of Google apps.

5.19 System



❖ System

- Manage settings for data, language, time, backups, and more on your device.

5.18 System

5.18.1 Language & input

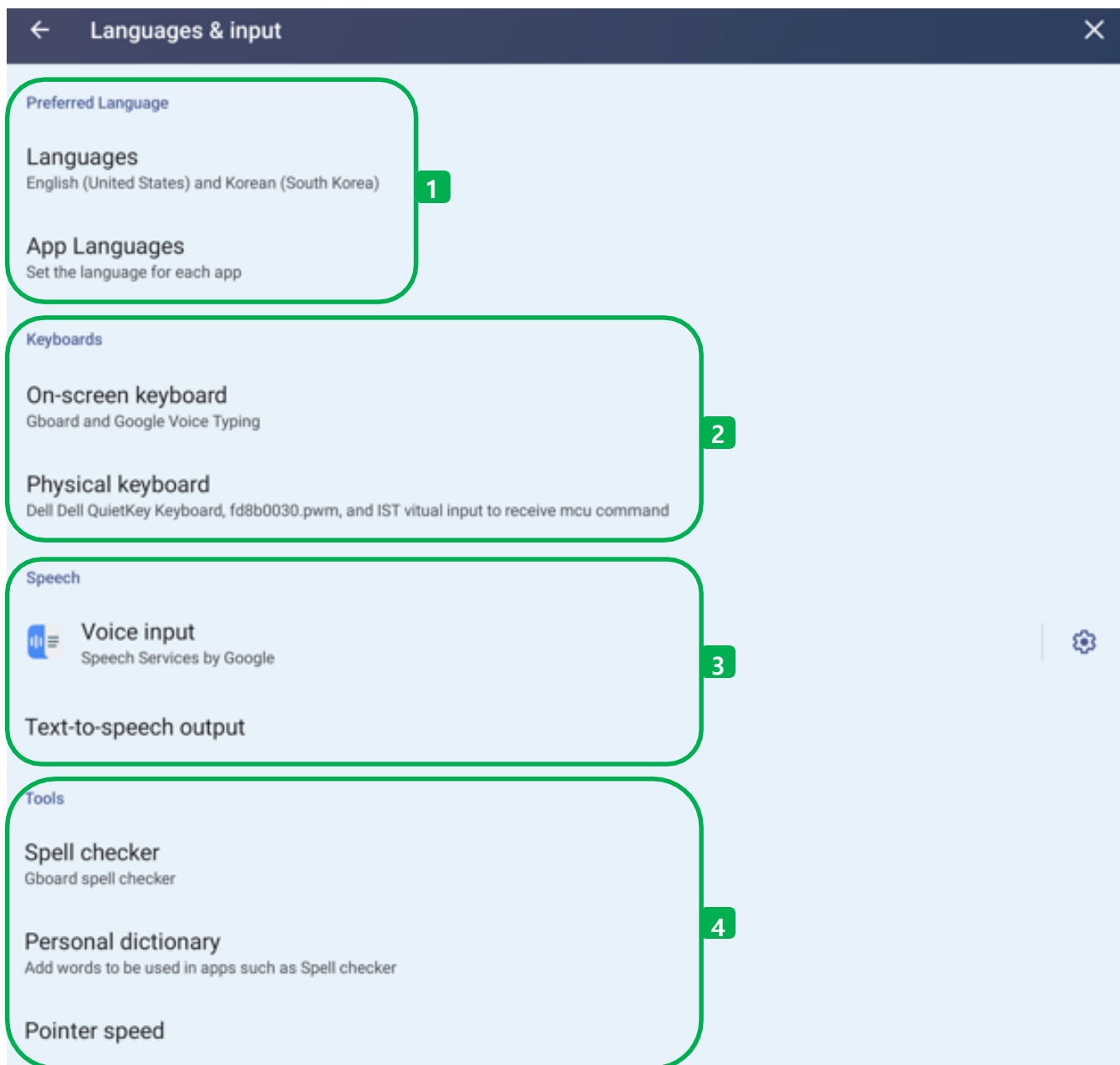

① Preferred language

- Languages: Allows users to freely change the UI language on the device.
- App languages: Users can freely change the app language on their device.

② Keyboards

- On-screen keyboard: Manage settings such as language, layout, and more for the touch keyboard.
- Physical keyboard: Manage settings such as language, layout, and more for the physical keyboard.

5.18 System

③ Speech

- Voice input: A voice service feature supported by Google.
- Text to speech output: Manage other settings such as the language of the speech service, speaking speed, and more.

④ Tools

- Spell checker: Use Gboard's spell checker.
- Personal dictionary: You can add terms to your personal dictionary by pressing the +Add button.
- Pointer speed: Changes the speed of the pointer function.

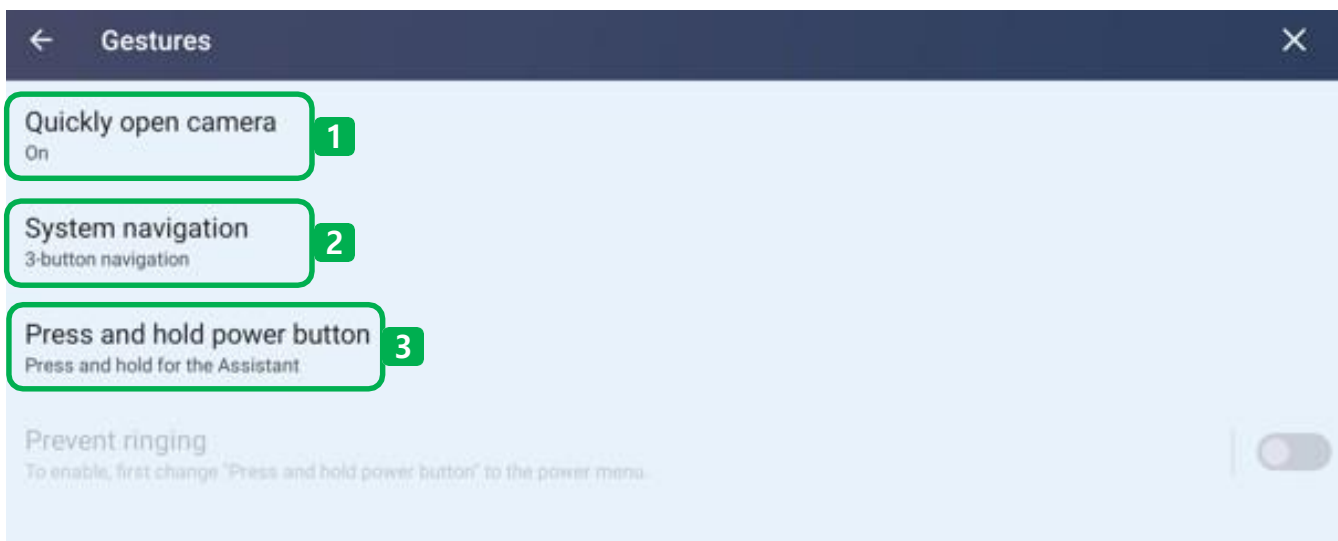

5.18.2 Gestures

① Quickly open camera

- You can open the camera immediately by quickly pressing the power button twice.

② System navigation

- You can choose to use gestures or 3-button navigation for functions like going home and going back.

③ Press and hold power button

- You can launch the Assistant by pressing and holding the power button.

5.18 System

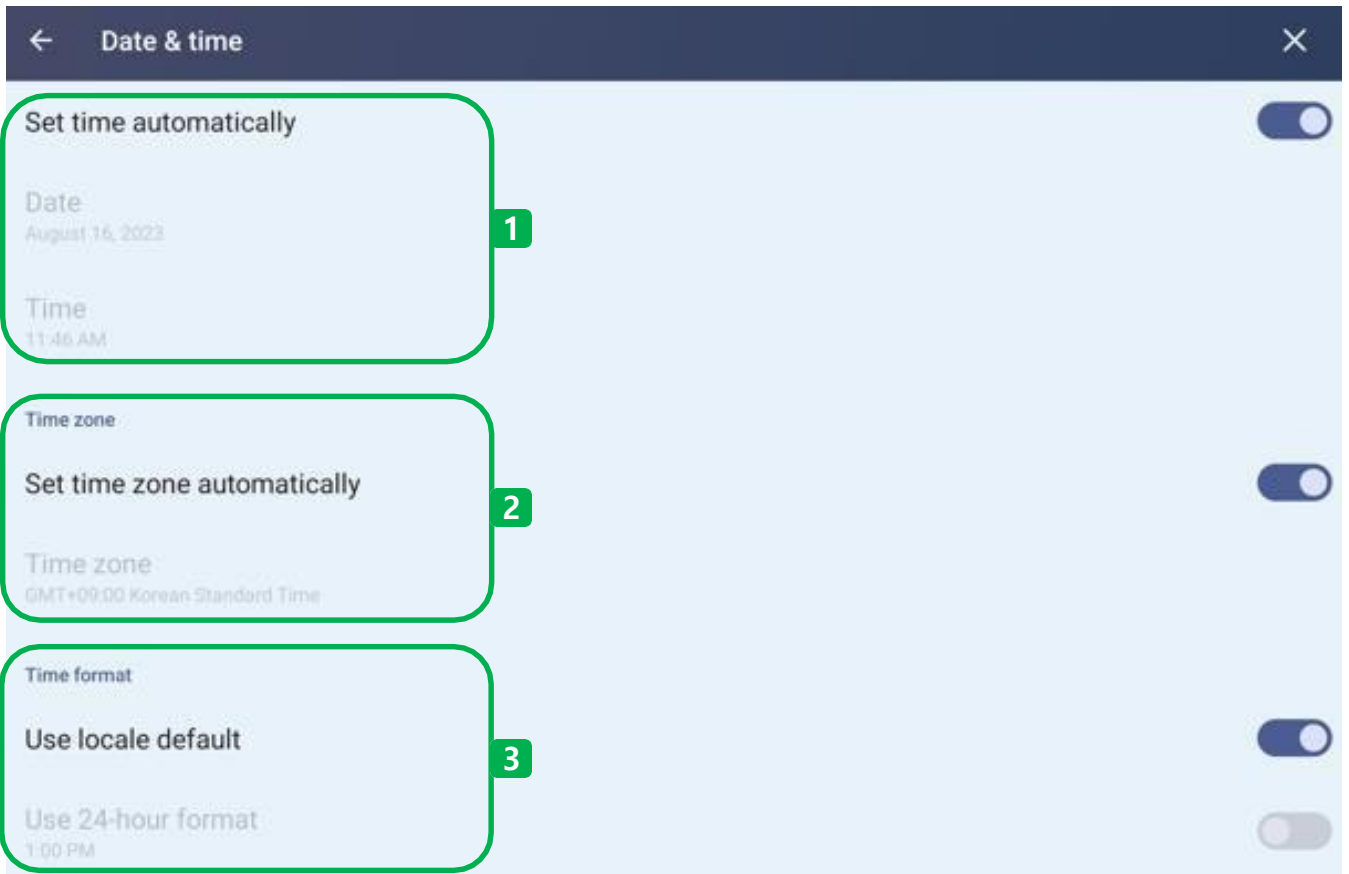

5.18.3 Date & time

① Date & time setting

- You can set the date and time automatically or manually.
- An internet connection is required to use automatic features.

② Time zone

- You can set the world time zone automatically or manually.
- An internet connection is required to use automatic features.

③ Time format

- You can set the current time representation format to AM, PM, or 24 hours.

5.18 System

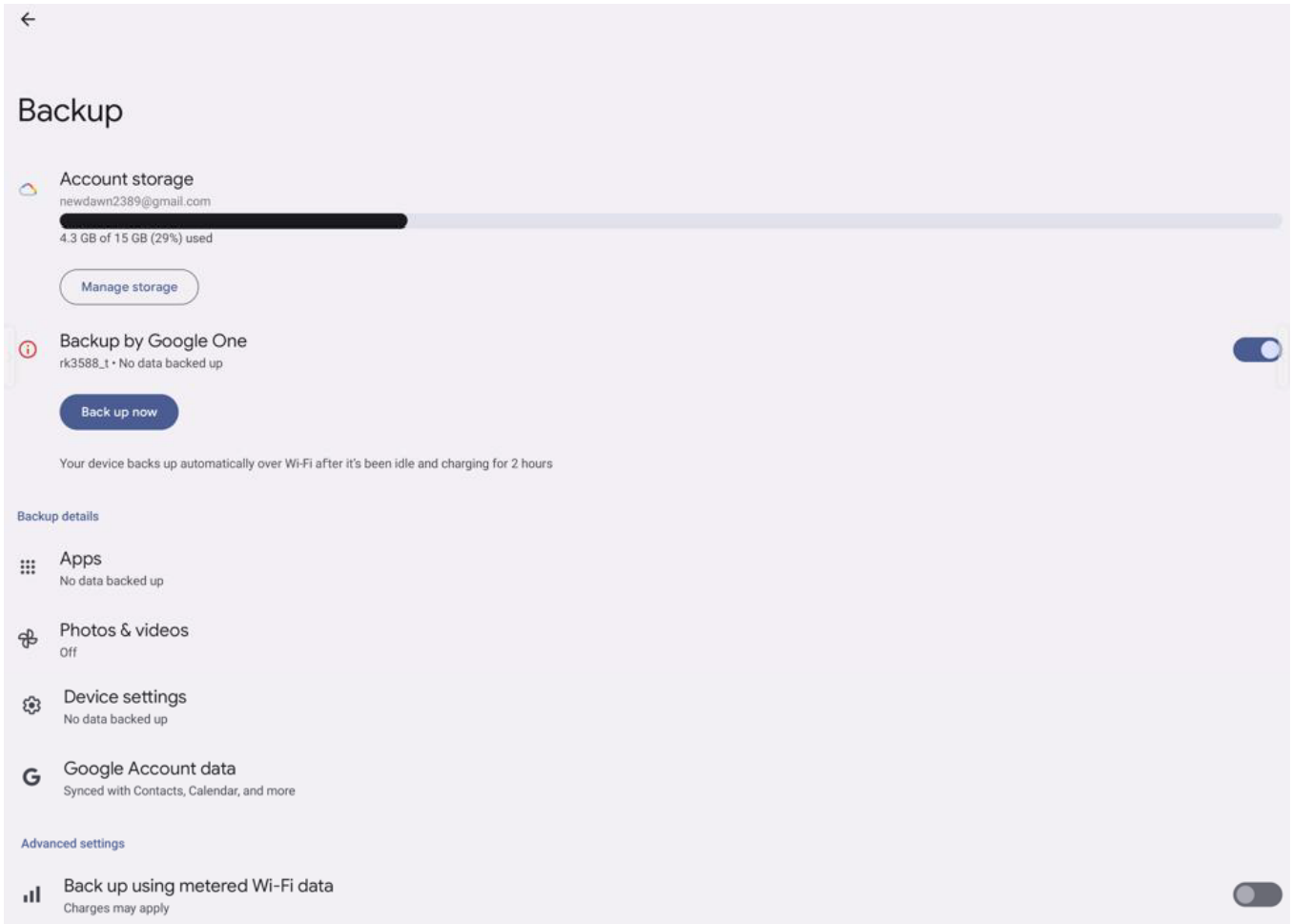

5.18.4 Backup

① Backup start

- You can back up data within your device.

② Backup detail

- It allows you to backup individual items on your phone, such as apps, pictures and more.

5.18 System



5.18.5 System update

- You can find your device's Android version, update date and more. And you can upgrade latest version.

5.18 System

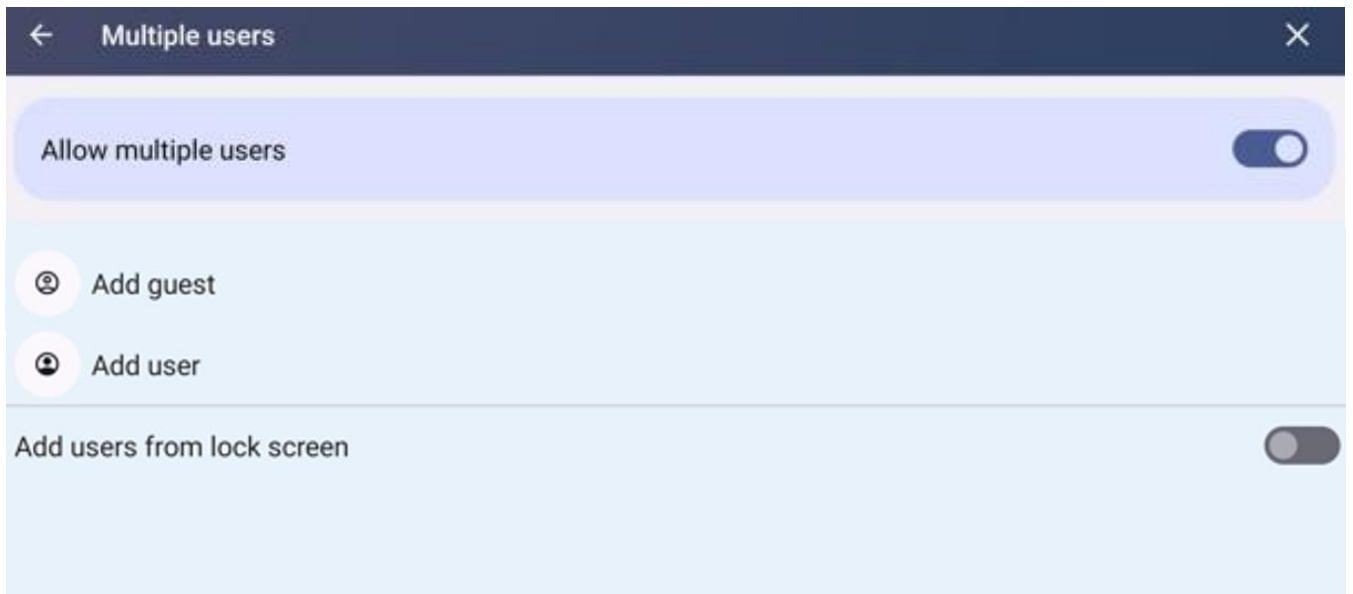

5.18.6 Multiple users

- You can see the users on the device, and you can also allow multiple users, you can start adding and managing users.

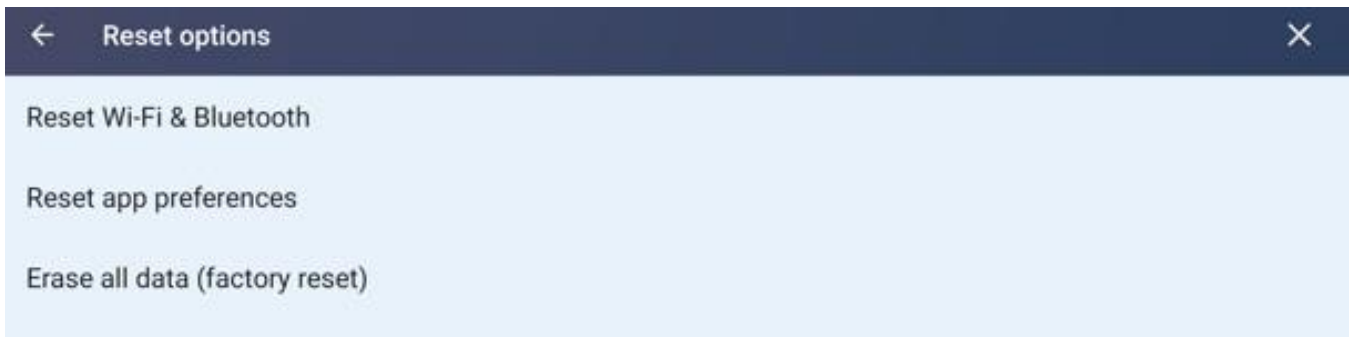

5.18.7 Reset options

- Reset your device's preferences, erase all data, and more to factory reset

5.20 About device



❖ About device

- You can see the device name, Android version, and IP addresses.
- You can see the firmware version and proceed with the upgrade.

6. Whiteboard

6.1 Main Screen

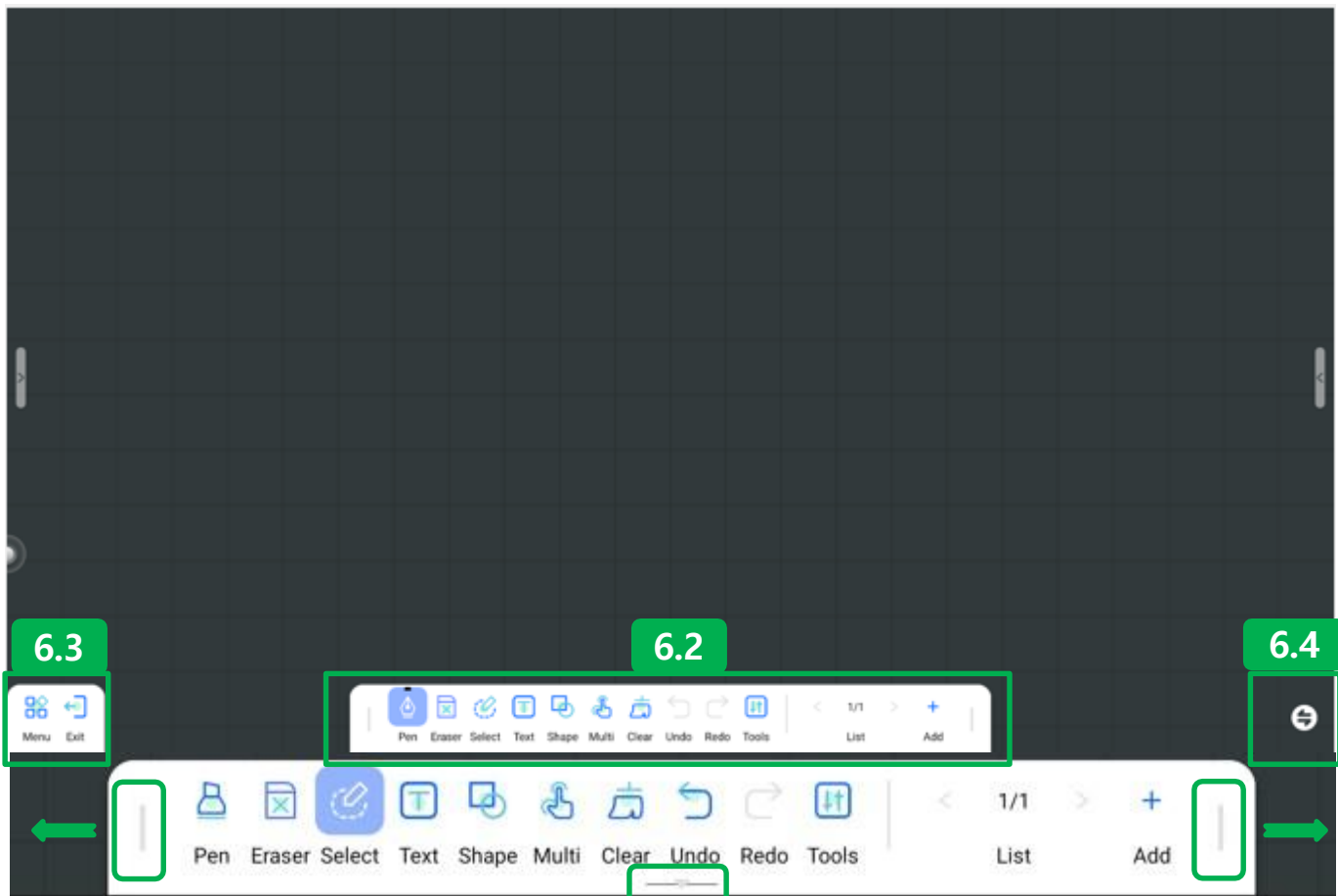

6.2 Writing toolbar

6.2.1 Moving the toolbar

- You can drag and drop toolbar button onto the left or right side.
- You can hide the toolbar by pressing the bottom button.

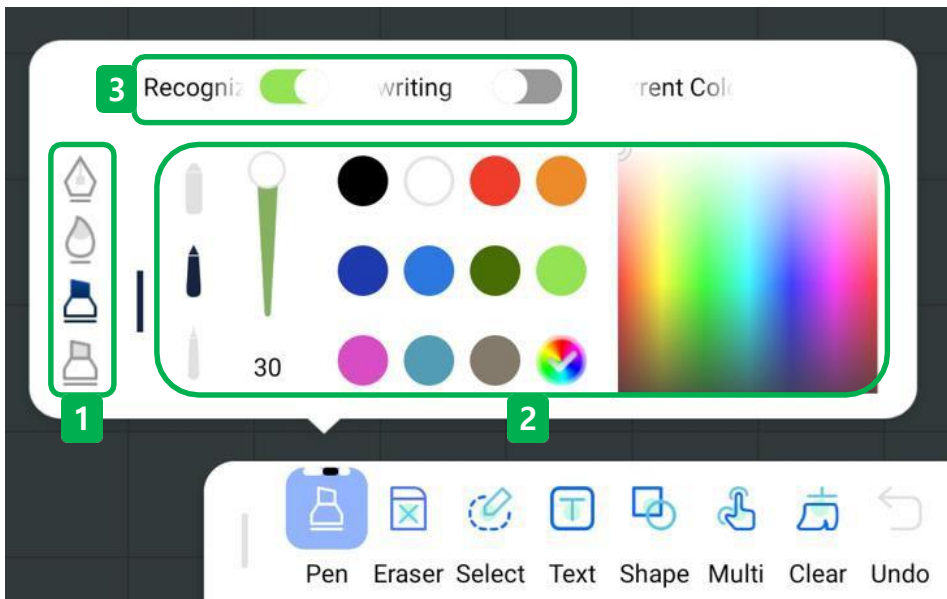

6.2.2 Pen

- You can freely change the type, thickness, and color of the pen.

① Pen type

- There are four types of pens: fountain pen, brush pen, marker pen, and highlighter.

② Setting for Pen's thickness recognition

- You can use three pens concurrently, each with its own touch sensitive boldness.

- S(Small Finger) : 2.8mm, B(Big finger) : 6.5mm, F(Stylish big finger) : 10mm

- You can adjust the boldness which can be adjusted from 1 to 30.

- You can freely assign colors to each pen's on the Color board.

③ Recognition function

- Automatically recognize the shape of handwriting with a pen and turn it into a shape or text. (Select and use either Shape recognition or Text recognition).

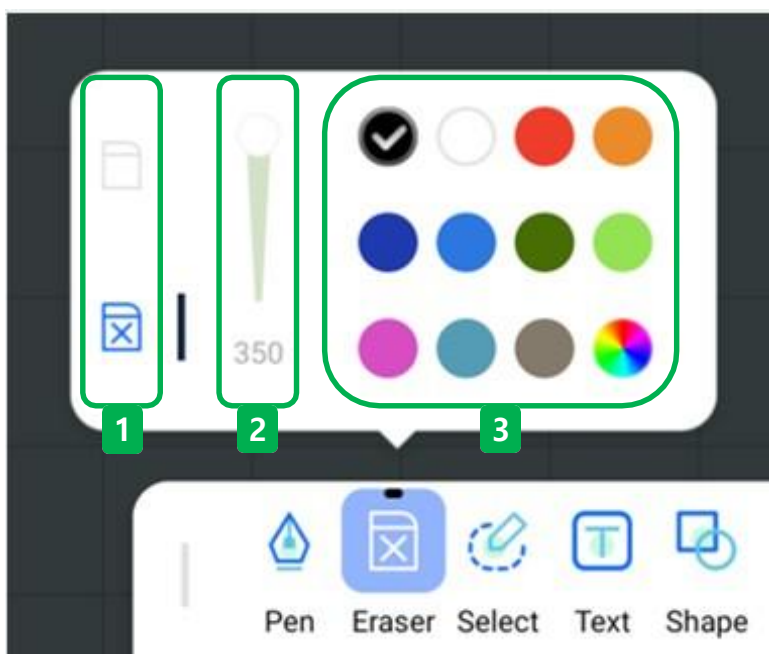

6.2.3 Eraser

- You can freely change the type of eraser, size, color selection and more..

① Types of eraser



<Default>



<Select>



<Gesture>

- There are three types of erasers: default, selection, and gesture.
- Default: This is a resizable eraser that can be customized from 100 to 350.

- Select: You can erase by selecting the objects you want to erase, and you can erase give them a color of your choice.
- Gesture: Recognizes the palm of your hand or a large object and acts as an eraser, even while selecting other functions of the tool is available.

② Resize the eraser

- The eraser is resizable, and can be adjusted from 100 to 350.
(This feature only works with the default eraser).

③ Erase of selected color

- Specify the color of the writing the user wants to erase so that the eraser only works with the specified color.
-  This color makes the eraser function work on all colors.
(This feature only works in the Selection Erase).

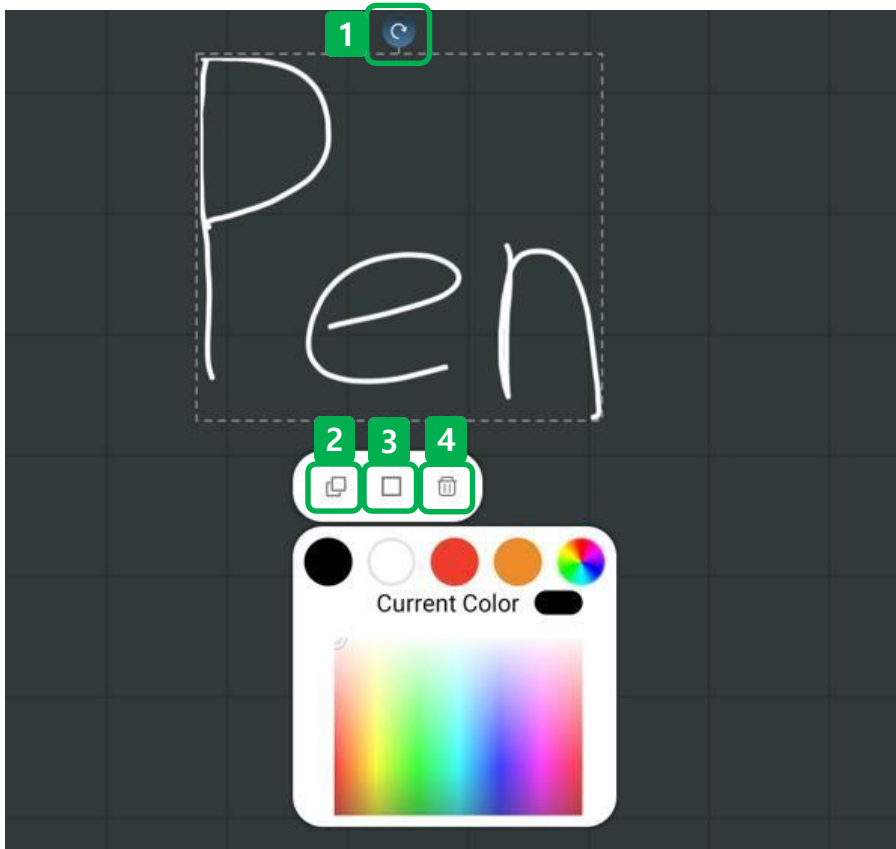

6.2.4 Select

- Select an object to modify it by copying, deleting, rotating, and more.

① Rotate objects

- Rotates the selected object.

② Copy objects

- Copies the selected objects.

③ Object color

- Modify the color of selected objects.

④ Delete object

- Deletes the selected objects.

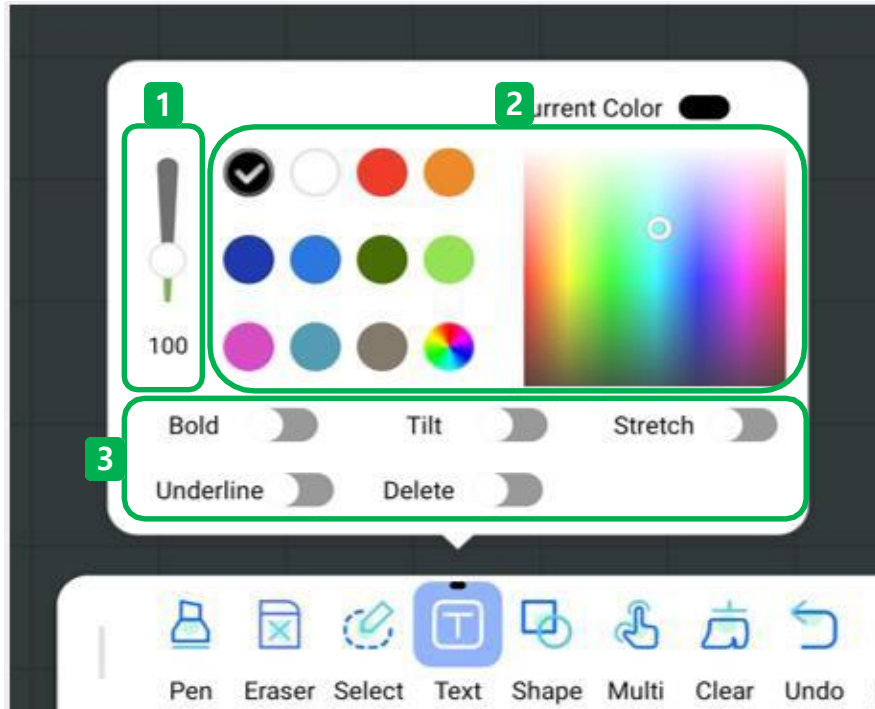

6.2.5 Text

- You can freely change the size, font, color and more of the text.

① Resize text

- Text is resizable, and can be scaled from 60 to 200.

② Adjust the color of the text

- You can use any text color you want on the Color board.

③ Adjust the text font

- You can adjust and use the font of the Text..

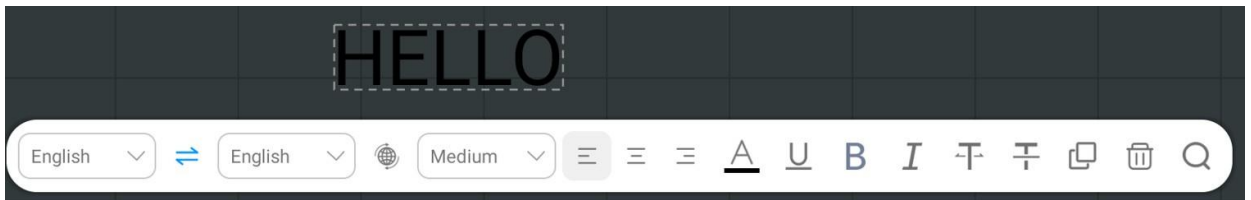

④ Make other edits to the text

- Once the text is loaded, you can select it to modify it with alignment, size, underline, and other features.

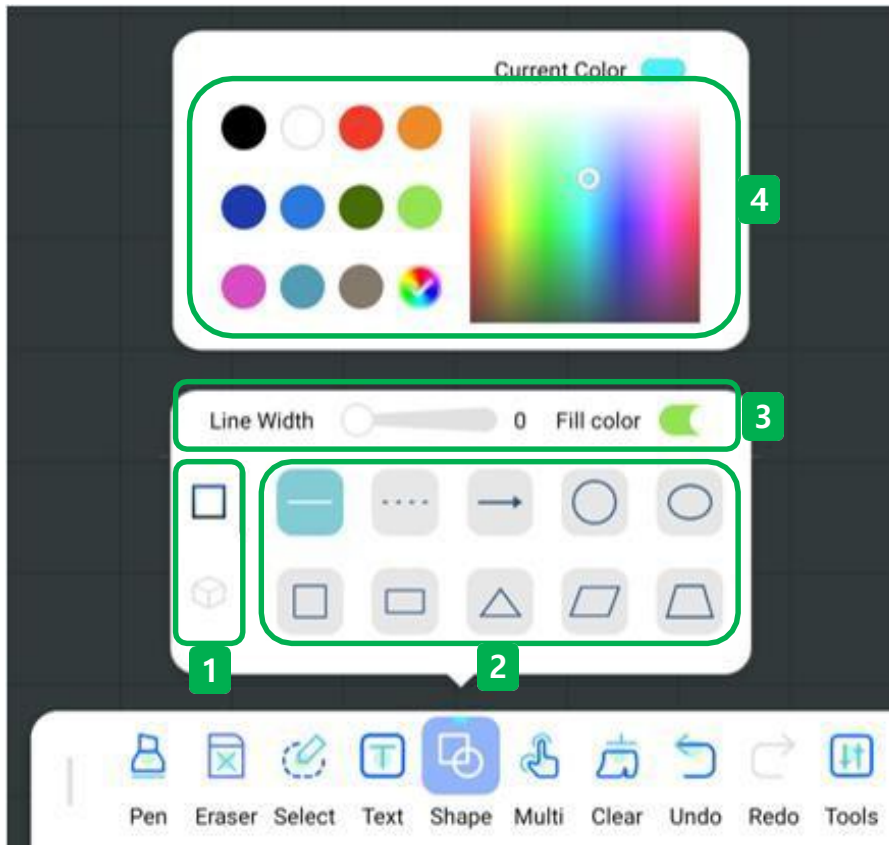

6.2.6 Shape

- You can freely change the type, color, size and more of the Shape.

① Shape type

- There are two types of Shapes: 2D and 3D shapes.

② Specify a shape

- Users are free to use any shape they want on the Shape board.
(You just select either 2D or 3D before using this Shape).

③ Adjust the thickness of the shape

- Line width : Allows you to adjust the thickness of the Shape, which can be adjusted from 0 to 25.
- Fill color: Available by specifying whether to fill the inside of the Shape or not.
(This feature only works in 2D Shapes).

④ Adjust Shape color

- You are free to use any Shape color you want on the Color board.

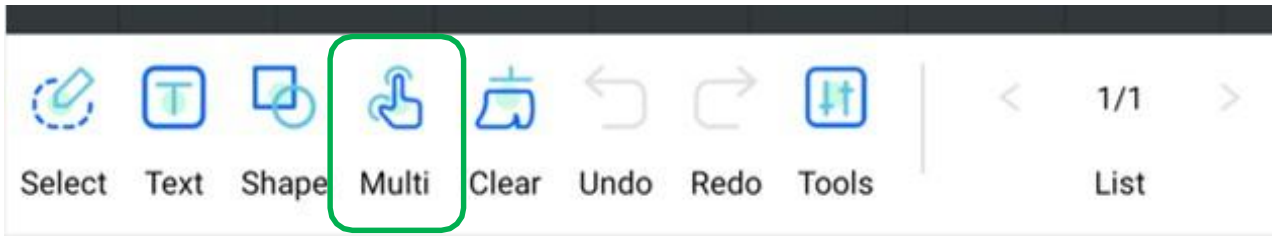

Multi



Single

6.2.7 Multi & single touch

- You can adjust the number of touchable points when using the white board.

① Multi touch

- Adjust the number of touchable points to allow for a range of 1 to 40.

② Single touch

- Adjust the number of touchable points to allow only one.

- 2point : Adjust the scale of the White board.

- 3points or more: Move everything on the White board.

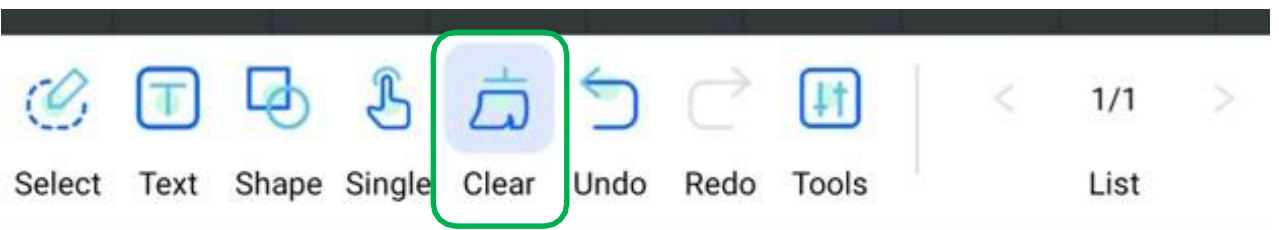

6.2.8 Clear

- Erases all the writing and everything on the White board at once.

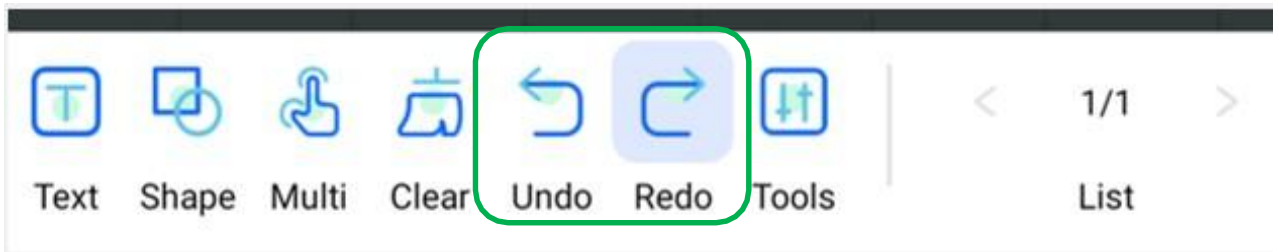

6.2.9 Undo & Redo

- Undo: Undoes the most recent touch.
- Redo: Recovers the most recent touch.

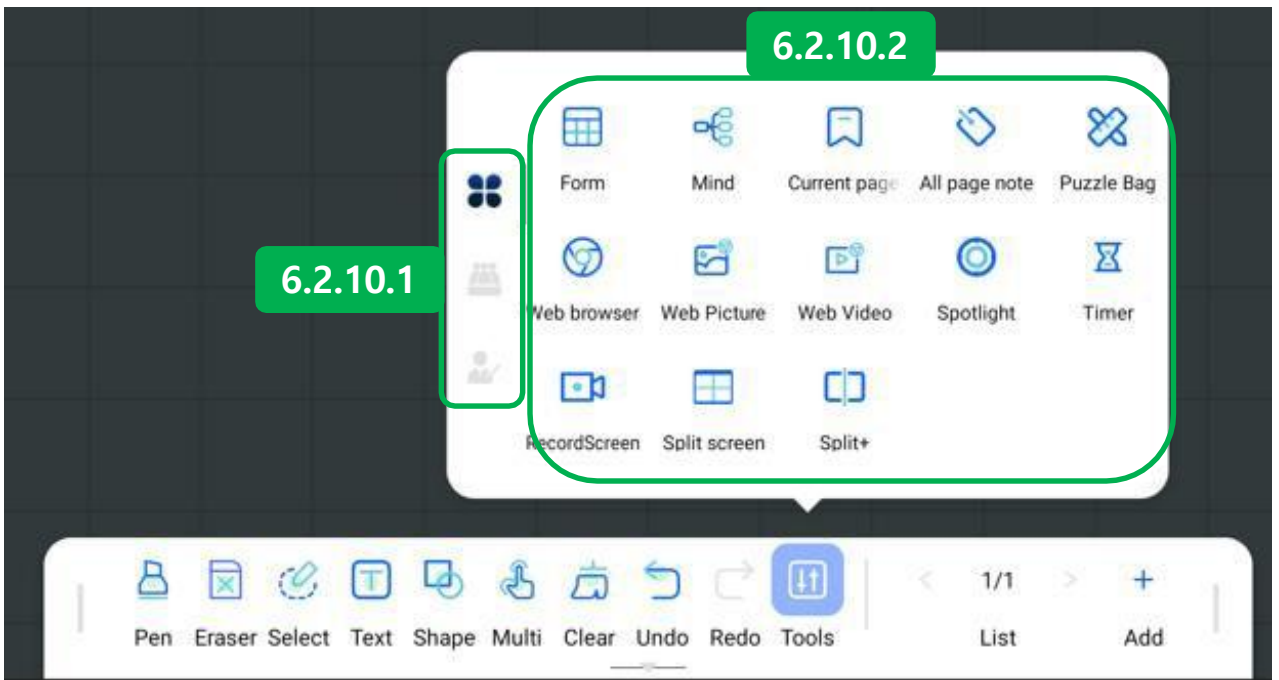

6.2.10 Tools

- You're free to pick and choose the tools you need for meetings and training."

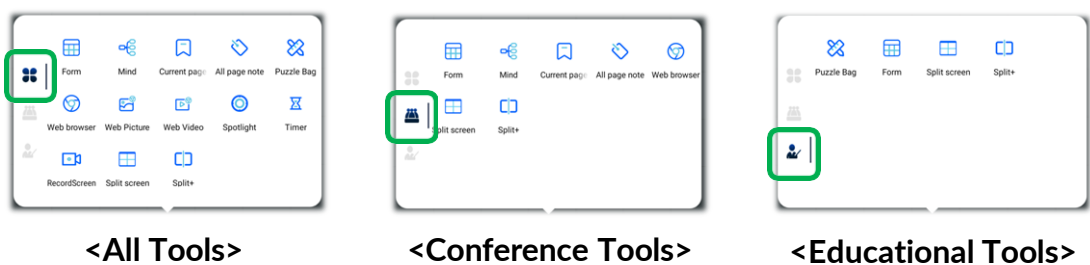

6.2.10.1 Tool Types

- All Tools: The full suite of tools for meetings and educational are available.
- Conference Tools: Conference tools are available.
- Educational Tools: Educational tools are available.

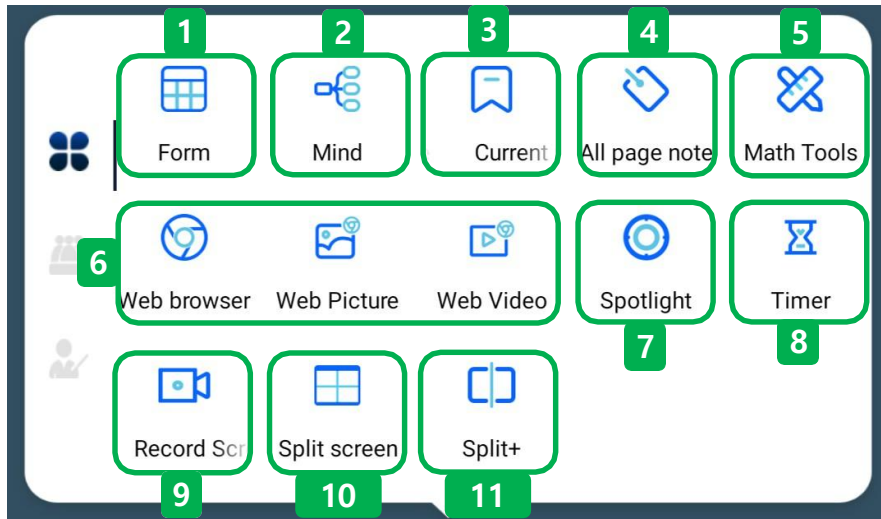

6.2.10.2 Tools option

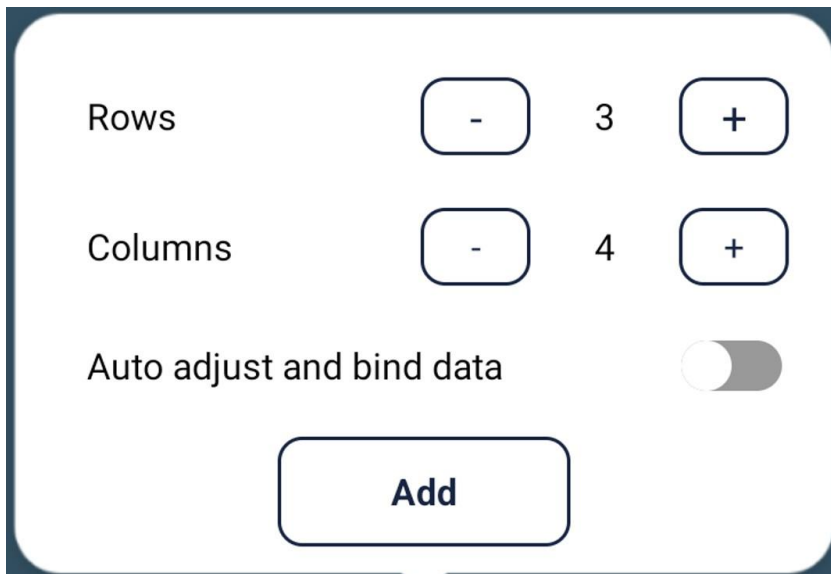



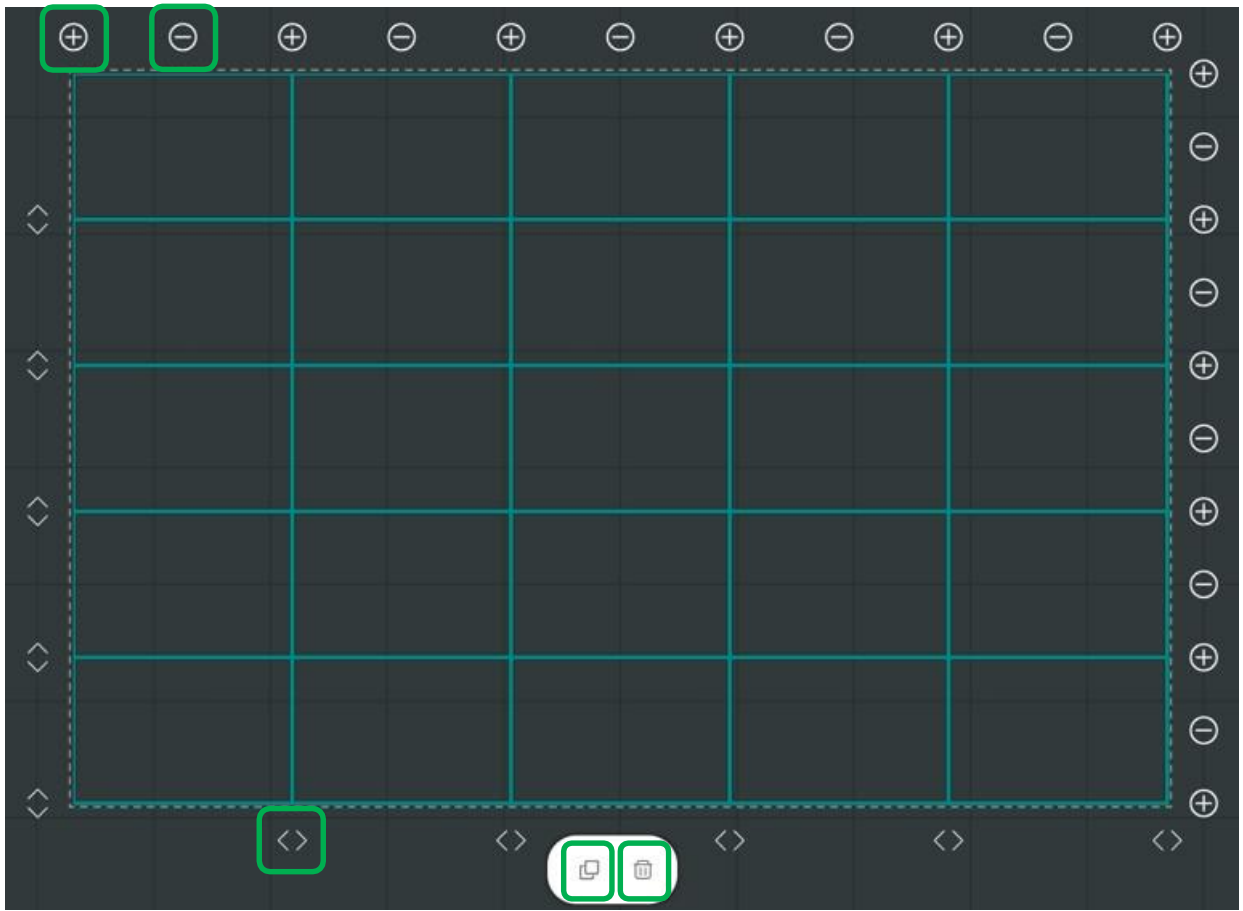

① Tools – Form

- Create a table.
- The table creation range is 1 to 10, and the default value is row: 3, column: 4.
- Automatic data adjustment and binding: When writing, any writing that falls outside the created table is automatically recognized and organized into the table.



- You can modify the table.

	Copy	* Copy the generated table.
	Delete	* Delete the generated table.
	Delete a cell	* Reduce the number of columns in the generated table.
	Add a column	* Increase the number of columns in the generated table.
	Resize	* Resize the columns in the generated table.

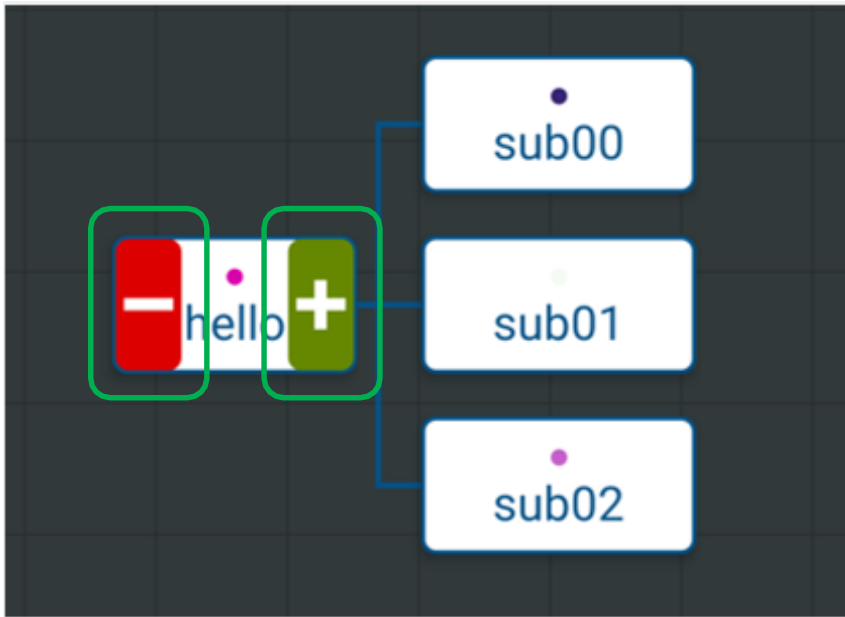

② Tools - Mind

- Create a mind map.
- The default is Main 1, Sub 3.
- You can change the contents of a map by tapping on it.
- Press +,- to increase or decrease the number of maps.
- You can change the placement of the map by pressing the center circle.

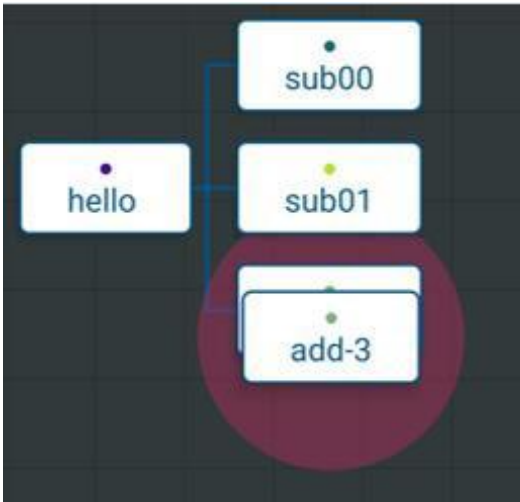

- You can change the placement of a map by dragging it to overlap it with another map.

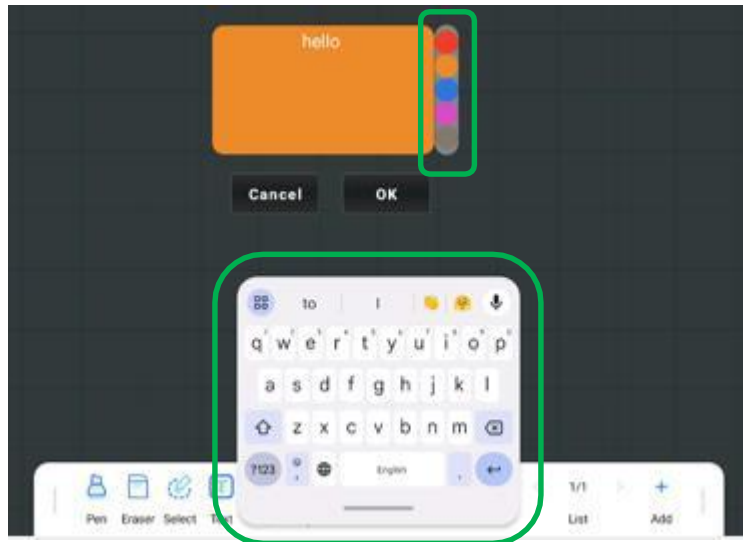

③ Tools - Current page note

- You can take notes for reference in the whiteboard.
- The keyboard at the bottom of the note allows you to write the contents of the note.
- You can specify the background color of a note by selecting the note's side-specified color.
- This note applies only to the current page and disappears when you switch pages.

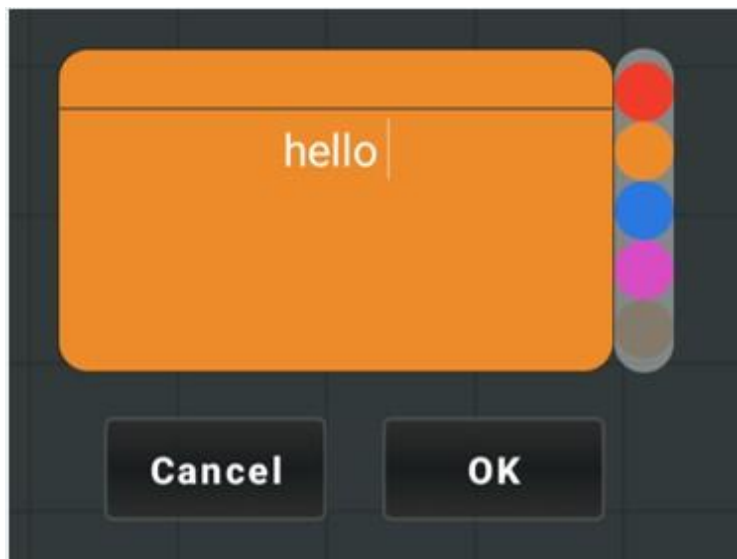

④ Tools - All page note

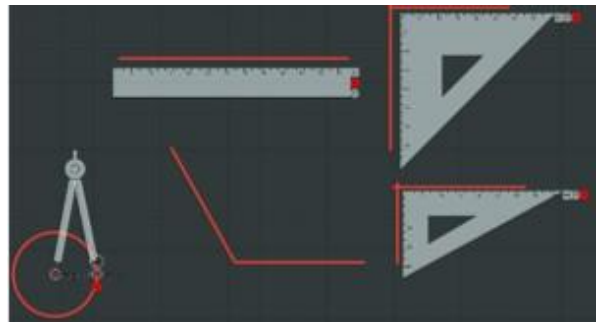
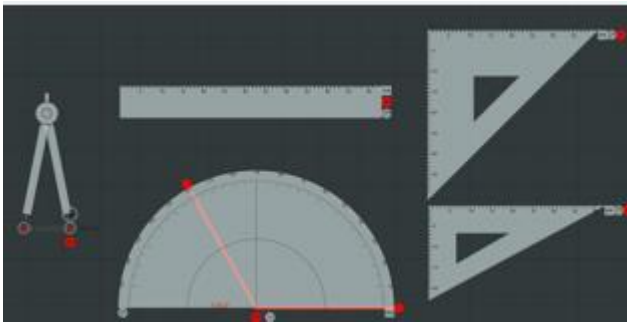
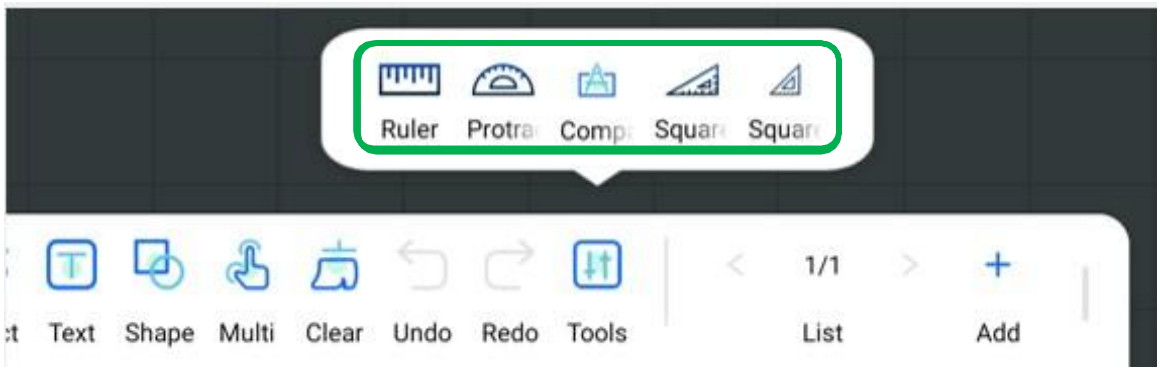

- You can take notes for reference within the whiteboard.
- The keyboard at the bottom of the note allows you to write the contents of the note.
- You can specify the background color of a note by selecting the note's side-specified color.
- This note applies to the entire page and remains in place when you switch pages.

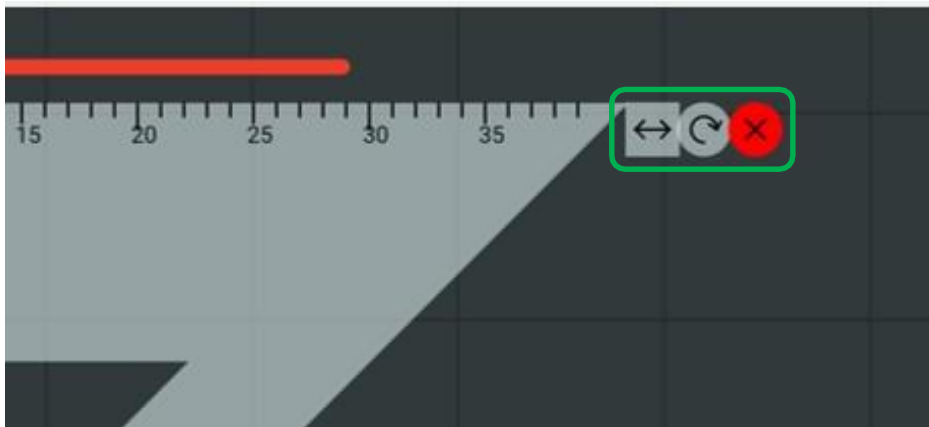

⑤ Tools - Puzzle bag

- You can use any math tool of your choice.





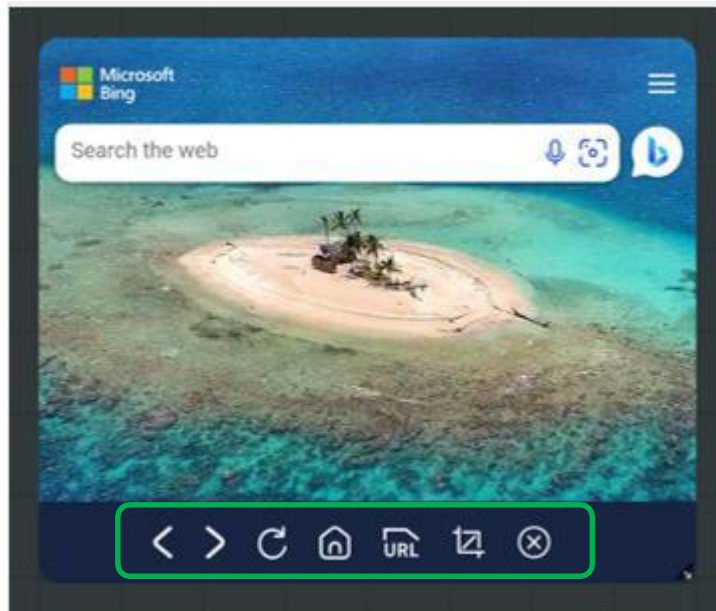



- Resize:  Tap to resize the tool.
- Rotate:  Press to rotate the tool for use.
- Delete:  You can delete the tool.



⑥ Tools - Web browser, picture, video

- You can use the web browser search function in the whiteboard.
- In the whiteboard, you can use Web pictures to enable photo-related searches.
- You can use Web video in the whiteboard to search for videos.

	Back	* Retrieves the previous page.
	Go forward	* Brings up the following page.
	Refresh	* Reloads the current page to show the latest content.
	Home	* Brings up the home screen.
	URL search	* Brings up the URL search bar.
	Screen Capture	* Captures the browser screen and pops it up.
	Exit	* Exit the web browser window.

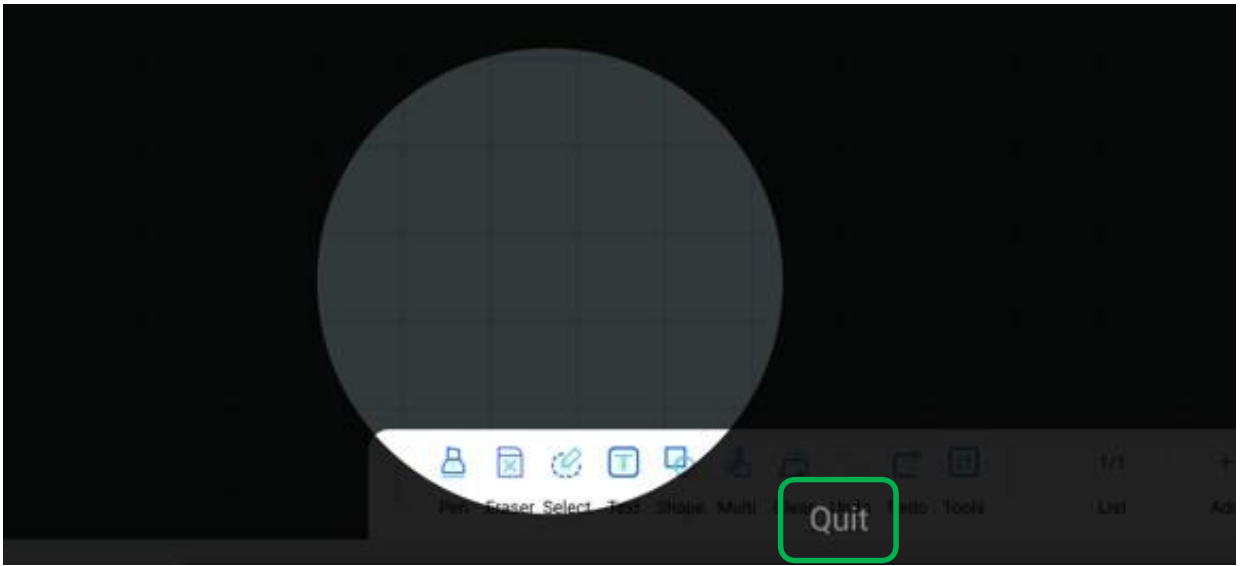

⑦ Tools - Spotlight

- Touch and drag the screen to specify the Spotlight area.
- Press Quit to exit the function.

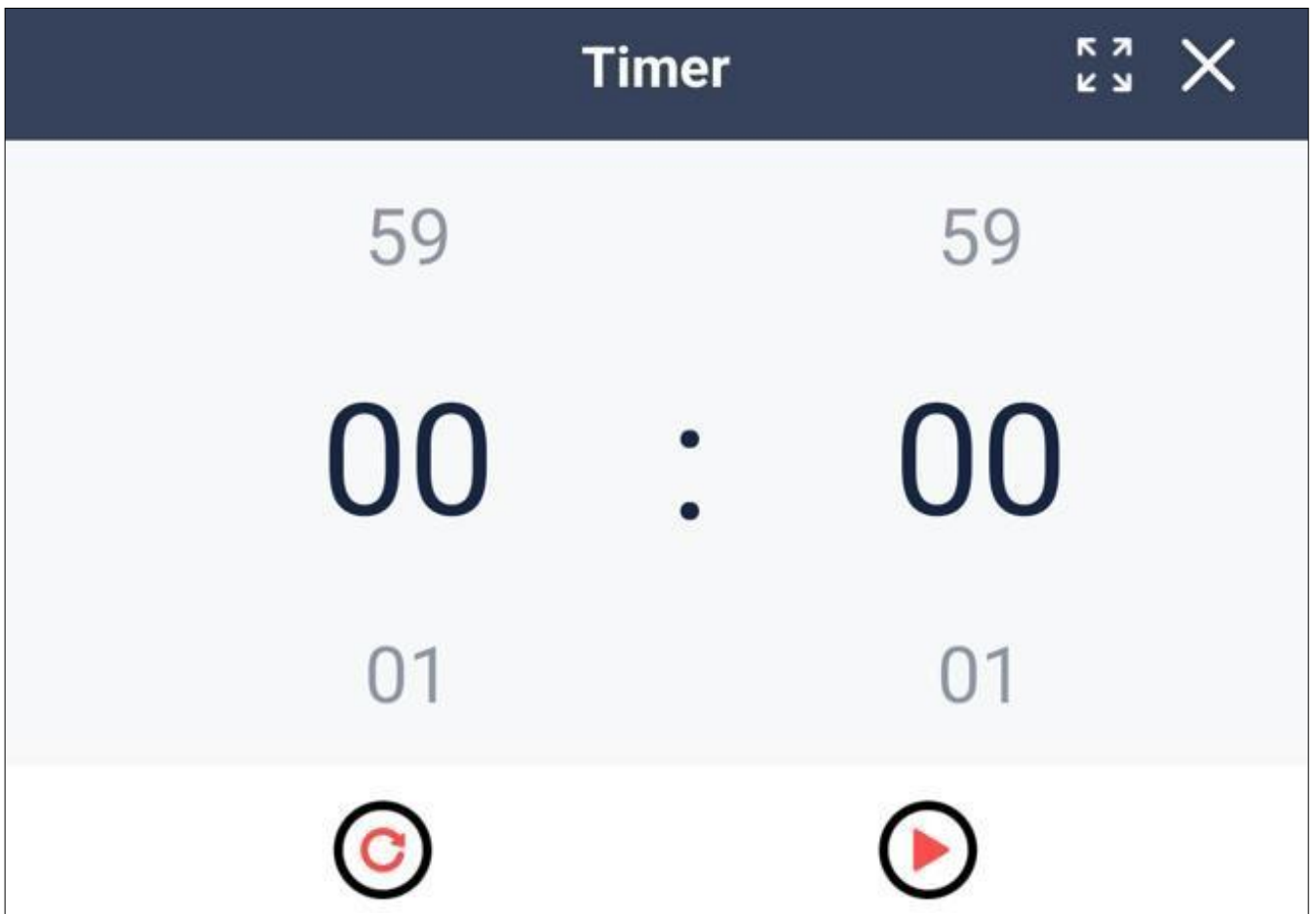

⑧ Tools - Timer

- You can use the stopwatch feature.

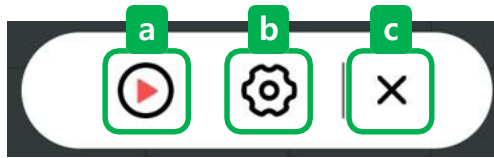

9 Tools - Record screen

- You can record the screen of the whiteboard.
- a. Press the Play button to start recording.

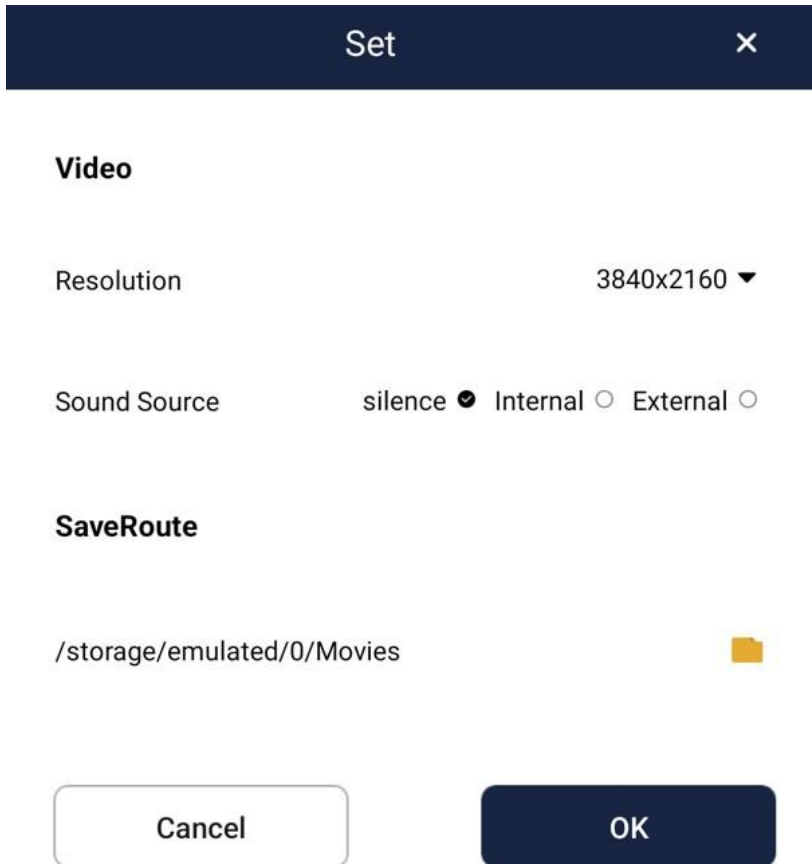

- b. Change the video settings.
Resolution: Change the resolution.
Sound source: Change the sound source. Save route: Change the video's save path.
- c. Exit the video recording feature.



⑩ Tools - Split screen

- Screens can be split, and the number of splits can range from 2 to 4.



A. Split Screen Individual Features

- _ The Pen, Eraser, and Clear functions are available for each split screen.
- _ Each feature is unmodifiable, unlike the features on the existing screen.



b. Full Screen Features

- _ Exit split: Exits the split screen and returns to the original screen.
- _ Number of Splits: You can adjust the number of splits by selecting from 2 to 4.
- _ Clear: Clears the contents of all split screens.

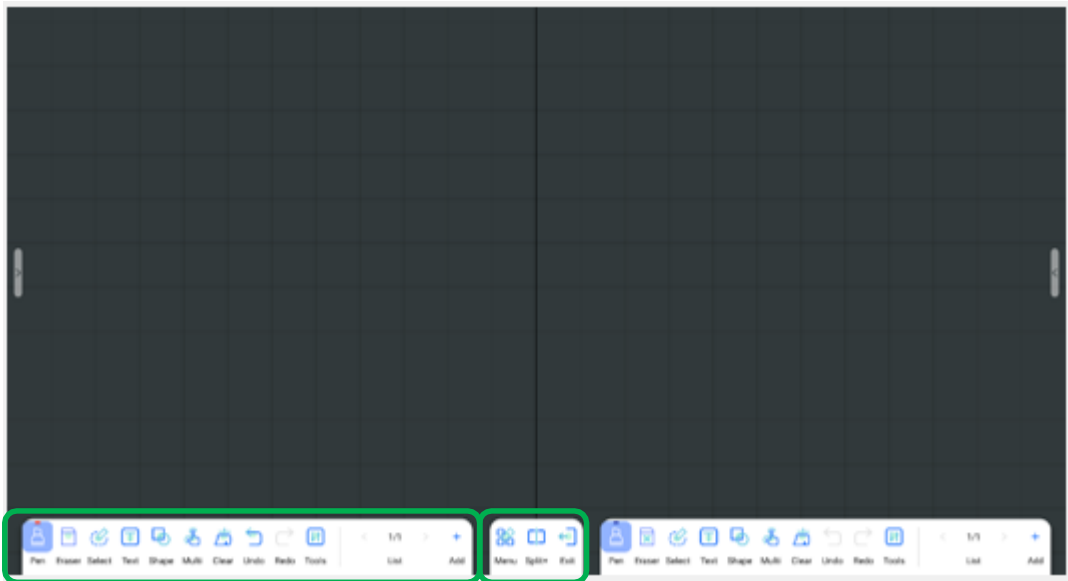

11 Tools - Split+

- Unlike a traditional split screen, you can still use all the features of the main screen after a split screen.

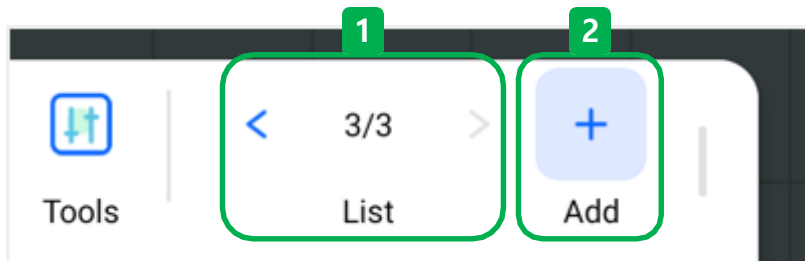

6.2.11 Page management

- You can manage whiteboard pages.

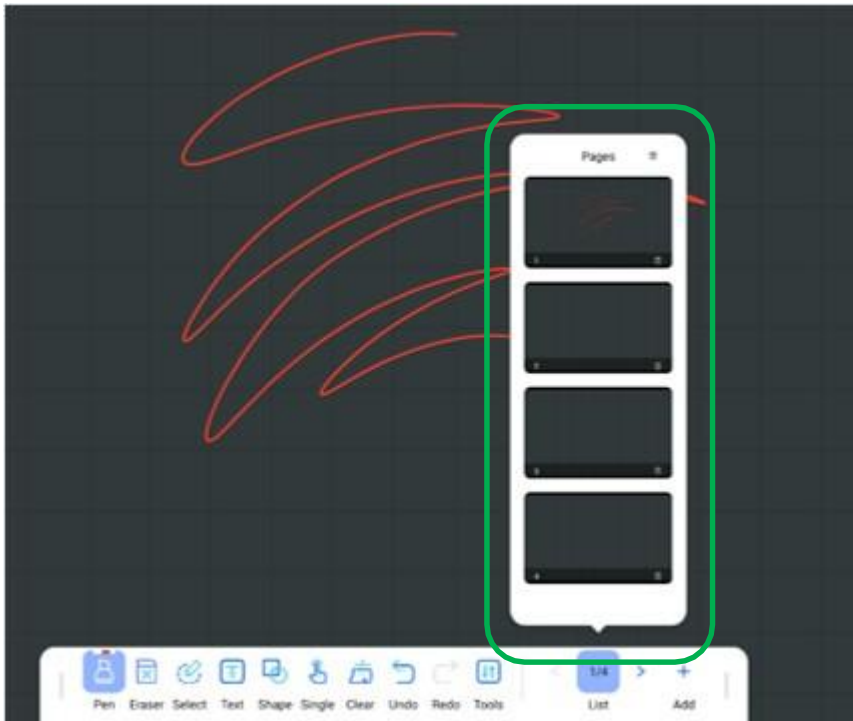

Switching pages

- < Flip to the previous page.
- > Turn to the next page.
- After pressing 'List', you can tap any page in the list of pages to bring it up directly.

Add a Page

- Add the number of available pages.
- The default page count is 1/1 page.

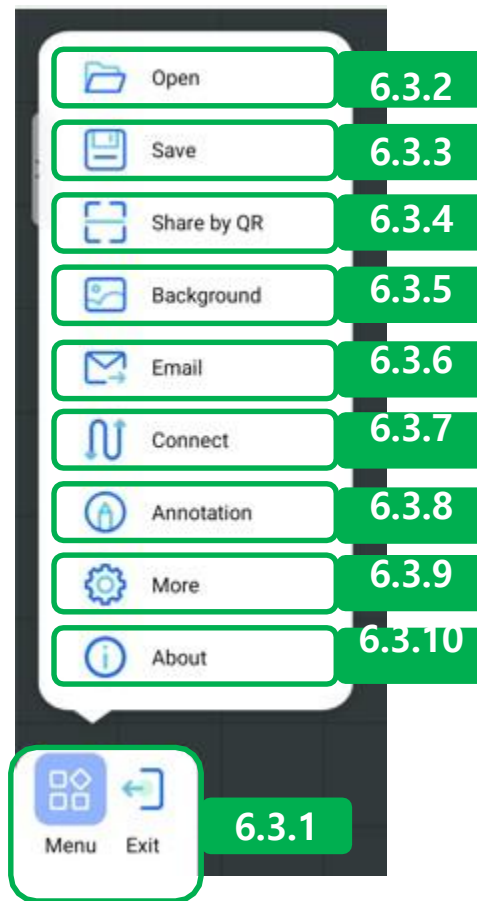

6.3 Side menu

6.3.1 Menu & exit

Menu: Open the Menu window to select and use the desired function.

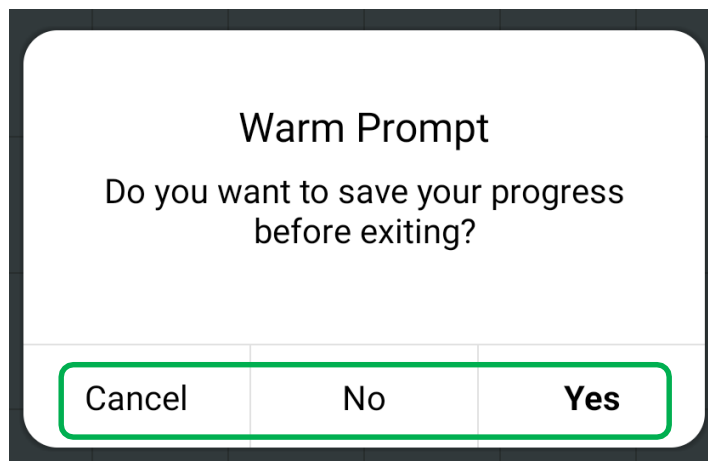

Exit : Exit the White board app.

- Cancel: Cancel closing the whiteboard app.
- No: Exit the app without saving the contents of the whiteboard.
- Yes : Save the contents of the whiteboard and exit the app.

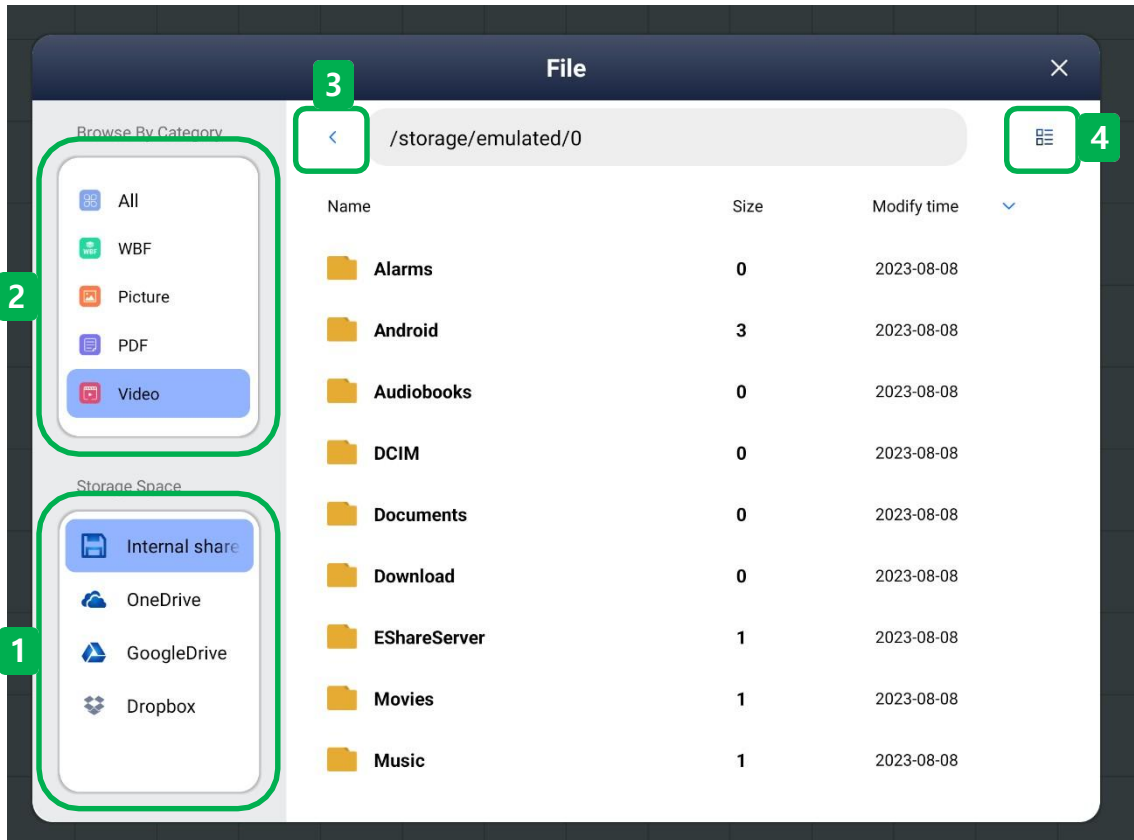

6.3.2 Open

- ① File storage list: You can select an available storage to use.
- ② Categorize file extensions: Show only the selected extensions.
- ③ Back: Flip the page to the previous page.
- ④ Format conversion: Convert the way the files are listed.

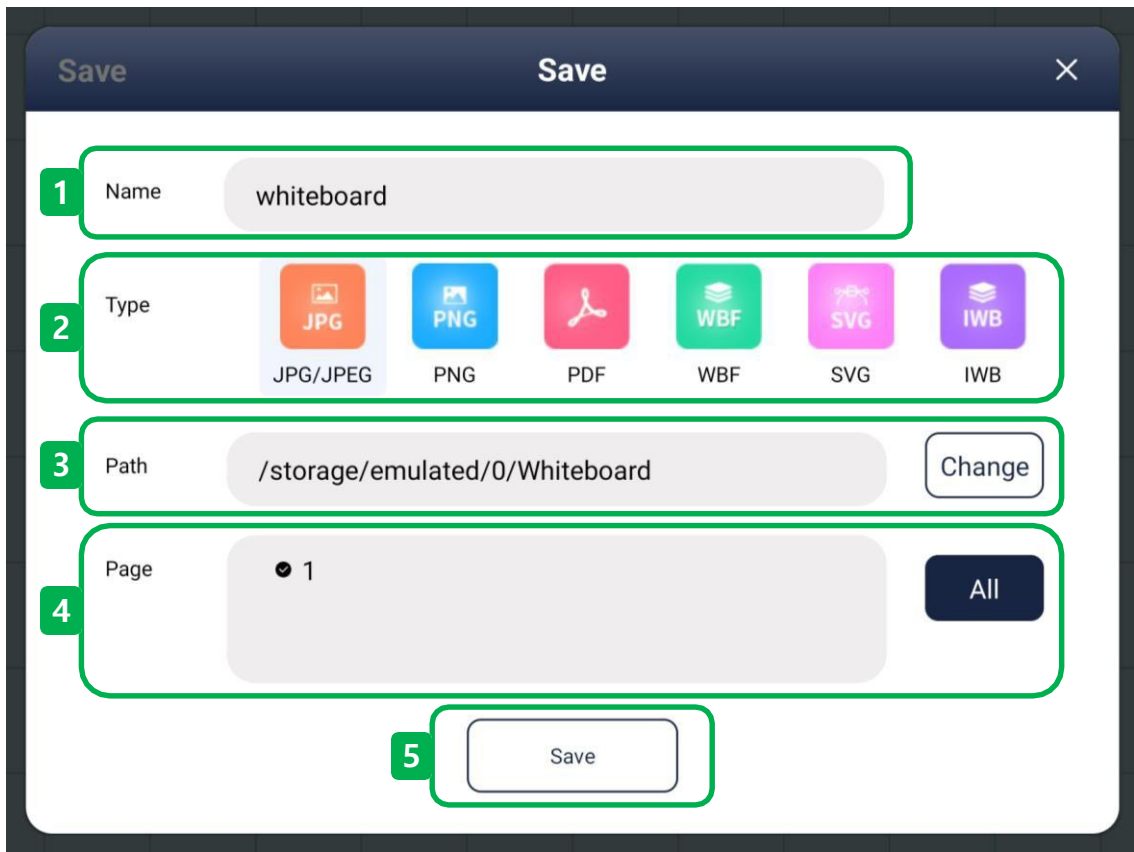

6.3.3 Save

- ① Name: Display the file name.
- ② Type: Select the extension of your save file.
- ③ Path: Select a storage location for the save file.
- ④ Page : Select a page of the whiteboard to save.
- ⑤ Save : Click the Save button to save the file.

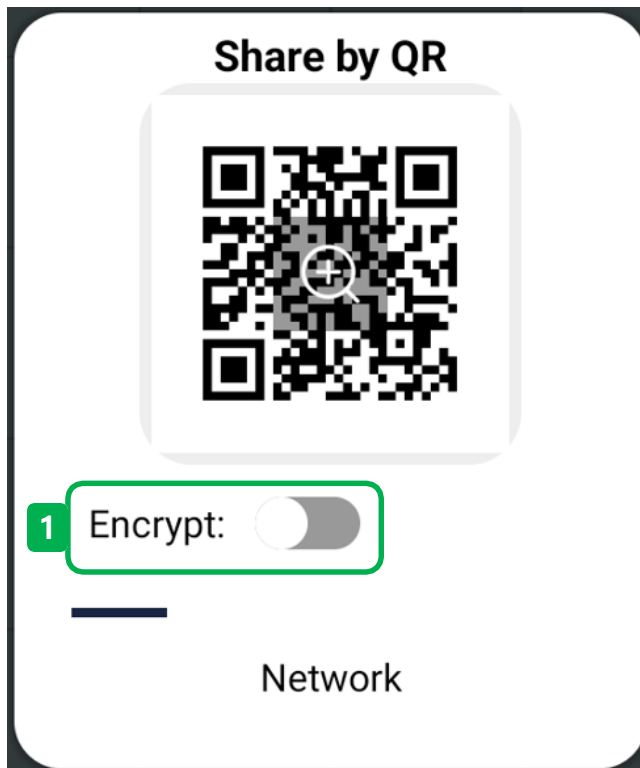

6.3.4 Share by QR

- Share data by scanning a QR code. This feature works when devices are connected to the same network and use the to work.

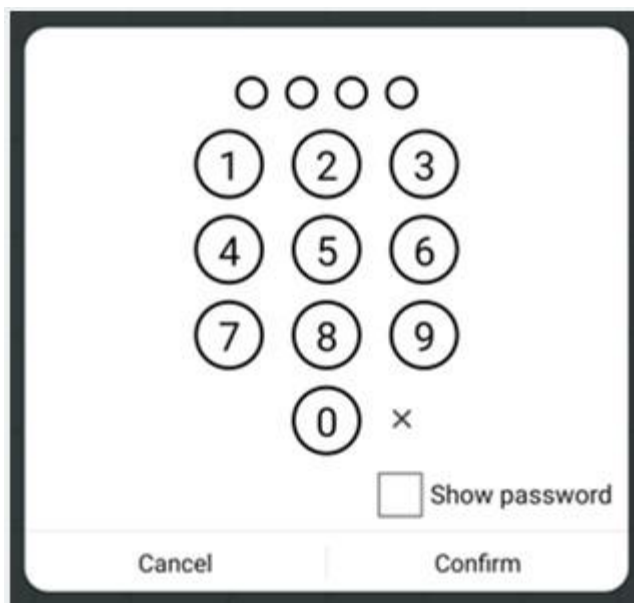

① Encrypt: Enter a total of 4 digits to assign a password to the QR code.

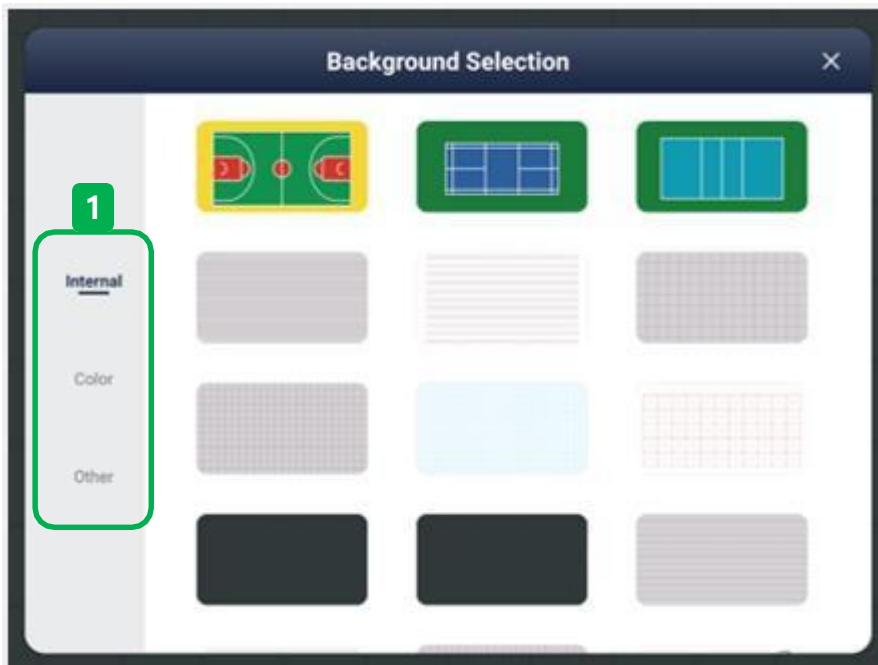

6.3.5 Background

① Internal: You can change the background by selecting from 15 default backgrounds.



② Color: You can change the solid color background by freely selecting it from the Color board.

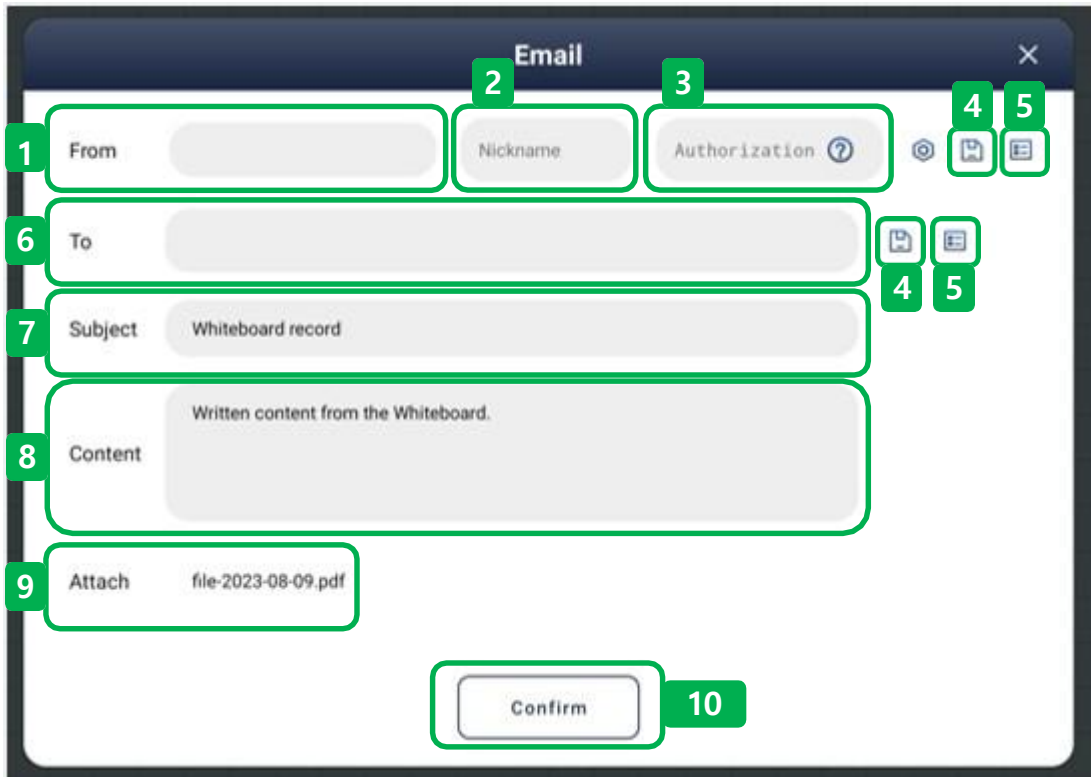

6.3.6 Email

- ① Sender - email address
- ② Sender - Name
- ③ Sender - Password
- ④ Save sender/recipient's account information
- ⑤ Select the sender/recipient's account
- ⑥ Recipient - email address
- ⑦ Edit the email subject
- ⑧ Edit email content
- ⑨ Send Date
- ⑩ Send an email

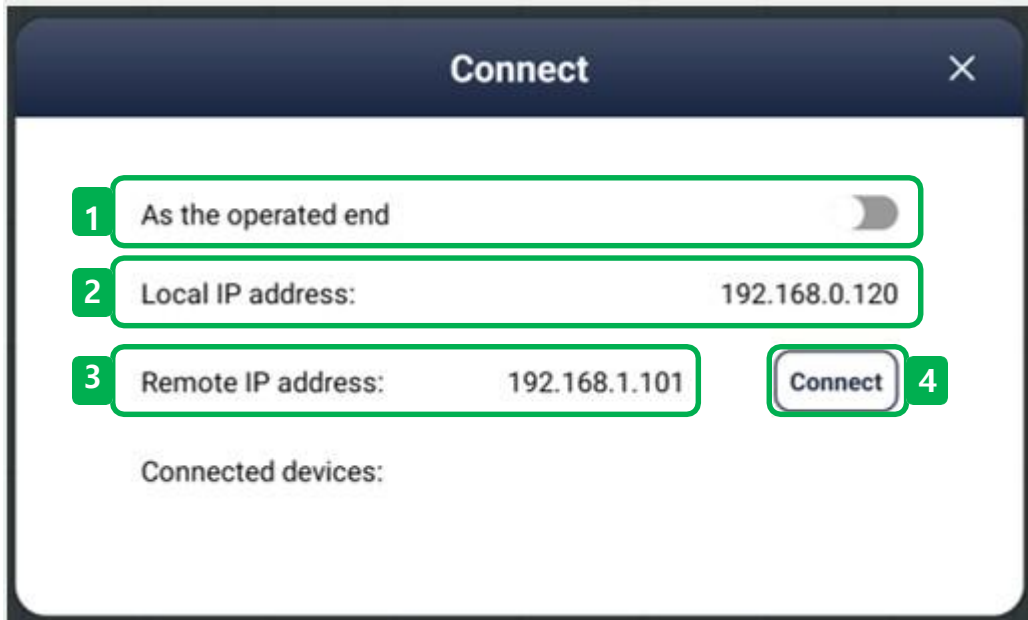

6.3.7 Connect

- ① As the operated end : Configure both whiteboards to the same network environment to share the whiteboard's screen.
- ② Local IP address: Indicates the network IP address of the current product.
- ③ Remote IP address: Indicates the network address of the blackboard to be connected.
- ④ Connect: Connect the two boards.

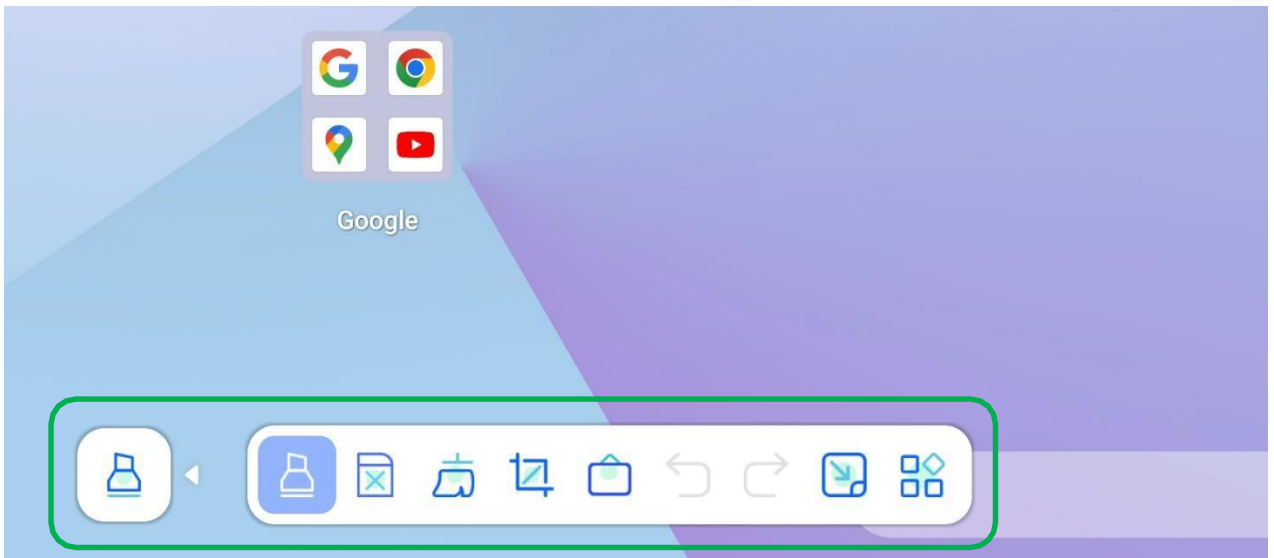

6.3.8 Annotation

- Users can hide or expand the Toolbar by pressing the left main icon.
- Users can change the position of the icon by dragging the left main icon.

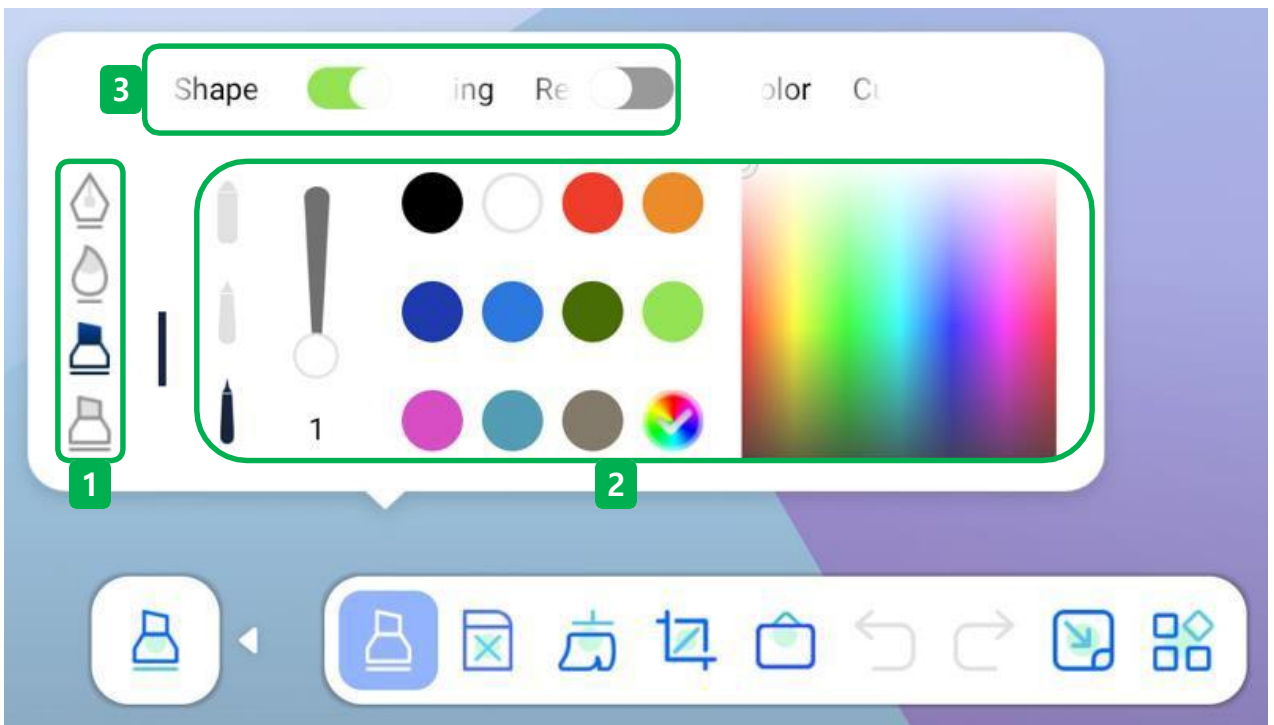

6.3.8.1 Pen-Annotation

- Users can freely change the type, thickness, color, etc. of the pen.

① Pen type

- There are three types of pens: fountain pens, brush pens, and marker pens.

① Pen type

- There are three types of pens: fountain pens, brush pens, and marker pens.

② Pen's set by thickness recognition

- A total of 3 types of Pens can be used at the same time for each touch recognition thickness.
- S(Small Finger) : 2.8mm, B(Big finger) : 6.5mm, F(Stylish big finger) : 10mm
- Users can adjust the boldness by Pen's recognition, and can adjust it from 1 to 30.
- Users can freely specify the color on the color board according to Pen's perception.

③ Recognition function

- Automatically recognize the shape of the handwriting written in Pen and convert it into shapes or text. (Choose one of the two and use it: Shape regeneration or Text regeneration..)

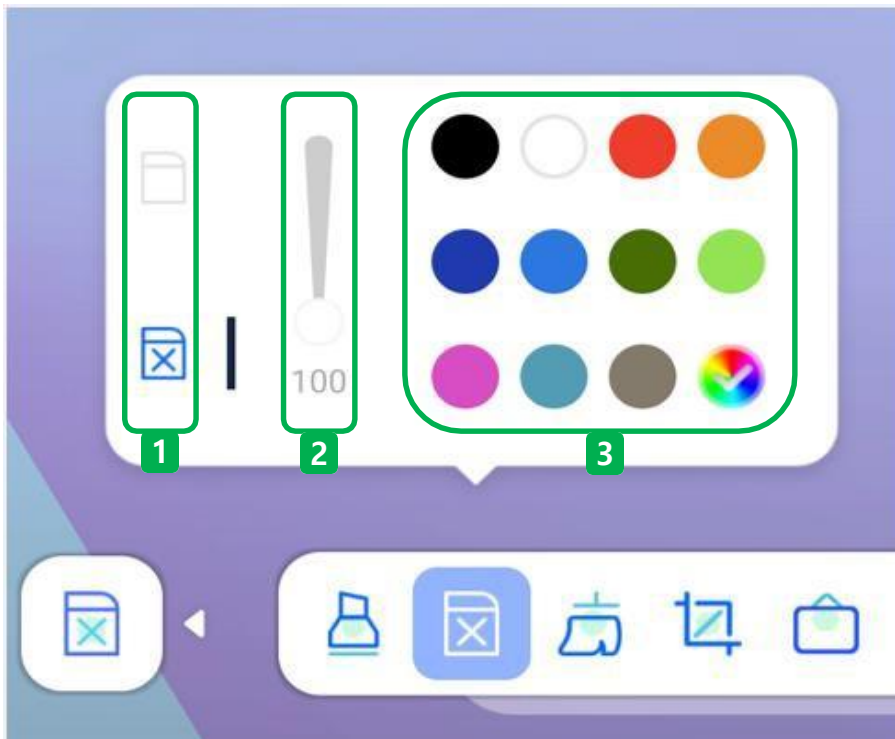

6.3.8.2 Eraser-Annotation

- Users can freely change the type, size, and color of the eraser.

① Eraser type



<Default>



<select>



<gesture>

- There are three types of Eraser: basic, select and gesture.
- Basic: It is an eraser with adjustable size, and you can freely specify and use it from 100~350.

② Resize the eraser

- It can be used by adjusting the size of the eraser, from 100 to 350.
(This function works only in the default eraser..)

③ Select an eraser color

- Specifies the color of the object that users want to erase so that the eraser function works only for the specified color.
- This color allows the eraser function to work in all colors.
(This feature works only in the selection eraser..)

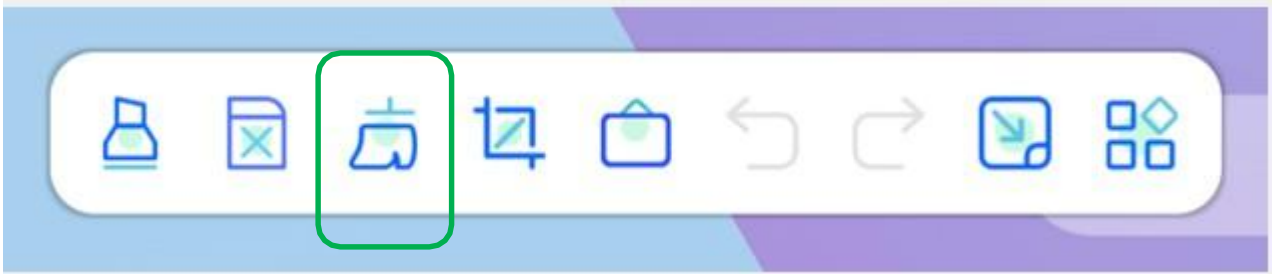

6.3.8.3 Clear-Annotation

- Erases all content on the screen at once.

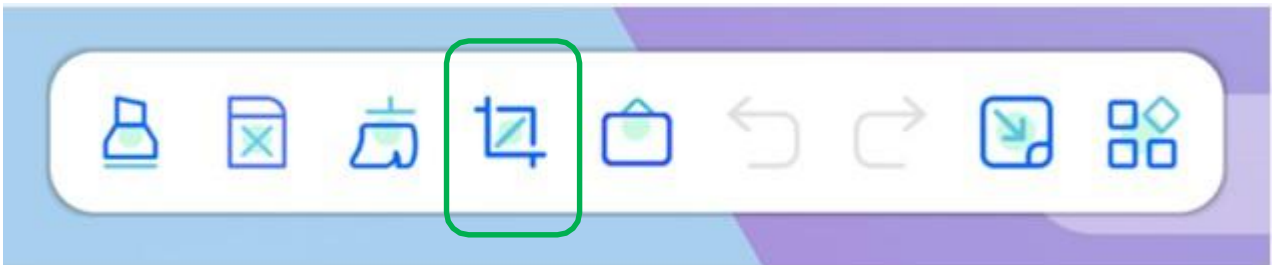

6.3.8.4 Screen shot-Annotation

- Capture the current screen.

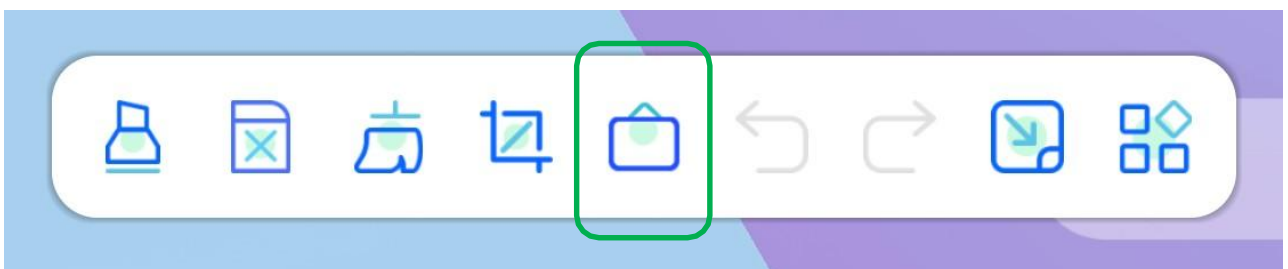

6.3.8.5 White board connection-Annotation

- Immediately launch the White Board window.



6.3.8.6 Undo & Redo-Annotation

- Undo : Cancel the most recent touch.
- Redo : Recover the most recent touch..



① Save-Annotation

- Name : Displays the file name.
- Type : Select the extension for the save file.
- Path : Select the storage for the save file.
- Page : Select the content of the Annotation to save.
- Save : Press the Save button to save the file.

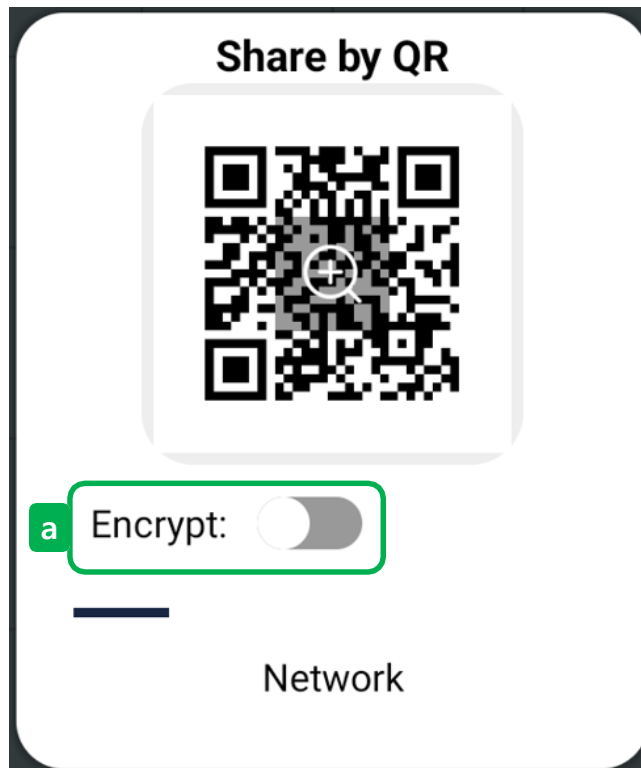

② Share-Annotation

- Scan the QR code to share data. This function must be connected to the same network between devices.

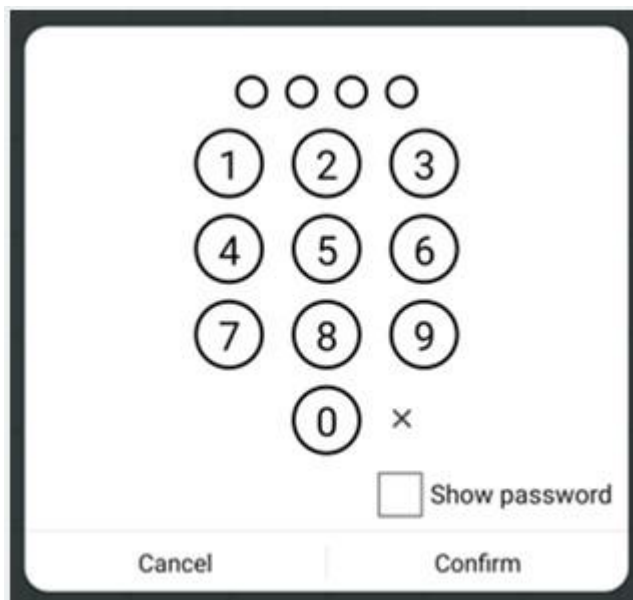

a. Encrypt : Enter a total of 4 digits to give a password to the QR code.

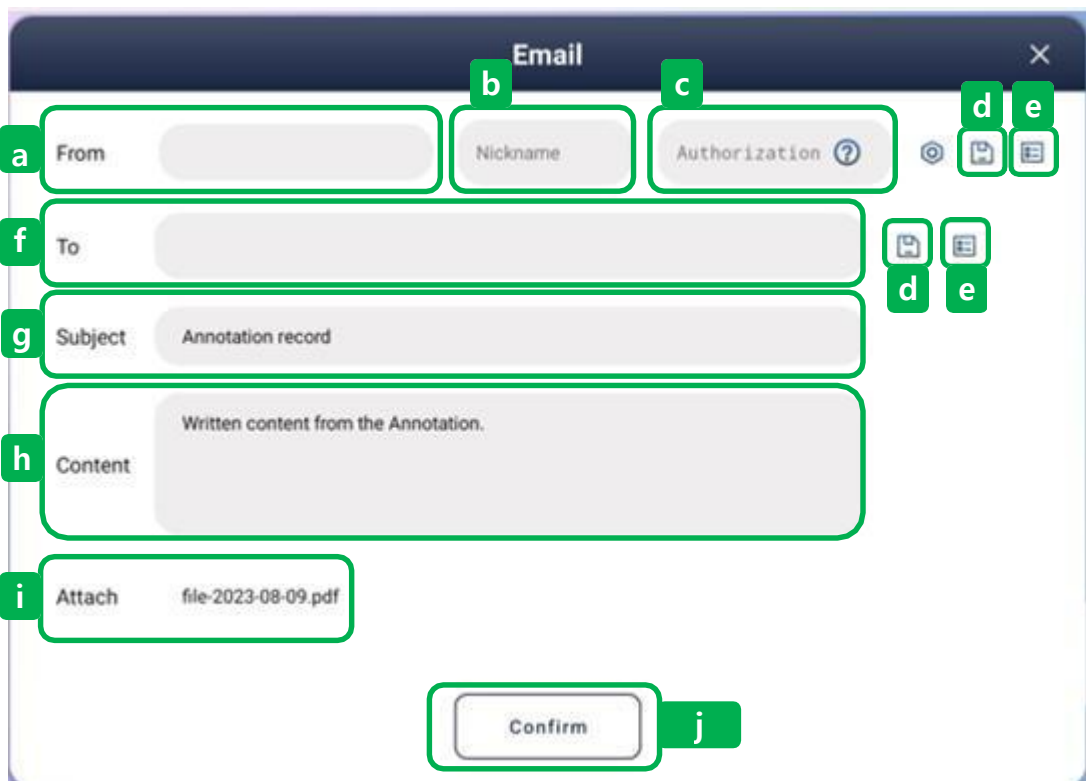

③ Email-Annotation

- a. Sender -Email Address
- b. Sender - Name
- c. Sender -Password
- d. Save account information of sender/recipient
- e. Select account of the sender/recipient
- f. Recipient -Email Address
- g. Email title modification
- a. il content modification
- l. Sent date
- J. Send a email.



a

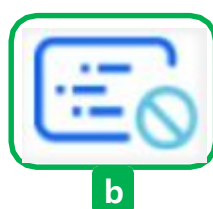

b

④ Background stop-Annotation

- a. Status: Background Screen changes to dynamic state when clicking on the button.
- b. ic status: Background screen is changed to static state when clicking on the button.

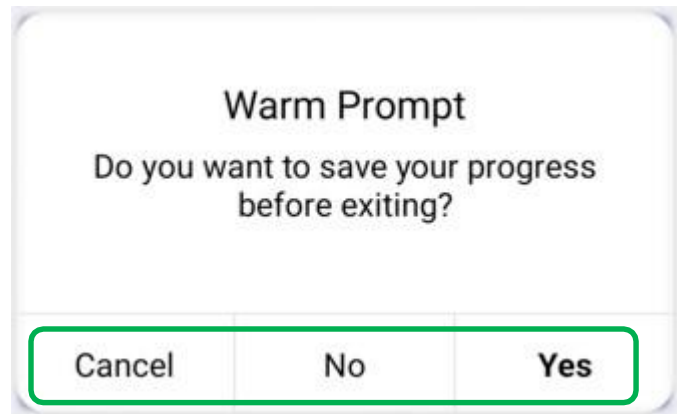
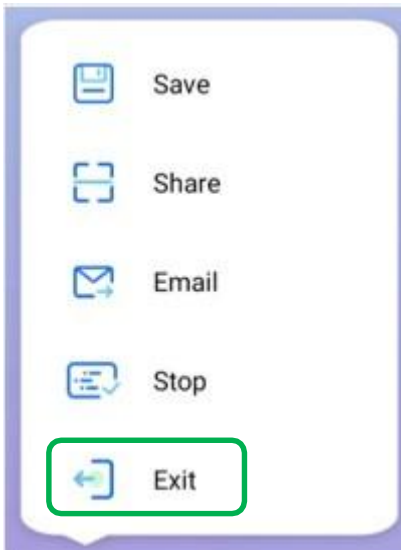

⑤ **Exit-Annotation**

- cel : Cancel the exit of the White board app.
- : Exit the app without saving the content of the White Board.
- es : Exit the app with saving the content of the White Board.

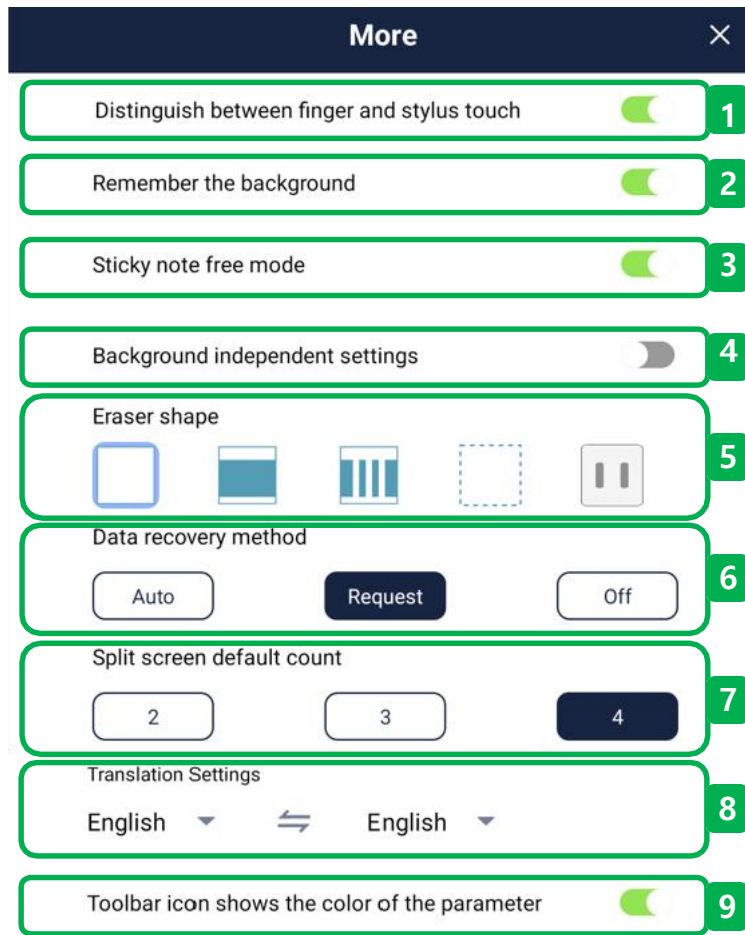

6.3.9 More function

- ① On/off the pen type function according to the pen thickness recognition.
- ② On/off the function to keep the wallpaper the same as before the shutdown when running the Whiteboard app again after exiting.
- ③ On/off the function that allows the entire page notes to move freely.
- ④ On/off the function that allows to set the wallpaper differently for each page.
- ⑤ Change the appearance of Eraser.
- ⑥ On/off the function to recover the contents of the Whiteboard app when it is forced to shut down.
- ⑦ Specifies the default number of split screens when using the Split screen feature.
- ⑧ Set the first translation language when using the Text translation feature.
- ⑨ On/off the function that shows the current color status of the toolbar icon.

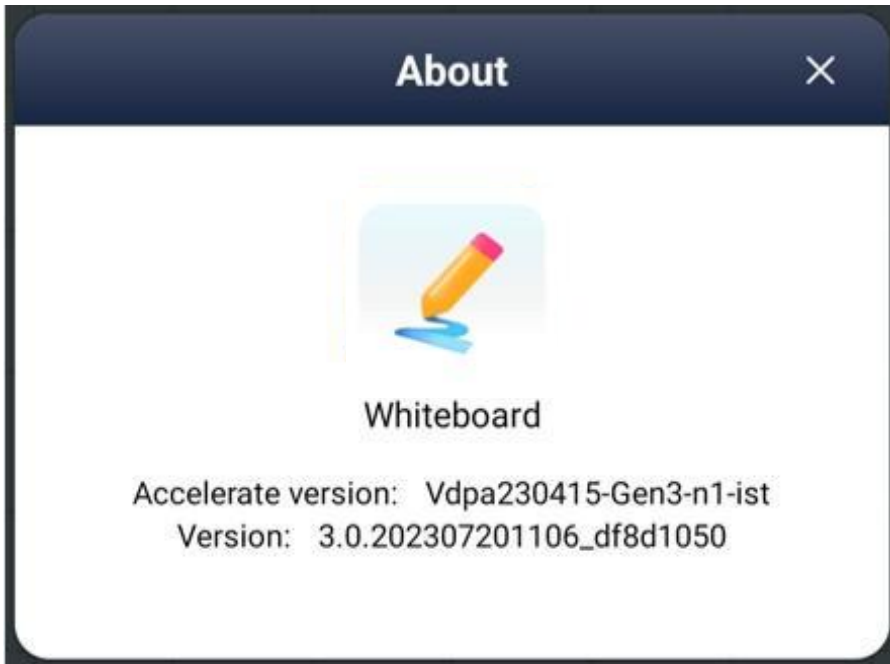

6.3.10 About

- Check the latest version information of the Whiteboard App.

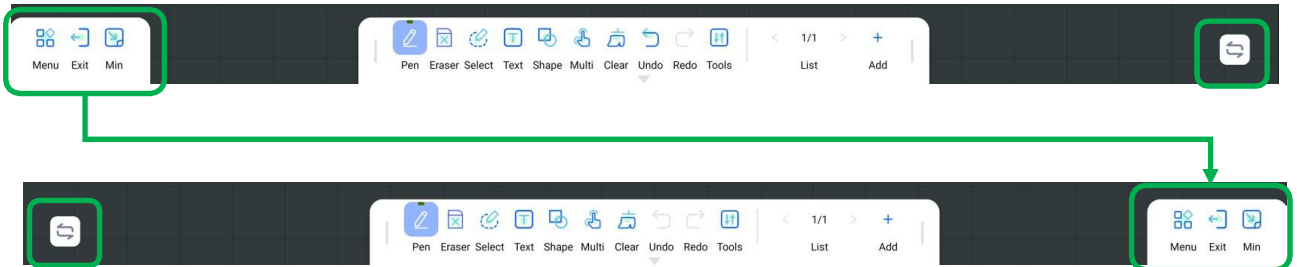

6.4 Side menu bar swap

- Change the location of Side Menu Bar by pressing the SWAP button.

7. Side toolbar

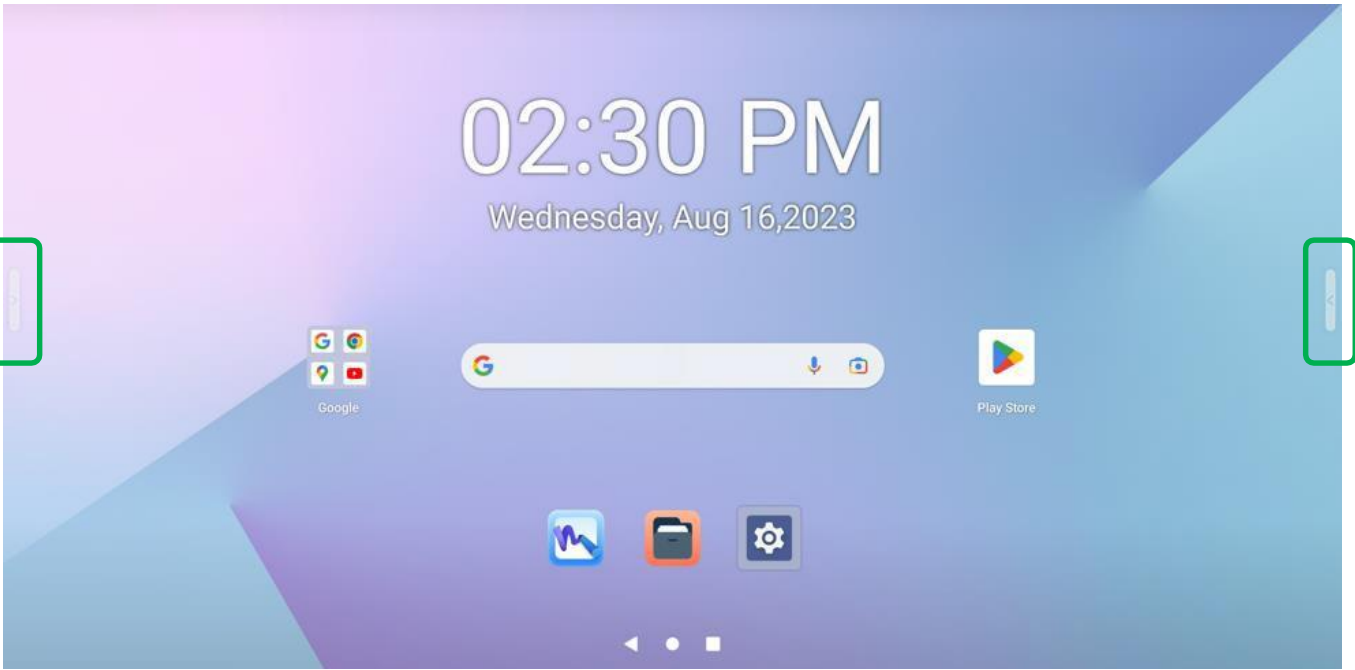

❖ Side toolbar

- By using the function of the side toolbar, users can use the device more easily and quickly.

7.1 Shortcuts

Home Back Apps Source

Source Prev Annotation Float Ball Multi Display

7.2 Recent Tasks

Settings Netflix Firefox File Manager

7.3

7.1 Shortcuts

- By registering frequently used features within the device, users can quickly operate the functions.
- Up to 8 can be registered on the main screen, and can change the registration function by pressing the button.



7.1 Shortcuts

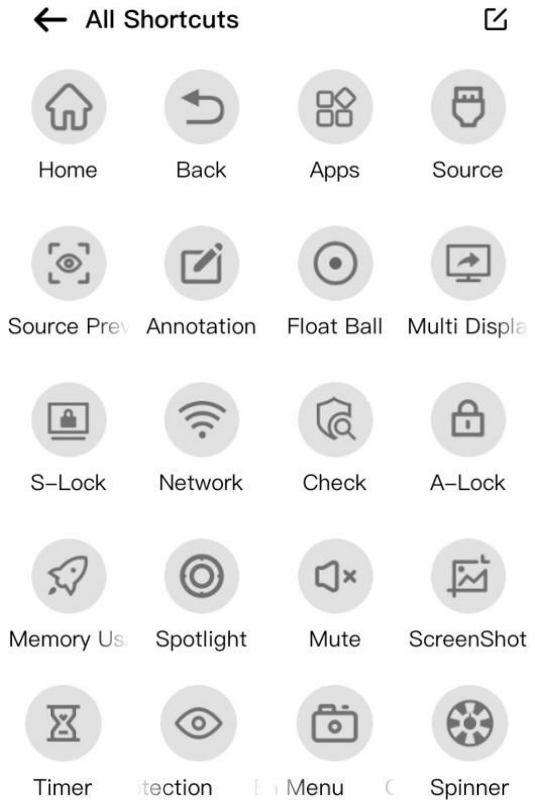



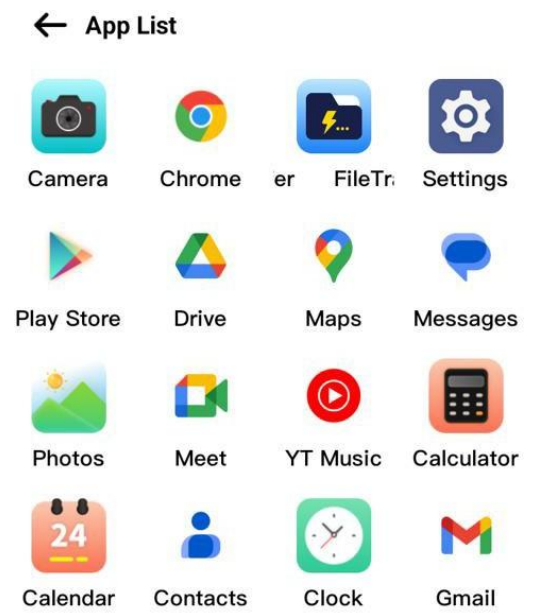

- ① Home : Go to the main home screen.
- ② Back : Go to the previous screen.

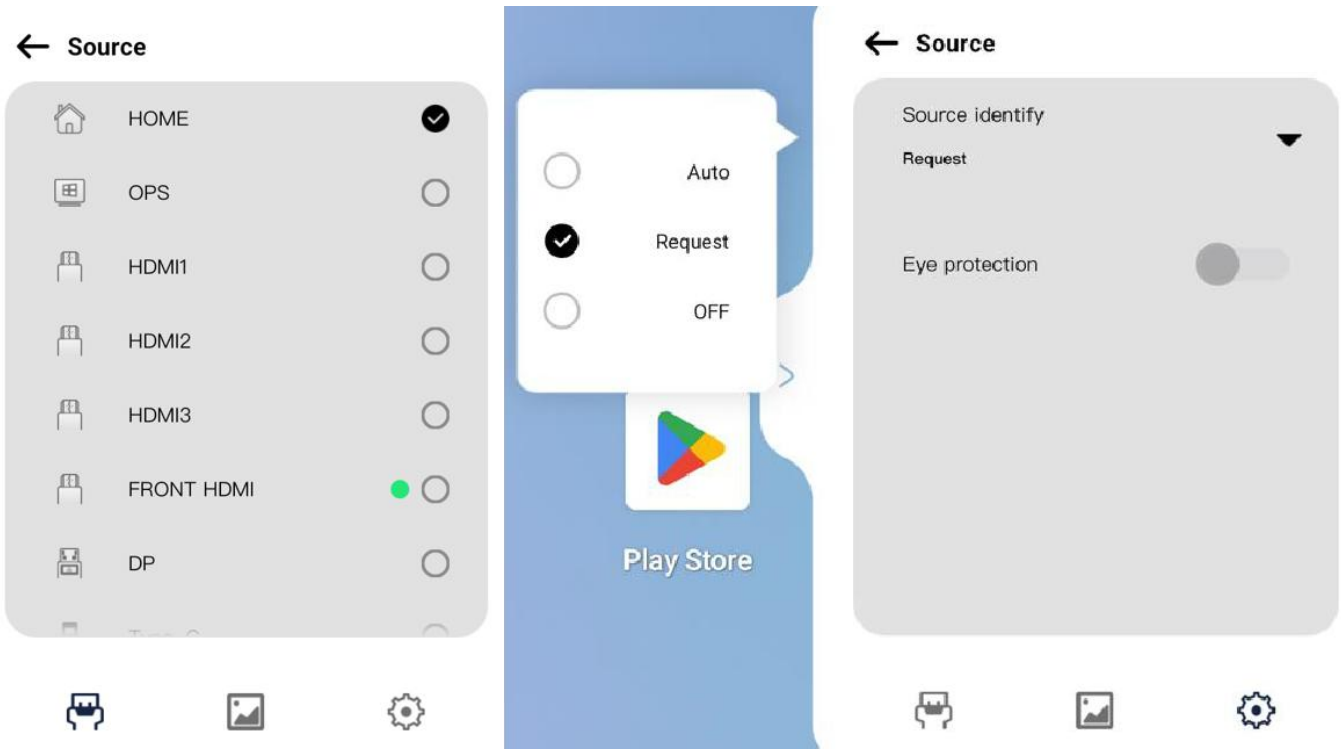

- ③ Apps : Shows the apps on the device.

7.1 Shortcuts



- ④  Source : Shows the source that the device is connected to or can be connected to
- Touch  icon to set the transition method upon source recognition, and to set eye protection.
- ⑤  Source preview : Users can view the connected screen first before switching the screen of the connected source.
- ⑥  Annotation : Regardless of the current screen status of the device, users can write on the screen.





- ⑦ Float ball : Even when the screen is switched, users can use the frequently used buttons separately.

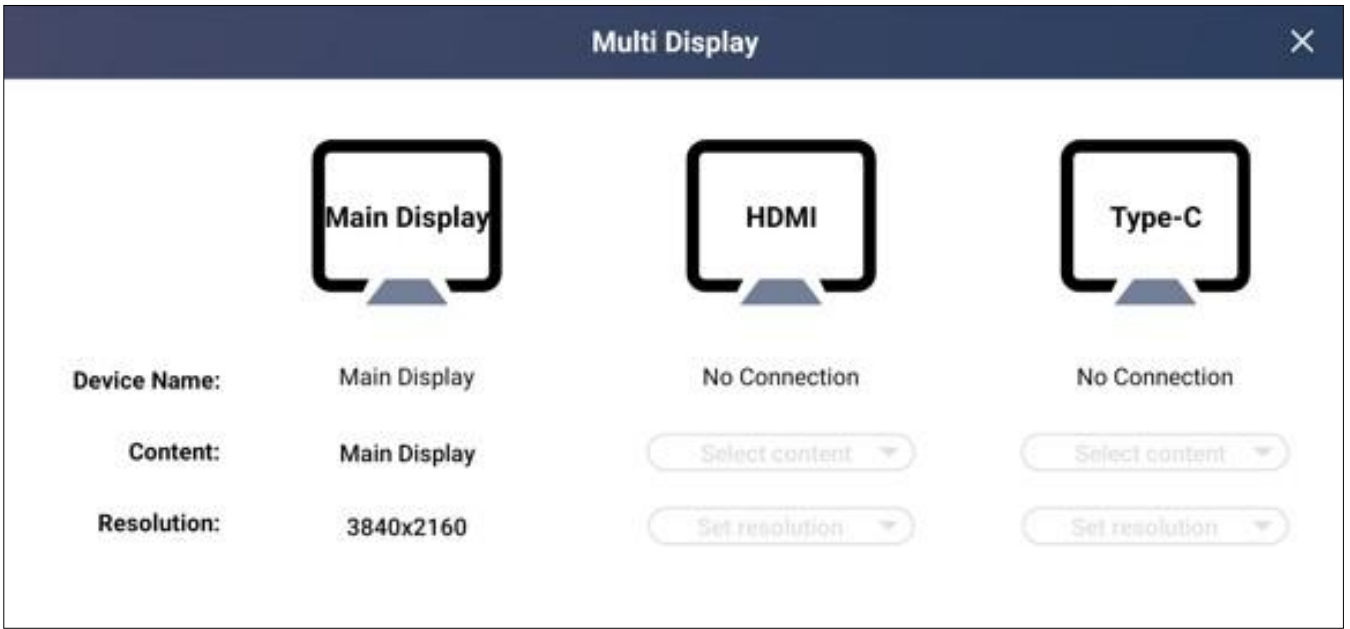

7.1 Shortcuts





- ⑧  Multi display : Check data such as the connection status and resolution of multiple display sources.
- ⑨  S-Lock : Lock the screen by assigning a password to the current screen.
- ⑩  Network : Check the connection status by opening a network window.



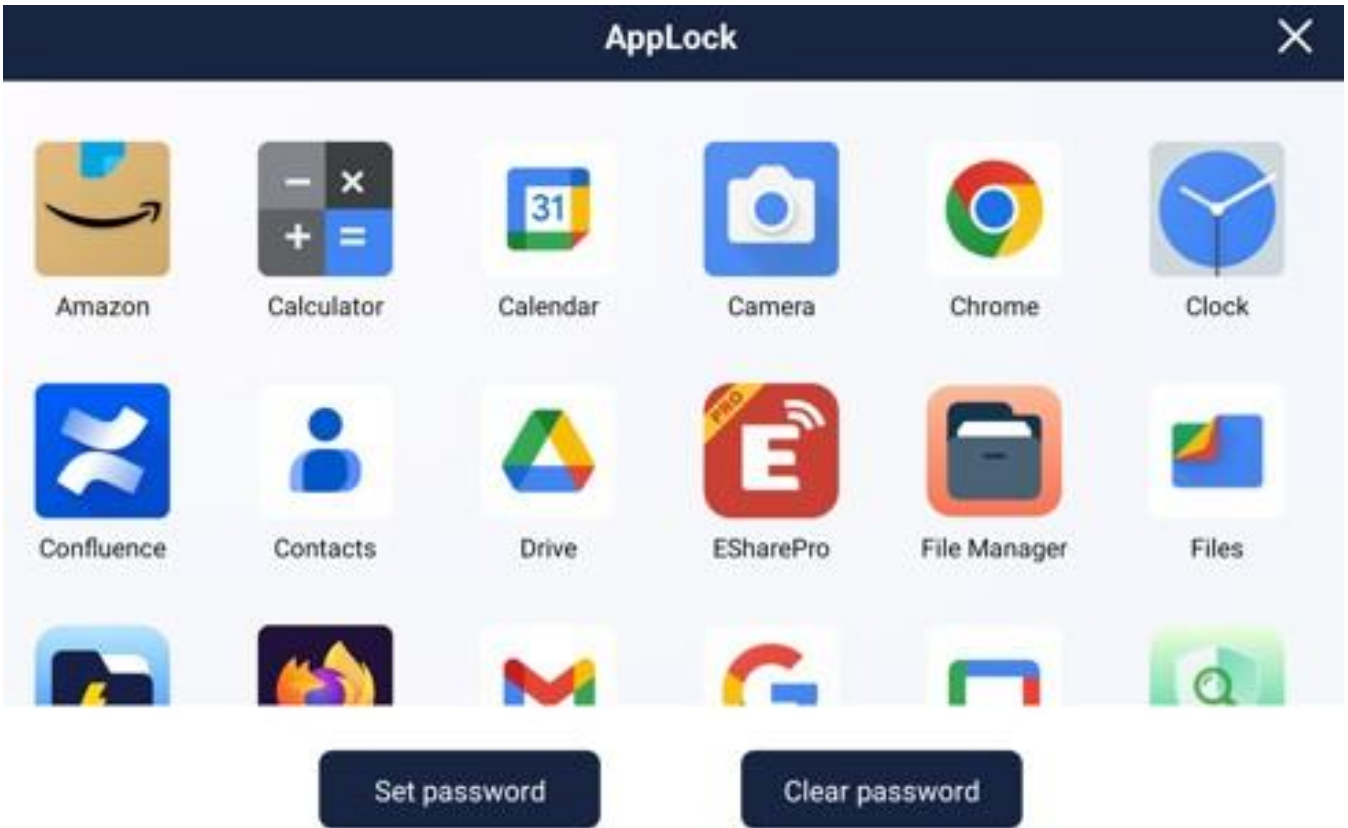

- ⑪  Check : Check the current hardware status in the current device.

7.1 Shortcuts



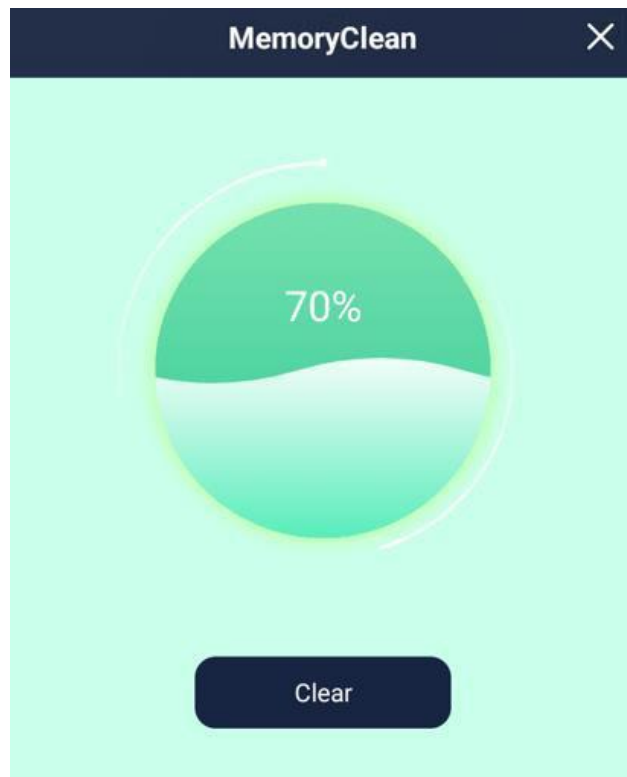

⑫  A-Lock : Lock by giving passwords to apps in the device.





⑬  Mem clear : Check the current memory status and delete unnecessary data.

7.1 Shortcuts

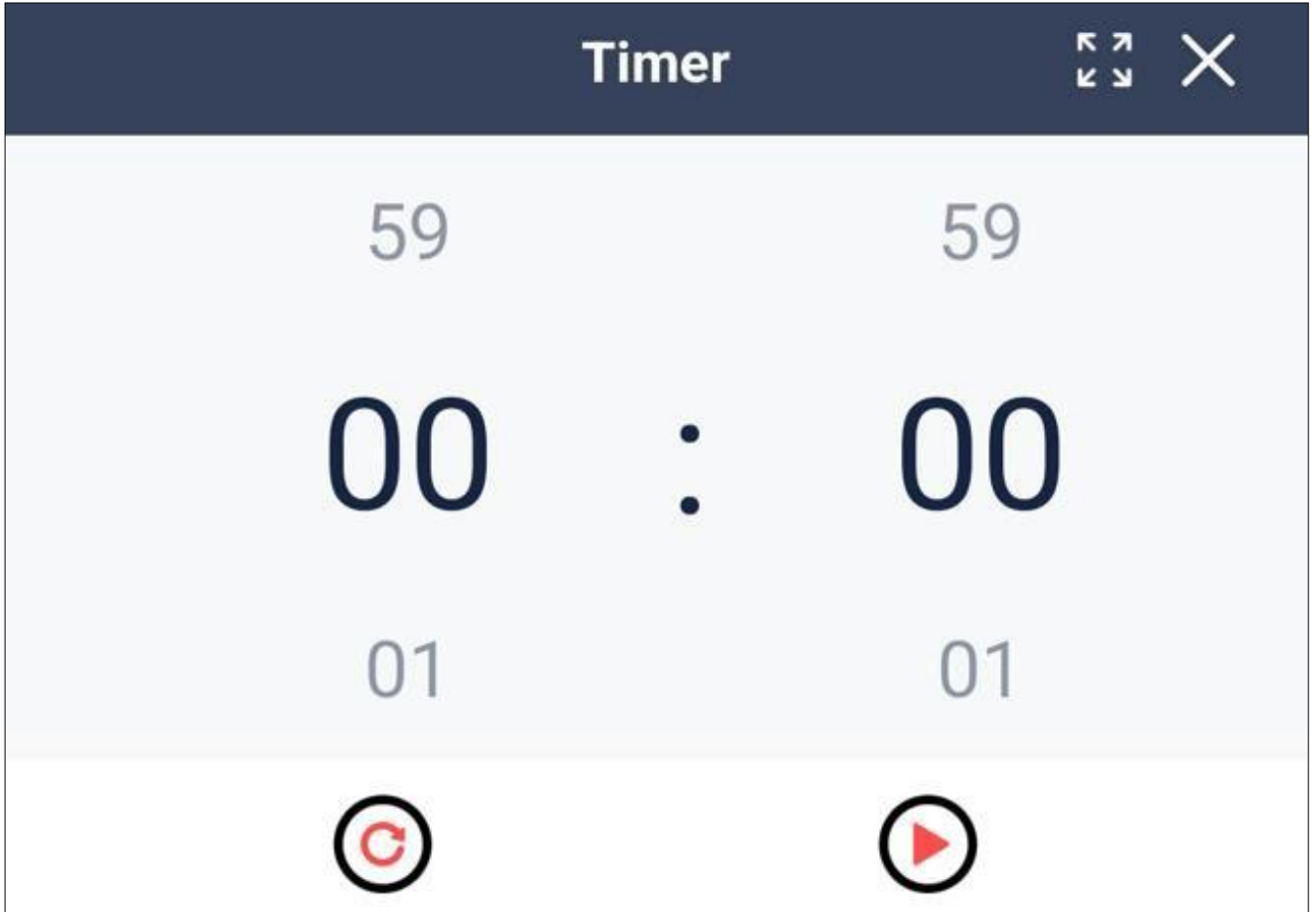
- ⑭  Spotlight : Darken the rest of the area except for the specified area.
- ⑮  Mute : Change the sound of the device to 0.
- ⑯  Screen shot : Capture the screen by specifying the part of the current screen.



- ⑰  Timer : Use a stopwatch.
- ⑱  Eye protection : Operates the blue light blocking function.

7.1 Shortcuts



19  Camera menu : Use the video conference feature of the camera app more conveniently.

- Voice mute : Block the array microphone function.
- Voice tracking : Recognizes the voice within the camera range and zooms in on the speaker.
- Auto frame : Recognize people within the camera range and expand to the maximum range.
- Echo : Improves sound quality through noise reduction.

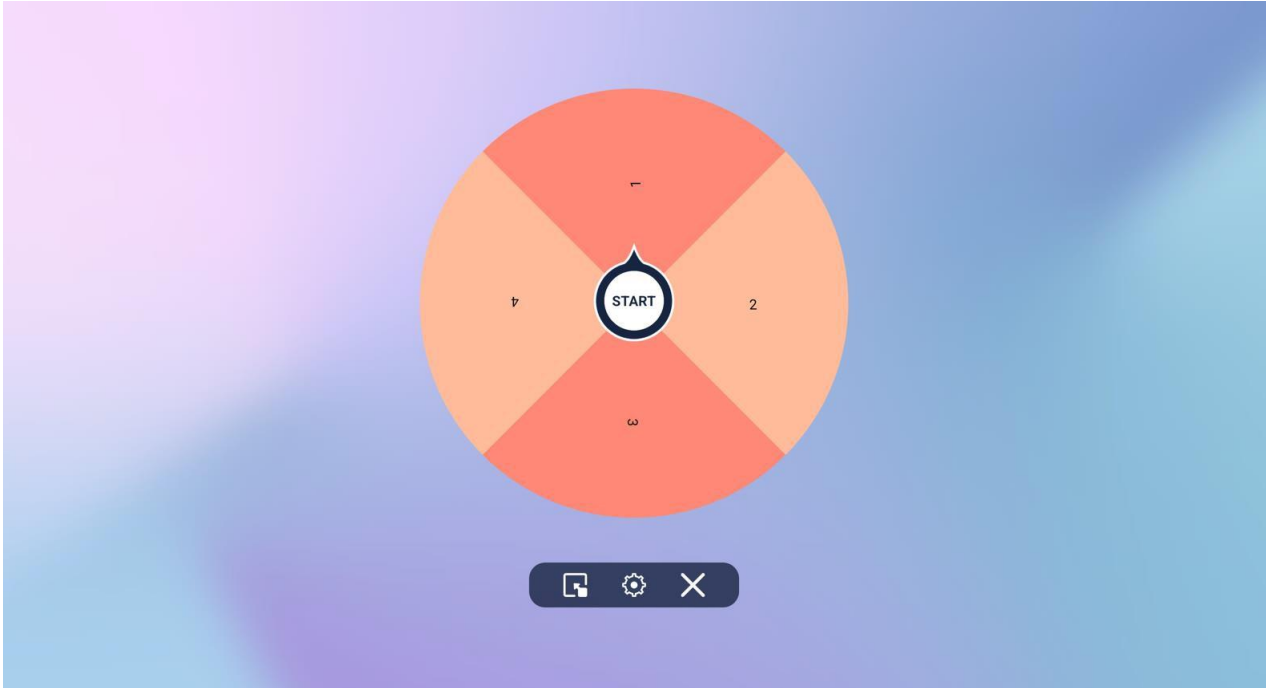

20  Spinner : You can use the spinner feature.

7.2 Recent tasks

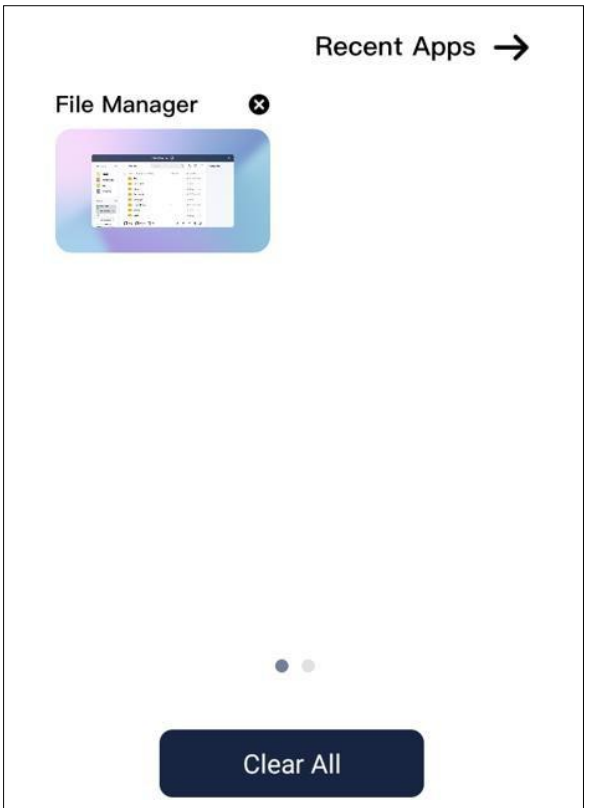
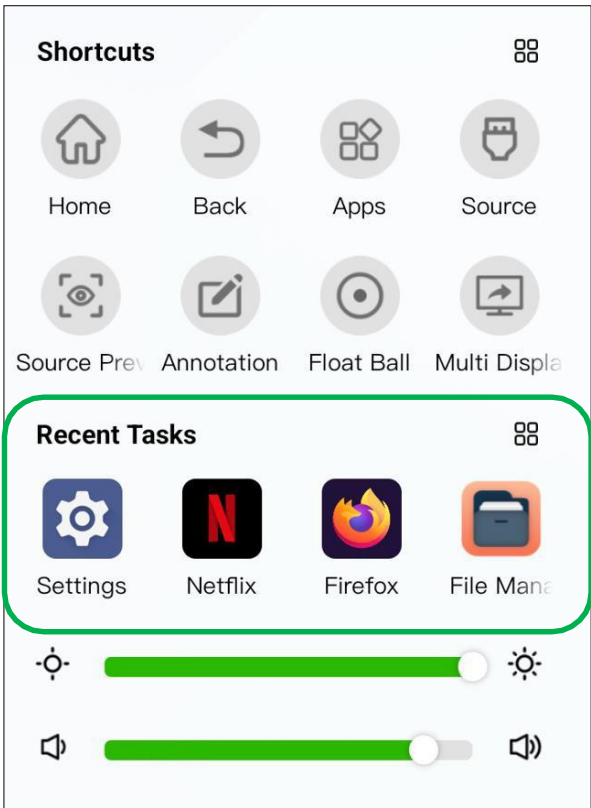

- Shows recently used apps.

-  Press the icon to check the currently running app and exit the running app.



7.3 Brightness & volume control

- Adjust the brightness and volume of the device at the bottom of the side menu

8. Etc app

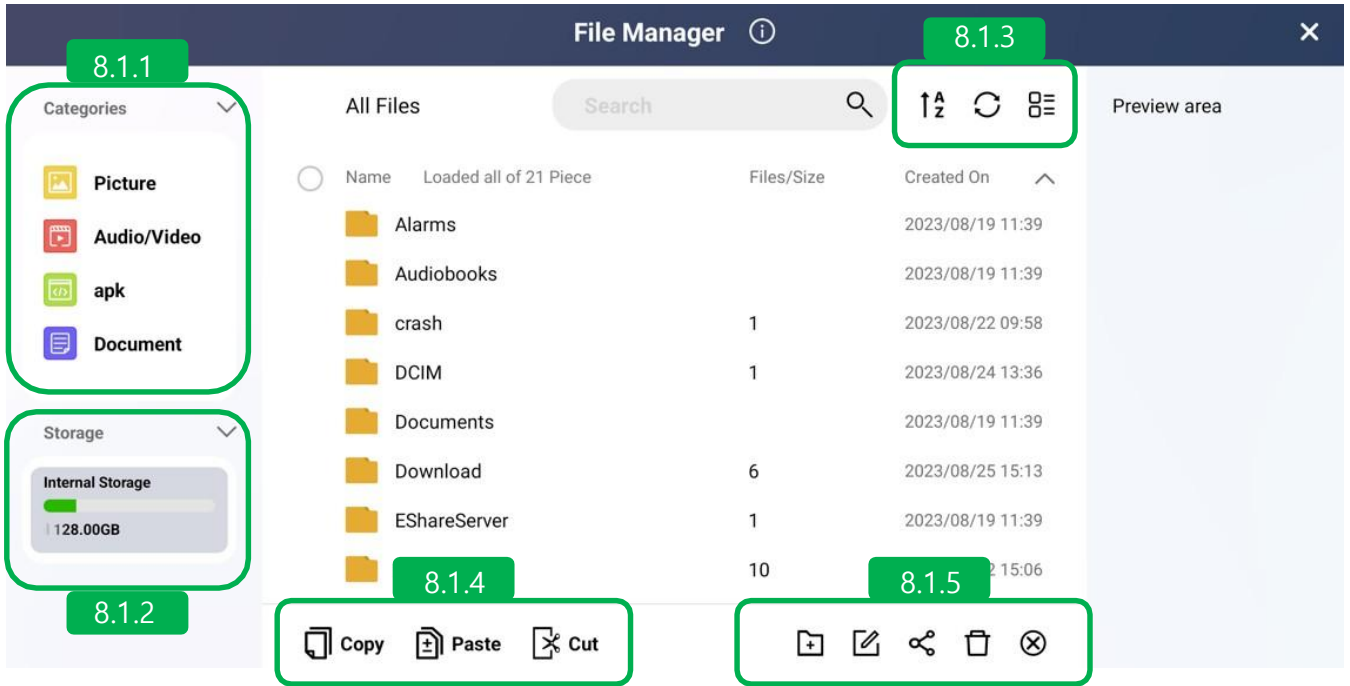

8.1 File manager

- Manage storage files on the device.

8.1.1 Categories

- Shows the file by selecting the extension users want.

8.1.2 Storage

- Shows the default and additional detected storage for the device.

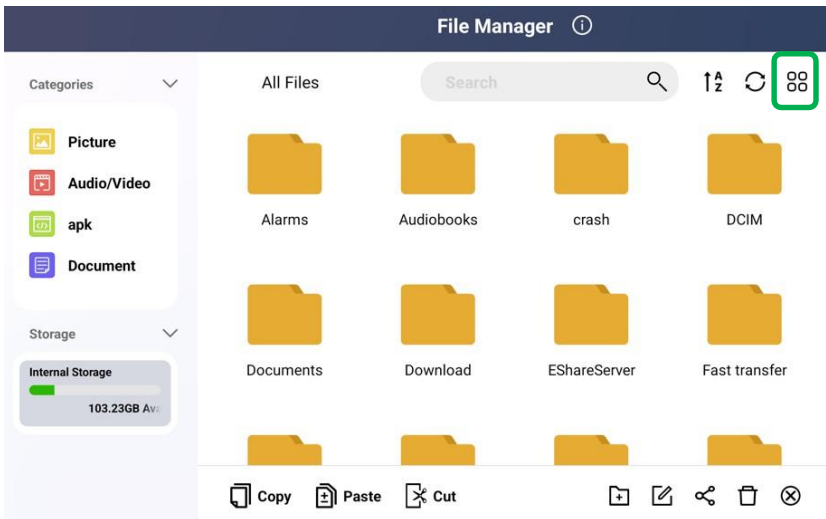

8.1.3 File sort

-  Press the button to enlarge the file icon or arrange the contents for a more detailed view.

8.1 File manager

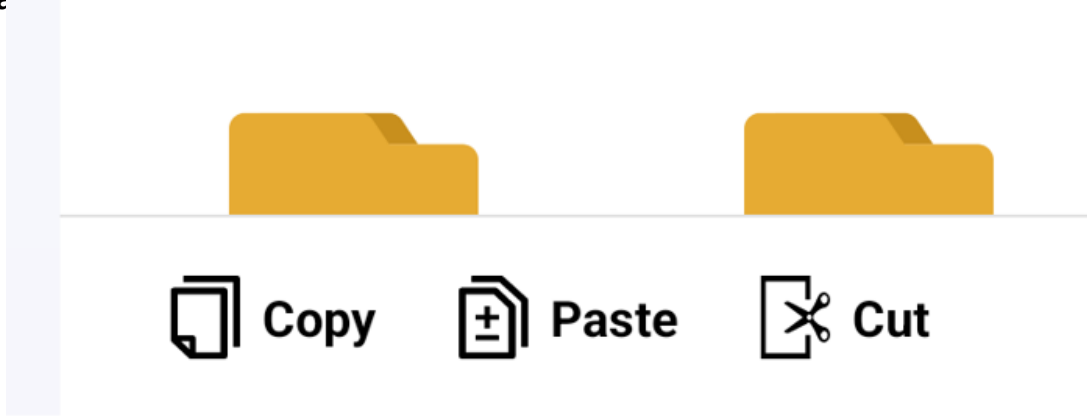

8.1.4 File edit_1

- Copy : Copy the selected file.
- Paste : Put the copied file in another folder or another storage.
- Cut : Cut the selected file and place it in a different folder or in a different store.
(Files disappear from existing storage)

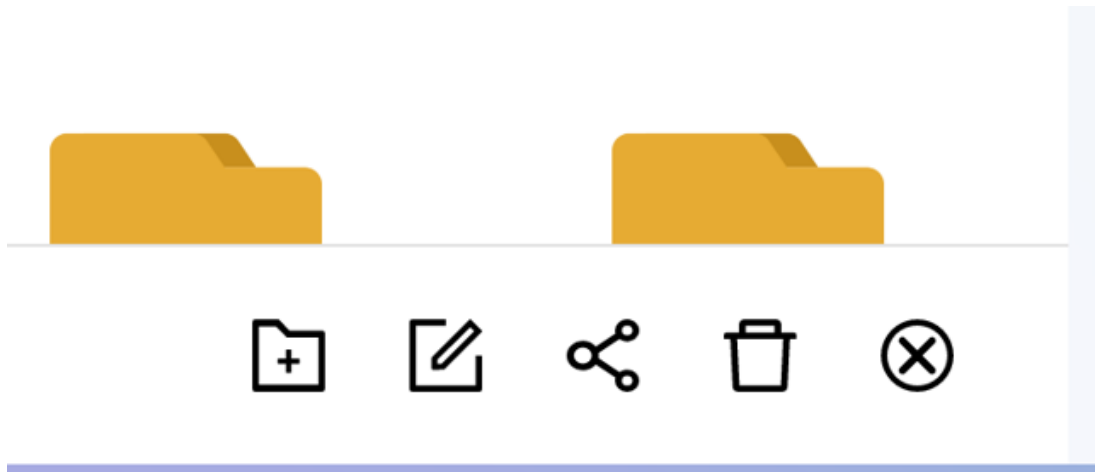

8.1.5 File edit_2

- New Folder: Creates a new file.
- Edit filename: Select a file or folder to edit its name.
- Share: Share the selected file by email, etc..
- Delete: Delete the selected file or folder.
- Cancel: Cancels a selection, copy, etc. on a file.

8.2 File Transfer

- Files from external devices can be quickly transferred to the inside of this device.

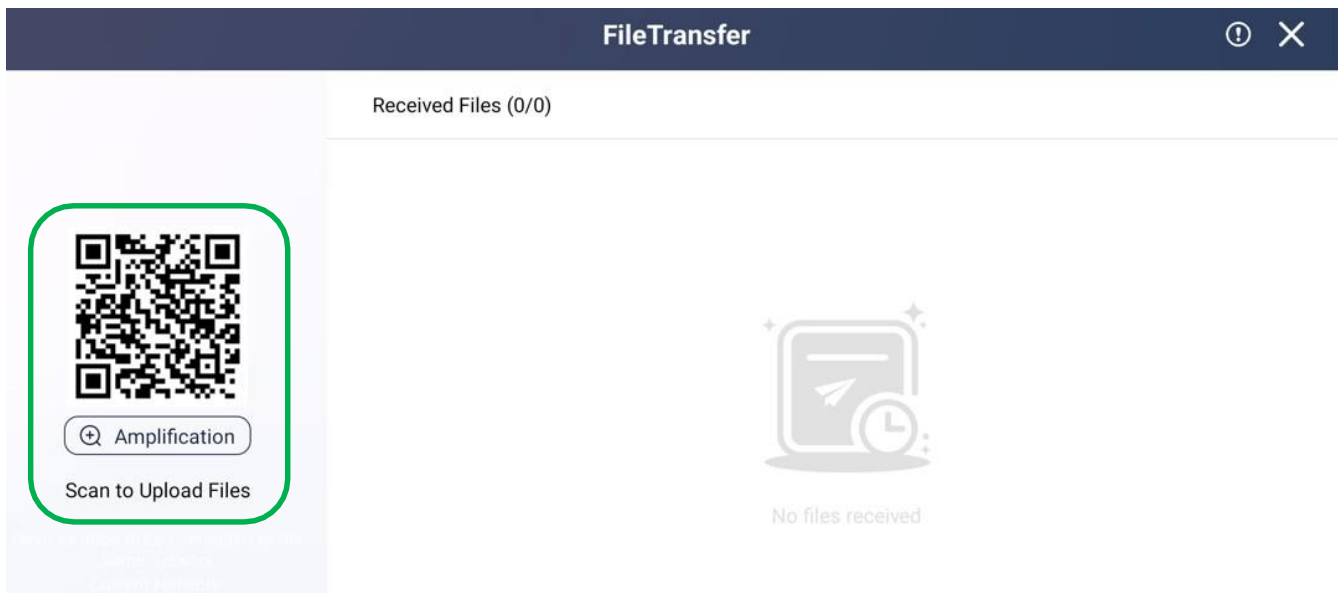

8.2.1 QR code Scan

- Scan the QR Code with an external device and upload multiple files from the external device immediately.

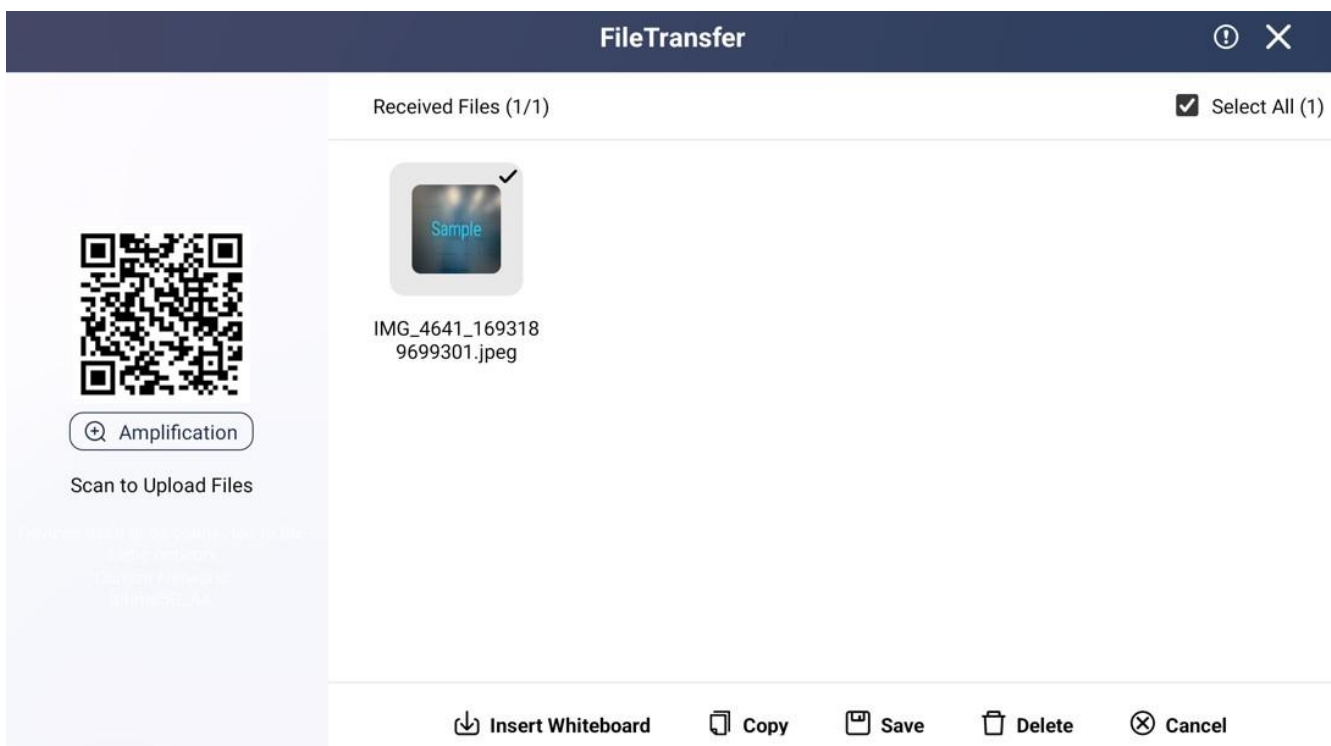

8.2.2 Managing uploaded files

- Insert Whiteboard : Immediately float the file on the whiteboard.
- Copy: Copy the uploaded file.
- Save : Save the uploaded file. (It will be saved in the File manager -> Fast transfer folder).
- Delete: Delete the uploaded file.
- Cancel: Cancels the file selection.

8.3 OTA Service

- Firmware upgrades can be done by the user.

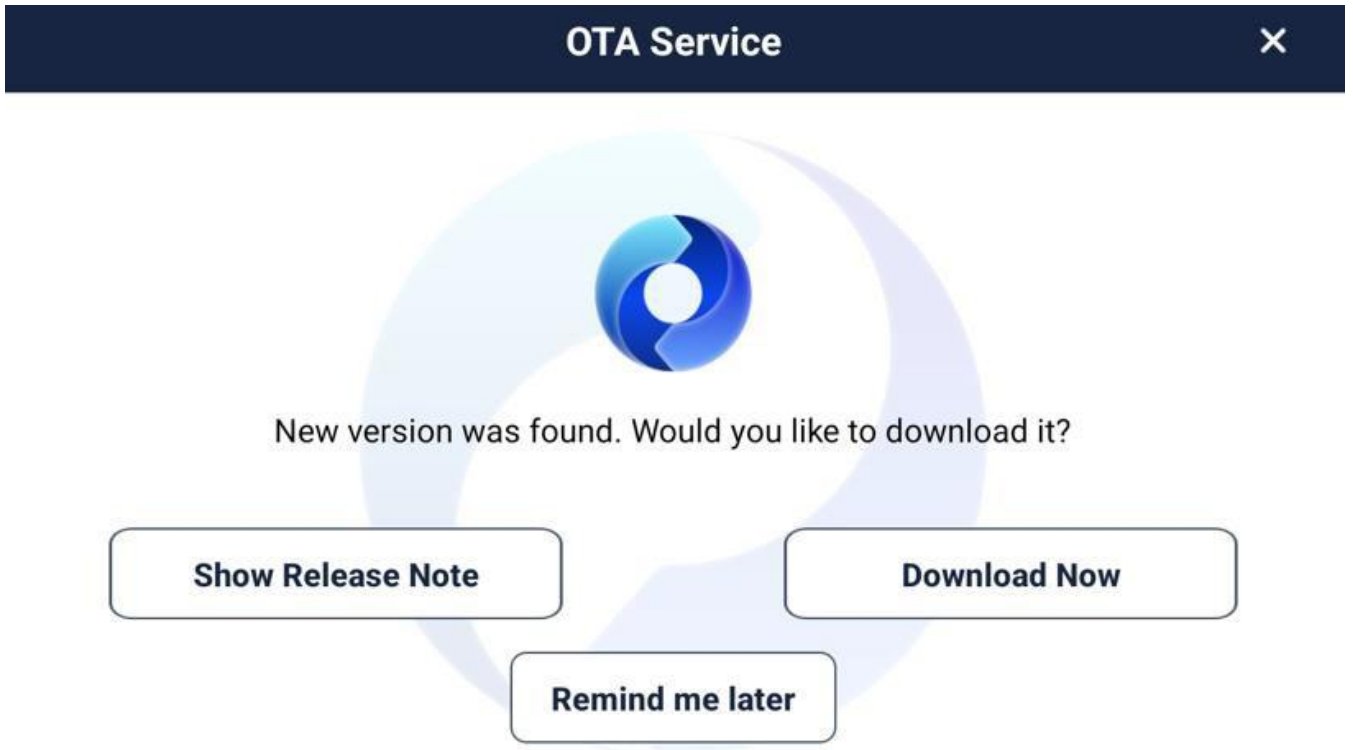

8.3.1 Upgrade notifications

- When the upper version of the firmware is released, the upgrade progress notification will be displayed automatically.
- Show release note : Shows the modification history of the firmware.
- Download now : Upgrade the firmware.
- Remind me later : Upgrades can be postponed, and users can proceed with upgrades manually at a later time.

8.3 OTA Service

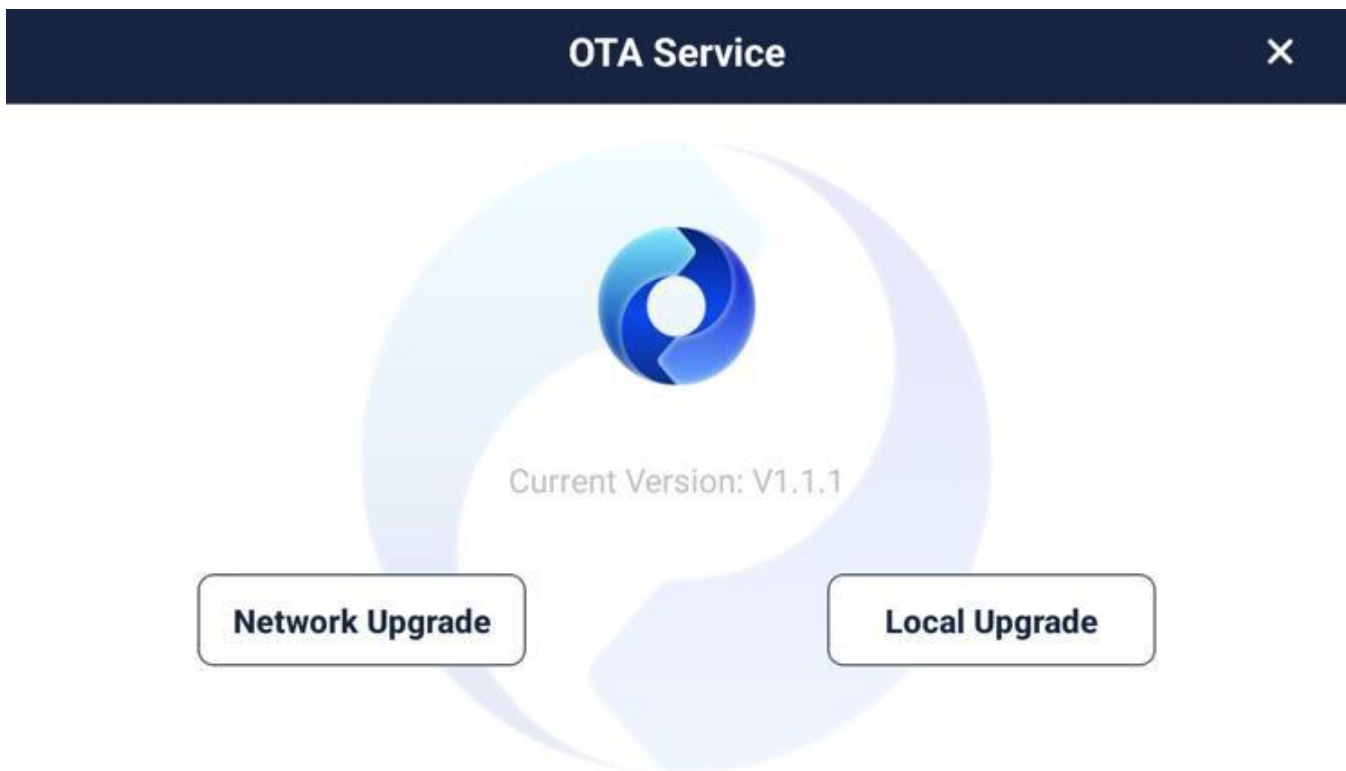

8.3.2 Manual upgrade

- Network upgrade : Proceed with the firmware upgrade while connected to the network.
- Local upgrade : Upgrade directly to the USB firmware file instead of the OTA service.

8.4 E-Share

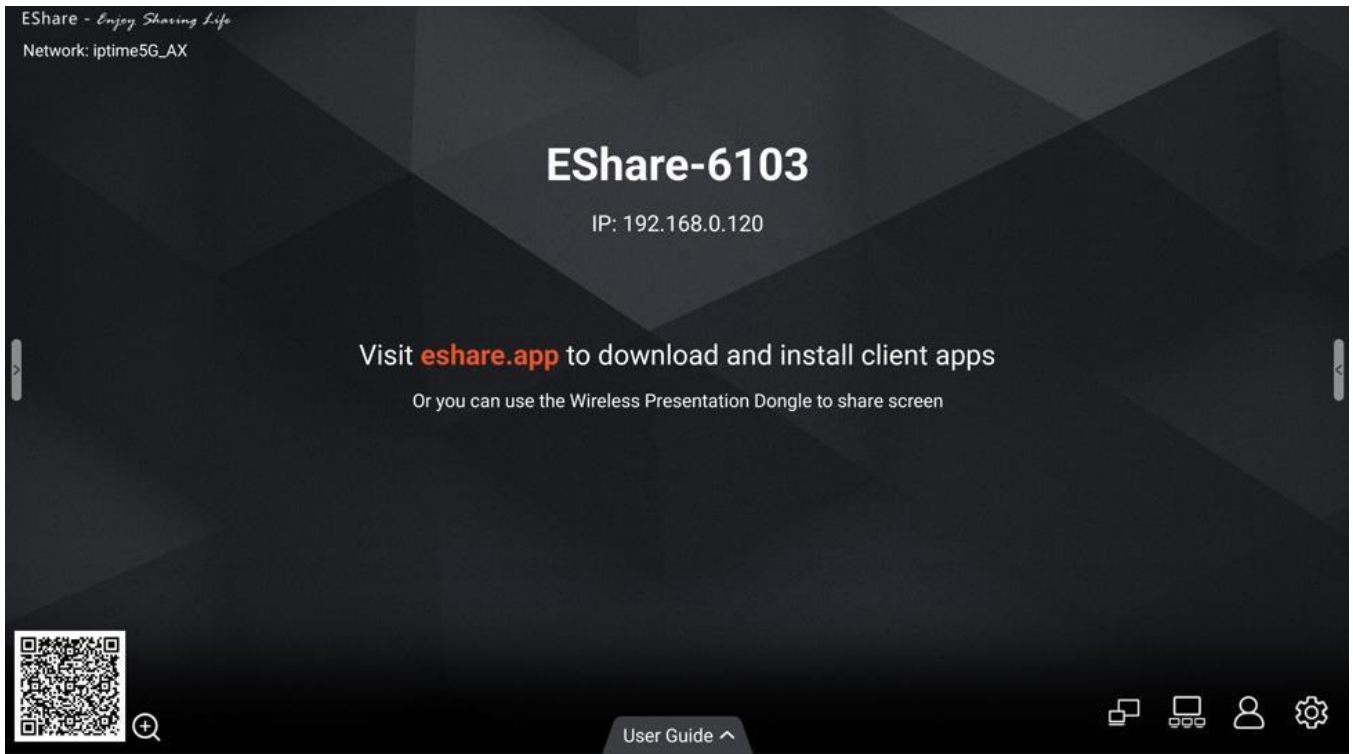

❖ E-Share

- Share the screen and voice through mirroring with external devices with the E-Share app.

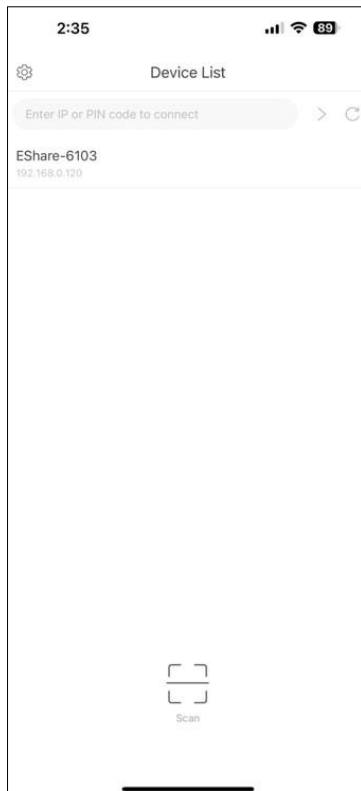

8.4.1 How to connect

- Connect this device and external device with the same network.
(External devices also have to run E-Share app)
- Share screen : Display the screen of the external device on this device.
- TV Mirror : Display the screen of this device on an external device.

9. Product dimension

9.1 65inch

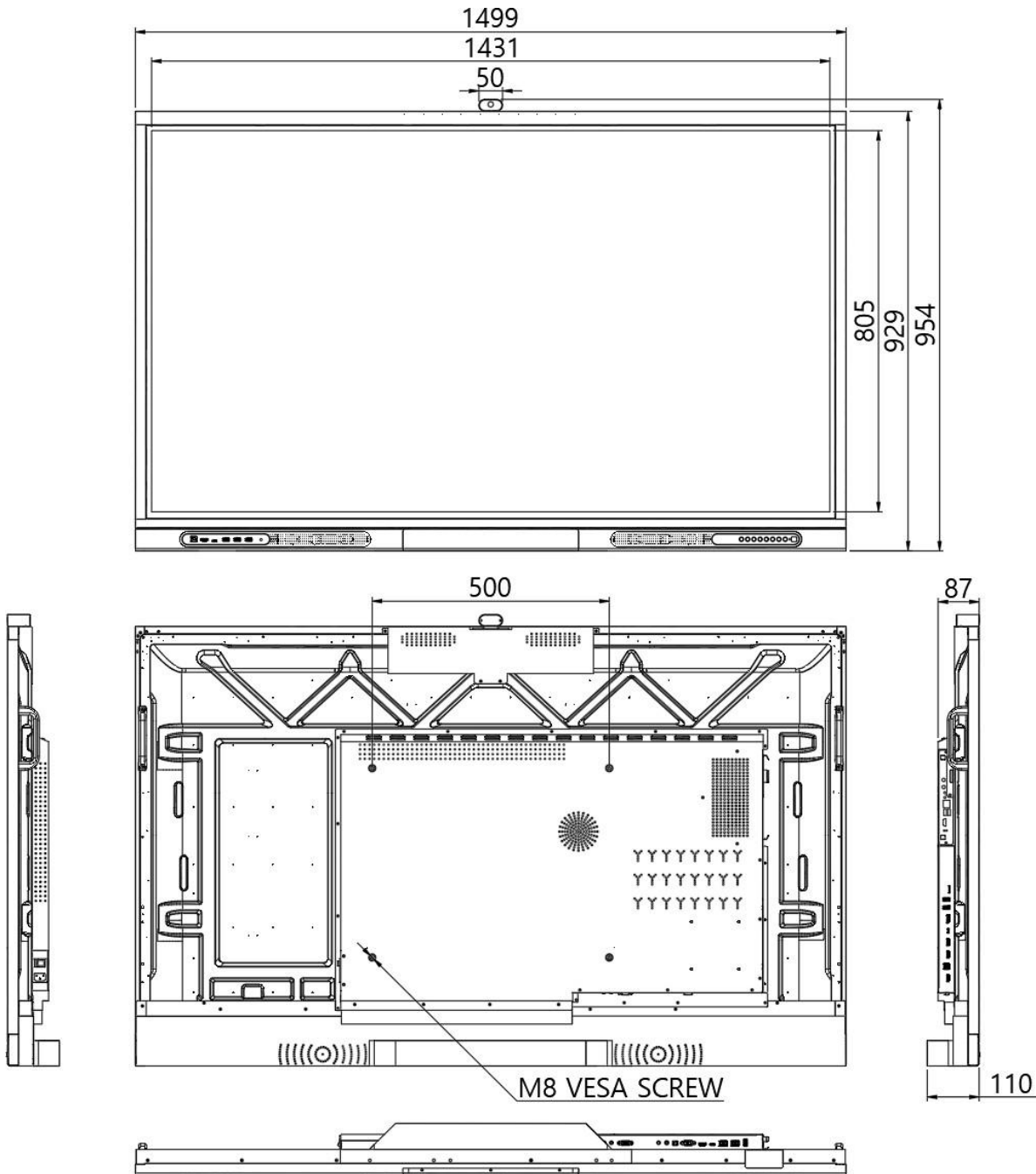

9. Product dimension

9.183 75inch

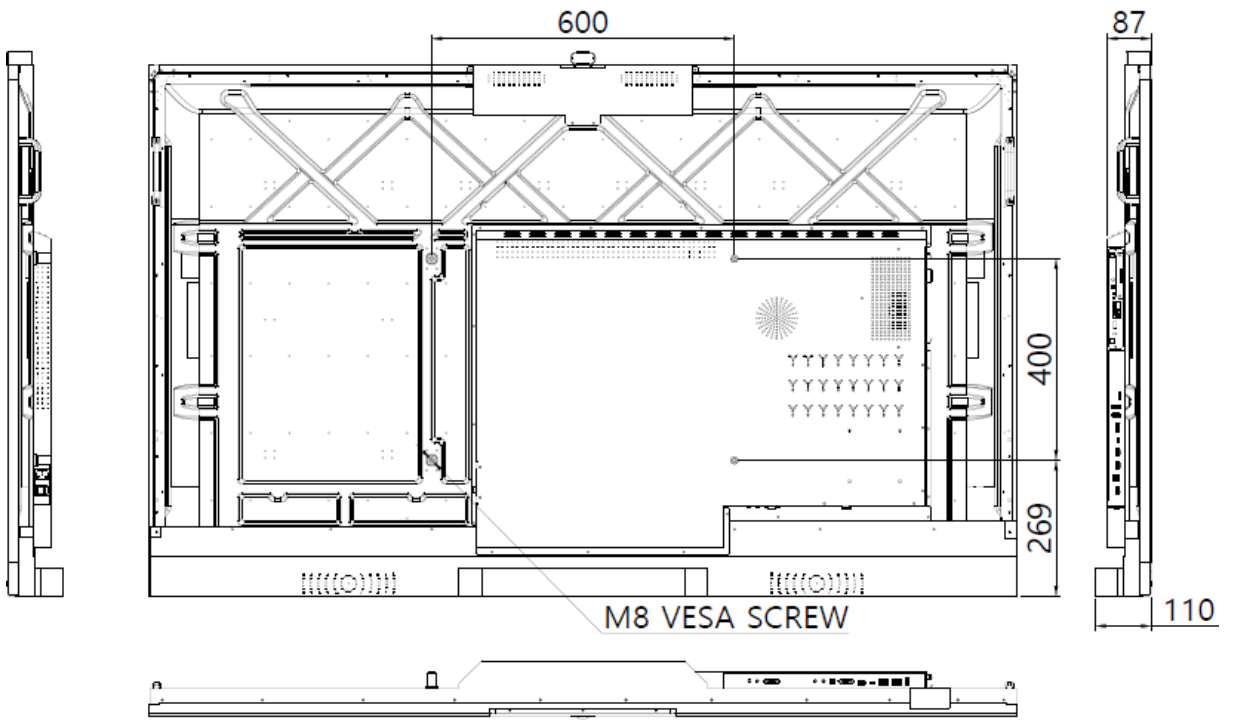
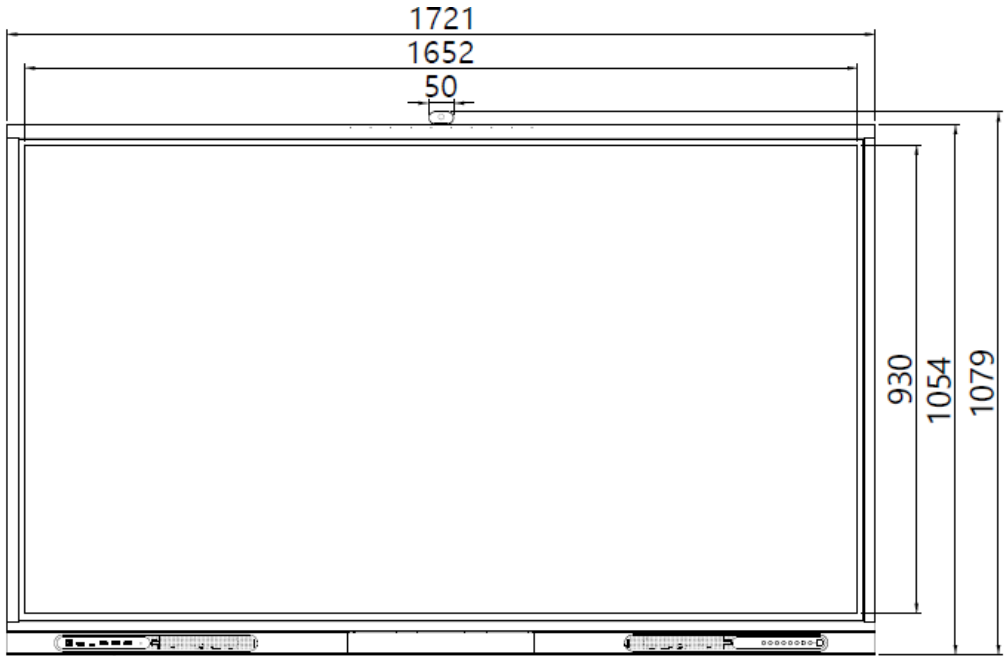

9. Product dimension

9.184 86inch

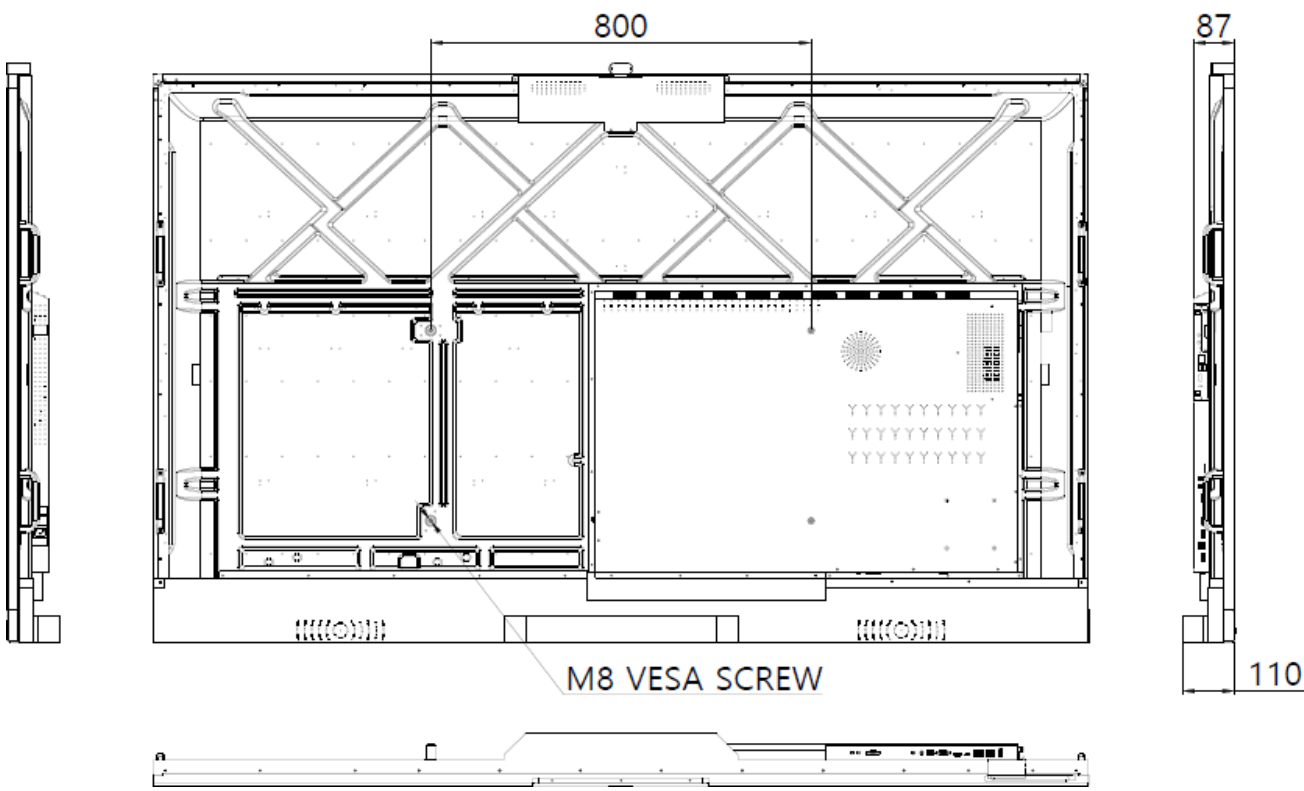
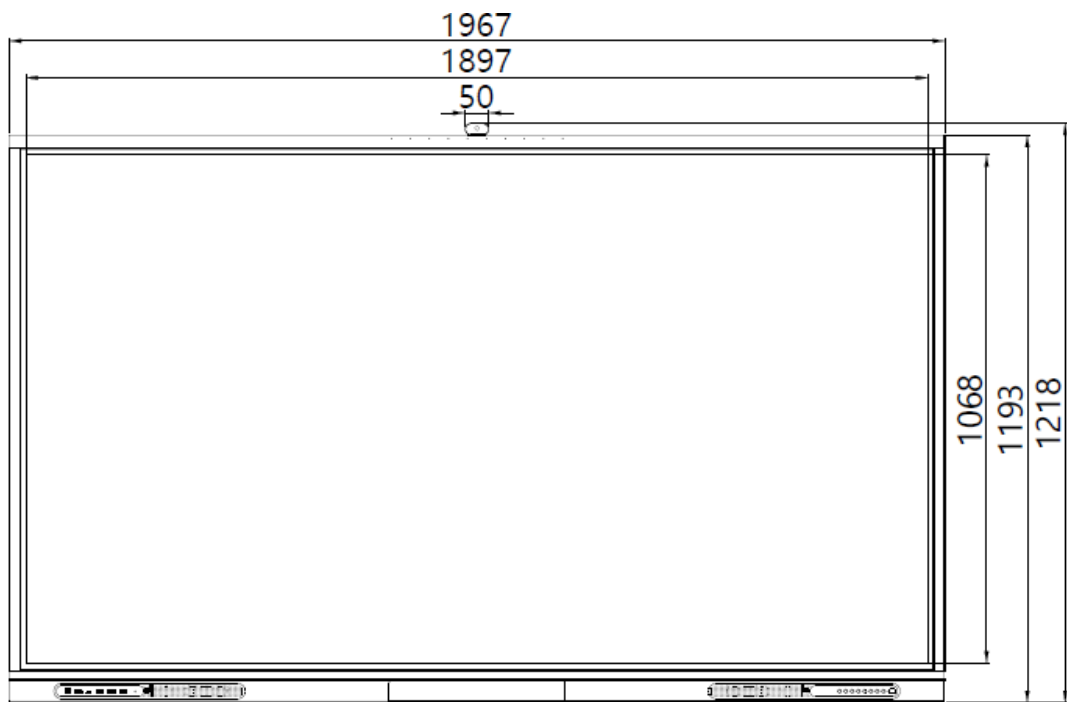

10. Product specification

10.1 65 Inch

Panel	
Display	65 Inch
Resolution	3840x2160
Brightness	410cd/m ² (Typ.)
Contrast	1100:1 (Typ.)
Glass	4T / AG+AF / Zero Gap

Touch System	
Touch Technology	IR (USIR-Ultra Slim Infrared Ray)
Touch Point	Max 40 Point (Windows, Android)
	1 Point (Mac, Linux, Chrome OS Single Point Support)
Response Speed	<3.3 ms (1 Point By Point)
Accuracy	± 0.5 mm
Operating System	Windows 10 more/ Android / Mac / Linux / Chrome

Android System	
Android Version	Android 13.0
CPU	(A76 x 4) + (A55 x Quad-4)
RAM	8GB
ROM	128GB

Detachable Camera And Microphone	
Image Sensor	SONY IMX214-0AQH5-C 13M (1/2.5", CMOS, Effective Pixel: 8.29M
Resolution	3840x2160@30fps
lens Viewing Angle	D:123° H:99.8° V:80.8° (aperture 2.2±5%)
Array Microphone	10-Ch Array Mic, Pick up 8m
Camera Function	Auto Framing, Noise Reduction

I/O Port	
Front (Input)	USB-B(Touch) x 1, HDMI 2.0 x 1, USB-C(DP Alt Mode) x 1, USB-A(3.0) x 3
Rear (Input & Output)	HDMI(2.0) x 2, USB-C x 1(Only Data), USB-B(2.0) x 1(Touch for HDMI)
	DP(1.2) x 1, USB-B(2.0) x 1(Touch for DP), USB-A(3.0) x 1
	VGA x 1, AV IN x 1, AUDIO IN x 1, LINE IN(3.5mm) x 1
	HDMI(2.0) OUT x 1, LINE OUT(3.5mm) x 1, S/PDIF x 1
Communication Port	RS232C(D-SUB9) x 1, LAN IN/OUT(1G) x 2, NFC x 1

Power	
Rated Voltage	AC 100-240V 50/60 Hz
Maximum Power	≤ 280W
Standby Power	≤ 0.5W

Other	
Speaker Output	2.1 Ch - 16W x 2, 20W x 1 (Sub Woofer Speaker)
Dimension (WxHxD)	1499(W) x 929(H) x 110(D) mm
VESA Mount	500 x 400 (mm), M8 Screw
Net Weight	40 Kg
Gross Weight	54 Kg

10. Product specification

10.186 75 Inch

Panel	
Display	75 Inch
Resolution	3840×2160
Brightness	410cd/m ² (Typ.)
Contrast	5000:1 (Typ.)
Glass	4T / AG+AF / Zero Gap

Touch System	
Touch Technology	IR (USIR-Ultra Slim Infrared Ray)
Touch Point	Max 40 Point (Windows, Android)
	1 Point (Mac, Linux, Chrome OS Single Point Support)
Response Speed	<3.3 ms (1 Point By Point)
Accuracy	± 0.5 mm
Operating System	Windows 10 more/ Android / Mac / Linux / Chrome

Android System	
Android Version	Android 13.0
CPU	(A76 x 4) + (A55 x Quad-4)
RAM	8GB
ROM	128GB

Detachable Camera And Microphone	
Image Sensor	SONY IMX214-0AQH5-C 13M (1/2.5", CMOS, Effective Pixel: 8.29M
Resolution	3840x2160@30fps
lens Viewing Angle	D:123° H:99.8° V:80.8° (aperture 2.2±5%)
Array Microphone	10-Ch Array Mic, Pick up 8m
Camera Function	Auto Framing, Noise Reduction

I/O Port	
Front (Input)	USB-B(Touch) x 1, HDMI 2.0 x 1, USB-C(DP Alt Mode) x 1, USB-A(3.0) x 3
Rear (Input & Output)	HDMI(2.0) x 2, USB-C x 1(Only Data), USB-B(2.0) x 1(Touch for HDMI)
	DP(1.2) x 1, USB-B(2.0) x 1(Touch for DP), USB-A(3.0) x 1
	VGA x 1, AV IN x 1, AUDIO IN x 1, LINE IN(3.5mm) x 1
	HDMI(2.0) OUT x 1, LINE OUT(3.5mm) x 1, S/PDIF x 1
Communication Port	RS232C(D-SUB9) x 1, LAN IN/OUT(1G) x 2, NFC x 1

Power	
Rated Voltage	AC 100-240V 50/60 Hz
Maximum Power	≤ 330W
Standby Power	≤ 0.5W

Other	
Speaker Output	2.1 Ch - 16W x 2, 20W x 1 (Sub Woofer Speaker)
Dimension (WxHxD)	1721(W) x 1054(H) x 110(D) mm
VESA Mount	600 x 400 (mm), M8 Screw
Net Weight	55 Kg
Gross Weight	69 Kg

10. Product specification

10.187 86 Inch

Panel	
Display	86 Inch
Resolution	3840×2160
Brightness	410cd/m ² (Typ.)
Contrast	1200:1 (Typ.)
Glass	4T / AG+AF / Zero Gap

Touch System	
Touch Technology	IR (USIR-Ultra Slim Infrared Ray)
Touch Point	Max 40 Point (Windows, Android)
	1 Point (Mac, Linux, Chrome OS Single Point Support)
Response Speed	<3.3 ms (1 Point By Point)
Accuracy	± 0.5 mm
Operating System	Windows 10 more/ Android / Mac / Linux / Chrome

Android System	
Android Version	Android 13.0
CPU	(A76 x 4) + (A55 x Quad-4)
RAM	8GB
ROM	128GB

Detachable Camera And Microphone	
Image Sensor	SONY IMX214-0AQH5-C 13M (1/2.5", CMOS, Effective Pixel: 8.29M
Resolution	3840x2160@30fps
lens Viewing Angle	D:123° H:99.8° V:80.8° (aperture 2.2±5%)
Array Microphone	10-Ch Array Mic, Pick up 8m
Camera Function	Auto Framing, Noise Reduction

I/O Port	
Front (Input)	USB-B(Touch) x 1, HDMI 2.0 x 1, USB-C(DP Alt Mode) x 1, USB-A(3.0) x 3
Rear (Input & Output)	HDMI(2.0) x 2, USB-C x 1(Only Data), USB-B(2.0) x 1(Touch for HDMI)
	DP(1.2) x 1, USB-B(2.0) x 1(Touch for DP), USB-A(3.0) x 1
	VGA x 1, AV IN x 1, AUDIO IN x 1, LINE IN(3.5mm) x 1
	HDMI(2.0) OUT x 1, LINE OUT(3.5mm) x 1, S/PDIF x 1
Communication Port	RS232C(D-SUB9) x 1, LAN IN/OUT(1G) x 2, NFC x 1

Power	
Rated Voltage	AC 100-240V 50/60 Hz
Maximum Power	≤ 440W
Standby Power	≤ 0.5W

Other	
Speaker Output	2.1 Ch - 16W x 2, 20W x 1 (Sub Woofer Speaker)
Dimension (WxHxD)	1967(W) x 1193(H) x 110(D) mm
VESA Mount	800 x 400 (mm), M8 Screw
Net Weight	71 Kg
Gross Weight	86 Kg

External Control

This chapter provides information on external control setup for room control systems. RS232 and TCP/IP control options are supported.

RS232 Connection and Port Configuration

Connect your control system or PC to the RS232 input of the display via a 9-pin male-to-female crossover connector cable, and set the baud rate to 38400, Data Bit: 8 bit, Stop Bit: 1 bit, Parity Bit: No Parity.

TCP/IP Control Configuration

Connect your network, control system, or PC to the display's LAN port via a CAT5 cable. This display must be connected to the network and must have a valid IP address. Configure your control device to run through **PORT 59595**.

RS232 ID

The **RS232 ID** sets bytes 4 and 5 in the HEX code, and is the second byte in the ASCII code. This ID is set to "00" by default, but can be changed from 00~99. This RS232 ID can be changed in the Android settings: **Settings>Advanced Features>RS232 ID**

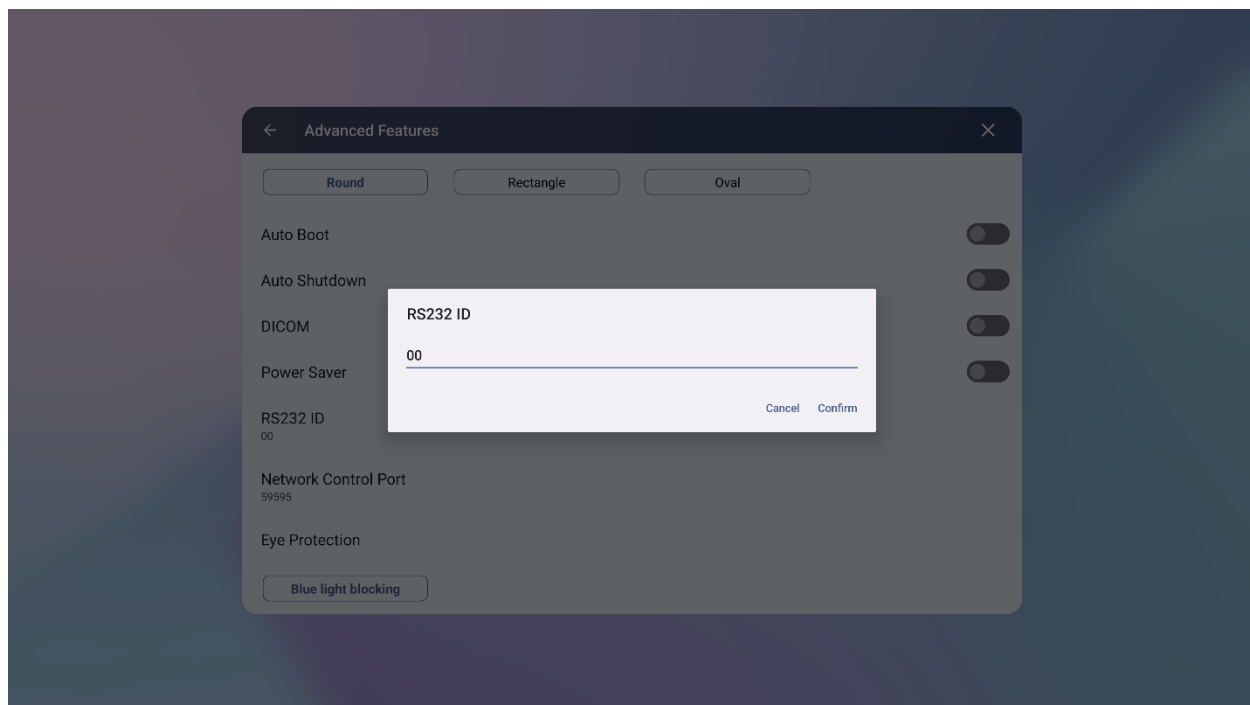

Example Commands

Usage of the RS232 ID demonstrating by with the "Power On" command:

RS232 ID	Power On (Hex)	Power On (ASCII)
00	6b 61 20 30 30 30 20 30 31	ka 00 01
17	6b 61 20 31 37 37 20 30 31	ka 17 01

Usage of a set command with a 0-100% value demonstrated with the "Set Volume" command:

RS232 ID	Desired Volume	Set Volume (Hex)	Set Volume (ASCII)
00	0% (Hex = 00)	6b 66 20 30 30 30 20 30 30	kf 00 00
00	50% (Hex = 32)	6b 66 20 30 30 30 20 33 32	kf 00 32
00	100% (Hex = 64)	6b 66 20 30 30 30 20 36 34	kf 00 64

Serial Command List

Input either the HEX or ASCII code as it correlates to the display's **RS232 ID**.

Event		Value	HEX	ASCII
Power		ON	6b 61 20 3X 3X 20 30 31	ka XX 01
		OFF	6b 61 20 3X 3X 20 30 30	ka XX 00
		Read	6b 61 20 3X 3X 20 66 66	ka XX ff
Source		HOME	6b 62 20 3X 3X 20 30 30	kb XX 00
		OPS	6b 62 20 3X 3X 20 30 37	kb XX 07
		FRONT HDMI	6b 62 20 3X 3X 20 30 38	kb XX 08
		HDMI 1	6b 62 20 3X 3X 20 30 39	kb XX 09
		HDMI 2	6b 62 20 3X 3X 20 30 61	kb XX 0a
		HDMI 3	6b 62 20 3X 3X 20 30 62	kb XX 0b
		DP	6b 62 20 3X 3X 20 30 63	kb XX 0c
		USB-C	6b 62 20 3X 3X 20 30 64	kb XX 0d
		FRONT USB-C	6b 62 20 3X 3X 20 30 65	kb XX 0e
		Read	6b 62 20 3X 3X 20 66 66	kb XX ff
Aspect Ratio		16:9	6b 63 20 3X 3X 20 30 31	kc XX 00
		4:3	6b 63 20 3X 3X 20 30 32	kc XX 01

		P2P	6b 63 20 3X 3X 20 30 35	kc XX 02
		Read	6b 63 20 3X 3X 20 66 66	kc XX ff
Picture	Picture Mode	Standard	6b 75 20 3X 3X 20 30 30	ku XX 00
		Soft	6b 75 20 3X 3X 20 30 31	ku XX 01
		Bright	6b 75 20 3X 3X 20 30 32	ku XX 02
		Read	6b 75 20 3X 3X 20 66 66	ku XX ff
	Contrast	Set	6b 67 20 3X 3X 20 3Y 3Y YY = (00~64)	kg XX YY YY = (00~64)
		Read	6b 67 20 3X 3X 20 66 66	kg XX ff
	Brightness	Set	6b 68 20 3X 3X 20 3Y 3Y YY = (00~64)	kh XX YY YY = (00~64)
		Read	6b 68 20 3X 3X 20 66 66	kh XX ff
	Saturation	Set	6b 69 20 3X 3X 20 3Y 3Y YY = (00~64)	ki XX YY YY = (00~64)
		Read	6b 69 20 3X 3X 20 66 66	ki XX ff
	Hue	Set	6b 6f 20 3X 3X 20 3Y 3Y YY = (00~64)	ko XX YY YY = (00~64)
		Read	6b 6f 20 3X 3X 20 66 66	ko XX ff
	Freeze	ON	6b 7a 20 3X 3X 20 30 31	kz XX 01
		OFF	6b 7a 20 3X 3X 20 30 30	kz XX 00
		Read	6b 7a 20 3X 3X 20 66 66	kz XX ff
	Sound	Mute	ON	6b 65 20 3X 3X 20 30 31
OFF			6b 65 20 3X 3X 20 30 30	ke XX 00
Read			6b 65 20 3X 3X 20 66 66	ke XX ff
Volume		Set	6b 66 20 3X 3X 20 3Y 3Y YY = (00~64)	kf XX YY YY = (00~64)
		Increase	6b 76 20 3X 3X 20 30 31	kv XX 01
		Decrease	6b 76 20 3X 3X 20 30 30	kv XX 00
		Read	6b 66 20 3X 3X 20 66 66	kf XX ff
Remote & Keypad	Button Input	OK	6d 63 20 3X 3X 20 38 63	mc XX 8c
		Up	6d 63 20 3X 3X 20 38 64	mc XX 8d
		Down	6d 63 20 3X 3X 20 38 65	mc XX 8e

		Left	6d 63 20 3X 3X 20 38 66	mc XX 8f
		Right	6d 63 20 3X 3X 20 38 30	mc XX 90
		Menu	6d 63 20 3X 3X 20 39 35	mc XX 95
		Exit	6d 63 20 3X 3X 20 39 36	mc XX 96
		Source	6d 63 20 3X 3X 20 61 63	mc XX ac
	Remote Lock	ON	6d 73 20 3X 3X 20 30 31	ms XX 01
		OFF	6d 73 20 3X 3X 20 30 30	ms XX 00
		Read	6d 73 20 3X 3X 20 66 66	ms XX ff
	Keypad Lock	ON	6d 6f 20 3X 3X 20 30 31	mo XX 01
		OFF	6d 6f 20 3X 3X 20 30 31	mo XX 00
		Read	6d 6f 20 3X 3X 20 66 66	mo XX ff

11. Troubleshooting

11.1 Product self-diagnosis

- You can check if the product is working properly using the self-diagnosis function.
- If a blank screen is displayed and the Power LED blinks even if the product and the PC are properly connected, perform the self-diagnosis function according to the procedures below.
 - ① Turn the product and the PC off.
 - ② Remove the cable from the product.
 - ③ Turn the product on.
 - ④ If the product is working properly, the <Check Signal Cable> message appears. In this case, if a blank screen is displayed again, make sure that there is no problem with the PC and the connector.

11.2 Before requesting service

- Please check the following before requesting After-Sales service.
If the problem continues, please contact your nearest Service Center.

11.2.1 Problems related to screen

- ① Screen is blank and power indicator is off.
 - Ensure that the power cord is firmly connected and the monitor is on.
- ② <Video media error format unsupported> Message.
 - Check the maximum resolution and the frequency of the video adapter.
 - Compare these values with the data in the Standard Signal Mode Table.
- ③ Picture rolls vertically.
 - Check if the signal cable is securely connected. Connect it again securely.
- ④ Image is not clear. Picture is blurred.
 - Run frequency <Coarse> and <Fine> tuning.
 - Turn on again after removing all accessories (video extension cable, etc.)
 - Set resolution and frequency to the recommended ranges.
- ⑤ The image is too light or too dark.
 - Adjust the <Brightness> and <Contrast>.

11.2.2 Problems related to audio

- ① No sound
 - Ensure that the audio cable is firmly connected to both the audio-in port on your monitor and the audio-out port on your sound card.
- ② The sound level is too low.
 - Check the volume level. If the volume is still too low after turning the control to its maximum. Check the volume control on the computer sound card or software program.

11.2.3 Problems related to remote controller

- ① The remote controller buttons do not respond.
 - Check the battery polarities (+/-).
 - Check if the batteries have been exhausted.
 - Check if the power is blackout.
 - Check if the power cord is securely connected.
 - Check if a special fluorescent or neon lamp is on in the vicinity.

Avocor: Three-year Limited Warranty

Congratulations on purchasing an Avocor E50-Series display! Avocor is pleased to extend the following limited warranty to the original end-user customer of our products.

Coverage

Avocor warrants to the first end user customer that the product, when shipped in its original container, will be free from defective workmanship and materials, and agrees that it will, for a period of **three (3) years** from the date of purchase, repair or replace the defective product or part thereof, at Avocor's discretion, with a new or equivalent at no charge to the customer. Advanced Field Replacement (AFR) service is included as part of this warranty. Except as specified herein, this warranty covers all defects in material or workmanship in the product. AVOCOR'S LIABILITY FOR ANY DEFECTIVE PRODUCT IS LIMITED TO THE REPAIR OR REPLACEMENT OF THE PRODUCT AT AVOCOR'S DISCRETION. REPLACEMENT PARTS OR PRODUCTS MAY BE NEW OR 'LIKE NEW' UNDER THE CONDITIONS SPECIFIED BELOW. All parts or products removed under this warranty become the property of Avocor. The replacement part or product is warranted for the remainder of the original limited warranty period or thirty days from shipment, whichever is longer.

LIMITATIONS ON WARRANTY COVERAGE, DURATION, AND SERVICES MAY SOMETIMES VARY BASED ON THE LAWS OF SPECIFIC REGIONS, STATES, AND COUNTRIES. THIS LIMITED WARRANTY GIVES YOU SPECIFIC LEGAL RIGHTS, AND YOU MAY HAVE OTHER RIGHTS WHICH VARY FROM JURISDICITON TO JURISDICTION.

Exclusions

This warranty does not apply to any cosmetic or consumable items of the Product or if the serial number or model number affixed to the Product has been removed, defaced, changed, altered or tampered with.

This warranty does not cover installation, signal reception problems, potential incompatibility with peripheral devices, or acts of nature. Avocor does not warrant nor shall it be liable for Products which have been subject to abuse, including, but not limited to, improper voltage, accident, misuse, negligence, lack of reasonable care, alteration, modification, tampering, improper installation, shipping damage, operation or maintenance or any damages or defects caused by repairs or attempted repairs performed by anyone other than Avocor personnel or an Avocor-authorized servicer. This warranty also excludes any damage to product glass due to pressure, abrasion, scratches, or actions otherwise beyond normal operation of the product that would cause screen mura and image retention. Please refer to Avocor's pixel policy for warranty guidelines on pixel related issues.

Concealed Damage

It is the customer's responsibility to inspect new product(s) at the time of delivery.

If packaging is found damaged *at the time of delivery*, the Customer should refuse delivery and note on the delivery receipt the product and details pertaining to damage. The Customer may accept packages with minor damage but must take note of product details and damage on the delivery receipt.

If patent or obvious physical damage is detected *after delivery is accepted* and a "clean" or unmarked delivery receipt was returned, it is the customer's responsibility to file an insurance claim to the shipping provider according to the requirements set forth in the shipping provider's policy.

If the product packaging is clean and undamaged, but patent or obvious physical damage is found on the product, the customer must report the damages to their product distributor, shipper, or seller, within the policy guidelines of the distributor, shipper, or seller.

If freight was arranged by Avocor, and patent or obvious physical damage to the packaging is not

detected but found on the product or product accessories upon inspecting the product, the customer must report the damages to Avocor within 10 calendar days after the delivery date to receive warranty services.

Customer Data

If the customer's product is capable of storing software programs, data, and other information, it is the customer's responsibility to protect its contents against operational failure. It is also the customer's responsibility to keep a separate backup of the contents and remove all personal information and disable security passwords prior to delivering a product for warranty service.

ANY PERSONAL CONTENT WILL BE DELETED AND STORAGE MEDIA WILL BE REFORMATTED IN THE COURSE OF WARRANTY SERVICE.

AVOCOR SHALL NOT BE LIABLE, OR IN ANY WAY RESPONSIBLE, FOR ANY INCIDENTAL OR CONSEQUENTIAL ECONOMIC OR PROPERTY DAMAGE. SOME REGIONS DO NOT ALLOW LIMITS ON WARRANTIES OR ON REMEDIES FOR BREACH IN CERTAIN TRANSACTIONS; IN SUCH REGIONS, THE LIMITS HEREIN MAY NOT APPLY. THIS WARRANTY IS IN LIEU OF ALL OTHER WARRANTIES, EXPRESSED OR IMPLIED. AVOCOR DISCLAIMS ALL OTHER WARRANTIES, EXPRESSED OR IMPLIED, INCLUDING, BUT NOT LIMITED TO, IMPLIED WARRANTIES OF NON-INFRINGEMENT, MERCHANTABILITY, AND FITNESS FOR A PARTICULAR PURPOSE.

Services

Technical Support: The Customer must contact Avocor Technical Support, via email at service@avocor.com in order to initiate an RMA or another warranty service. Customer agrees to cooperate with Avocor: (A) to notify Avocor promptly of any defect, error or Hardware Product malfunction and to submit to Avocor such information that Avocor may reasonably require to reproduce the error or Hardware Product malfunction was discovered; (B) to follow Avocor's guidelines to troubleshoot reported faults on the defective product(s); (C) to install, if requested by Avocor and within Customer security guidelines, a network connection that will be made available to Avocor for the purpose of resolving problems, reviewing Customer use of software, or for any other reasonable purpose; (D) to have a certified technician repair or replace defective parts under Avocor's guidance; (E) to notify Avocor of any additional hardware or software not purchased from Avocor that may be used in conjunction with the Hardware Product.

Onsite Repair: If Avocor deems the Product repairable, it will, at its discretion, send a technical support representative and/or technician to provide onsite repair or replacement service for any repairable or replaceable parts. Customer may be asked to provide access to, and to assist in the handling of, the Product, as deemed necessary by Avocor, under the instruction of the field representative or technician.

Advance Field Replacement (AFR): Avocor will ship a like-new or refurbished replacement product to the customer, at its discretion, if the product defect is determined to be unrepairable. The Customer must provide the display model and serial number and will be asked to provide contact details for the shipment. Upon approval, Avocor will ship the replacement product to the customer's site.

AFR Guidelines: At the time of the new product's arrival to the customer, it is the customer's responsibility to facilitate the deinstallation of the defective product, installation of the replacement product, and packing of the defective product in either its original packaging or the packaging of the replacement, and then send the defective back with the same driver that delivered the replacement product on that same day. If the customer is not able to perform the same-day swap they will incur the cost of freight. Additionally, if the product is not returned

within 15 business days, the customer will be invoiced in full for the replacement product.
SHIPMENTS TO CERTAIN INTERNATIONAL LOCATIONS MAY NOT BE SUBJECT TO THE ABOVE AFR GUIDELINES. CONTACT SUPPORT FOR FURTHER DETAILS.

Defective on Arrival (DOA): If the Product is determined by Avocor to be defective within the first 90 days of the initial purchase by the Customer, it is deemed Defective on Arrival (DOA). In the case of a DOA, the Customer will be provided a brand-new equivalent Product. In the case that an RMA is issued after the 90 DOA period, the defective product will be replaced with a refurbished "like new" equivalent product, if available.

Repair with Expired Warranty: Avocor offers repair services, at cost to the Customer based on time and materials, for products with expired warranty. Customer will be responsible for all shipment costs.

For more information, please email service@avocor.com.